



Introduction to Solitons

Ya Shnir

*Institute of Theoretical Physics and Astronomy
Vilnius, 2013*

KdV inverse scattering problem: examples

- One bound state: $N=1$, reflectionless potential: $R(k)=0$, $c_n(t) = c_n(0)e^{4\kappa_n^3 t}$

$$F(x, t) = \sum_{n=1}^N c_n^2 e^{-\kappa_n x} + \frac{1}{2\pi} \int_{-\infty}^{\infty} R(k, t) e^{ikx} dk \quad \rightarrow \quad F(x, t) = c^2(0) e^{-\kappa x + 8\kappa^3 t}$$

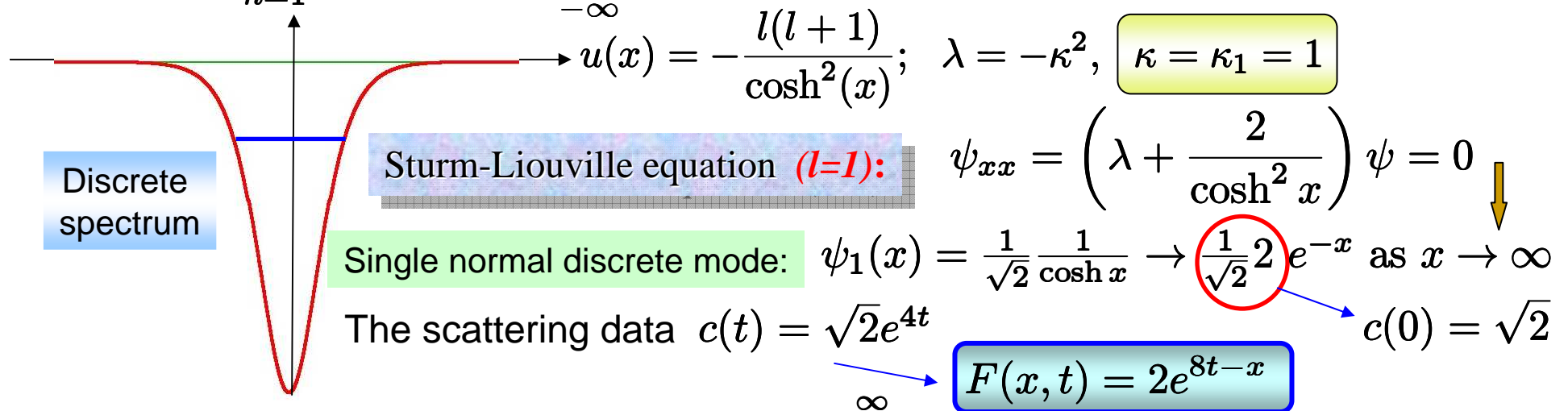

GLM equation: $K(x, y; t) + 2e^{8t-(x+y)} + 2 \int_x^{\infty} K(x, z; t) e^{8t-(y+z)} dz = 0$ $= \frac{1}{2} e^{-2x}$

Ansatz: $K(x, y, t) = M(x, t) e^{-y} \rightarrow M(x, t) + 2e^{8t-x} + 2M(x, t) e^{8t} \int_x^{\infty} e^{-2z} dz = 0$

$$M(x, t) = -\frac{2e^{8t-x}}{1 + e^{8t-2x}} \quad \rightarrow \quad u(x, t) = 2 \frac{\partial}{\partial x} K(x, x, t) = 2 \operatorname{sech}^2(x - 4t)$$

One-soliton solution propagating to the right

KdV inverse scattering problem: examples

- Two bound states: $N=2$, reflectionless potential: $R(k)=0$,

$$l(l+1) = 6; \quad \lambda = -k^2, \quad \kappa_1 = 1; \quad \kappa_2 = 2$$

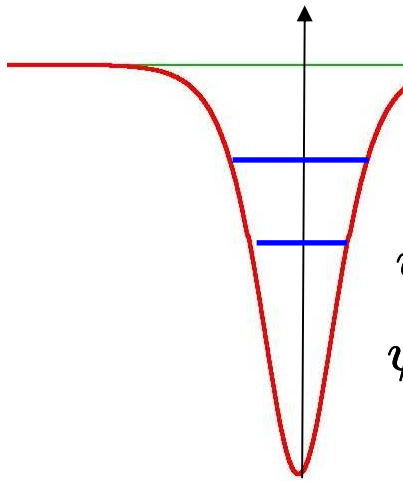

$$\psi_{xx} + \left(\lambda + \frac{6}{\cosh^2 x} \right) \psi = 0$$

Two normal discrete modes: ↓

$$\psi_1 = \sqrt{\frac{3}{2}} \frac{\tanh x}{\cosh x} \rightarrow \sqrt{6}e^{-x}$$

$$\psi_2 = \frac{\sqrt{3}}{2} \frac{1}{\cosh^2 x} \rightarrow 2\sqrt{3}e^{-x}$$

$$\begin{cases} c_1(0) = \sqrt{6} & \Rightarrow c_1(t) = \sqrt{6}e^{4t} \\ c_2(0) = 2\sqrt{3} & \Rightarrow c_2(t) = 2\sqrt{3}e^{32t} \end{cases}$$

$$F(x, t) = \sum_{n=1}^2 c_n^2 e^{-\kappa_n x} = 6e^{8t-x} + 12e^{64t-2x}$$

GLM equation:

$$K(x, y; t) + 6e^{8t-(x+y)} + 12e^{64t-2(x-y)} + \int_x^\infty K(x, z; t) \left\{ 6e^{8t-(y+z)} + 12e^{64t-2(y+z)} \right\} dz = 0$$

$$\text{Ansatz: } K(x, y, t) = M_1(x, t)e^{-y} + M_2(x, t)e^{-2y}$$

Collecting the coefficients at e^{-y} and e^{-2y}

$$\begin{cases} M_1 + 6e^{8t-x} + 6e^{8t} \left\{ M_1 \int_x^\infty e^{-2z} dz + M_2 \int_x^\infty e^{-3z} dz \right\} = 0 \\ M_2 + 12e^{64t-2x} + 12e^{64t} \left\{ M_1 \int_x^\infty e^{-3z} dz + M_2 \int_x^\infty e^{-4z} dz \right\} = 0 \end{cases}$$

2-soliton solution of the GLM equation:

$$K(x, x, t) = M_1(x, t)e^{-x} + M_2(x, t)e^{-2x}$$

$$\begin{cases} M_1(x, t) = \frac{6(e^{72t-5x} - e^{8t-x})}{1 + 3e^{8t-2x} + 3e^{64t-4x} + e^{72t-6x}} \\ M_2(x, t) = -\frac{12(e^{64t-2x} + e^{72t-4x})}{1 + 3e^{8t-2x} + 3e^{64t-4x} + e^{72t-6x}} \end{cases}$$

$$u_2 = 2 \frac{\partial}{\partial x} (M_1 e^{-x} + M_2 e^{-2x}) = -12 \frac{3 + 4 \cosh(2x - 8t) + \cosh(4x - 64t)}{[3 \cosh(x - 28t) + \cosh(3x - 36t)]^2}$$

Most general case: N-soliton solution

• N bound states, reflectionless potential: $R(k)=0 \implies F(x, t) = \sum_{n=1}^N c_n^2(t) e^{-\kappa_n x}$

The ansatz for the solution of the GLM equation: $K(x, y, t) = \sum_{n=1}^N M_n(x, t) e^{-\kappa_n y}$

KdV inverse scattering problem: N-soliton solution

The solution of the GLM equation is given by

$$u_N = 2 \frac{\partial^2}{\partial x^2} \ln \det A(x, t)$$

Here the $N \times N$ matrix A is defined as

$$A_{mn} = \delta_{mn} + \frac{c_n^2(0)}{\kappa_n + \kappa_m} e^{-(\kappa_n - \kappa_m)x + 8\kappa_n^3 t}$$

Asymptotically, as $t \rightarrow \pm\infty$ this solution of the KdV equation represents a superposition of N single-soliton solutions propagating to the right and ordered in space by their speeds (amplitudes):

$$u_N(x, t) \sim \sum_{n=1}^N 2\kappa_n^2 \operatorname{sech}^2[\kappa_n(x - 4\kappa_n^2 t - x_n^\pm)]$$

The position of the n -th soliton is given by:

$$x_n^\pm = \frac{1}{2\kappa_n} \ln \frac{c_n^2(0)}{2\kappa_n} \pm \frac{1}{2\kappa_n} \left\{ \sum_{m=1}^{n-1} \ln \left| \frac{\kappa_n - \kappa_m}{\kappa_n + \kappa_m} \right| - \sum_{m=n+1}^N \ln \left| \frac{\kappa_n - \kappa_m}{\kappa_n + \kappa_m} \right| \right\}$$

The N -soliton solution is characterised by $2N$ parameters: $\kappa_1 \dots \kappa_N, c_1(0), \dots, c_N(0)$

The evolution is isospectral, i.e. $\kappa_n = \text{const}$ - the solitons preserve their amplitudes (and velocities) in the interactions; the only change they undergo is an additional phase shift $\delta_n = x_n^+ - x_n^-$ due to collisions.

KdV solitons: 2-soliton solution

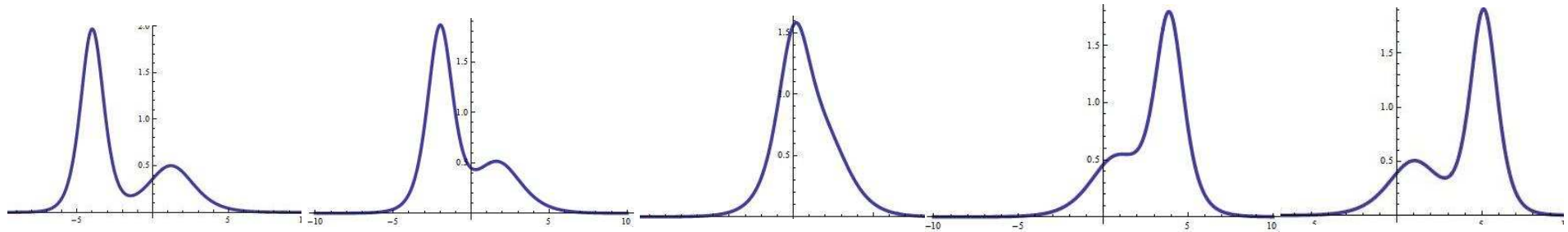

$$A(x, t) = 1 + \exp \{ \kappa_1(x - x_1) - 4\kappa_1^3 t \} + \exp \{ \kappa_2(x - x_2) - 4\kappa_2^3 t \} + \left(\frac{\kappa_1 - \kappa_2}{\kappa_1 + \kappa_2} \right)^2 \exp \{ \kappa_1(x - x_1) - 4\kappa_1^3 t + \kappa_2(x - x_2) - 4\kappa_2^3 t \}$$

$$u_2 = 2 \frac{\partial^2}{\partial x^2} \ln A(x, t)$$

Asymptotically, as $t \rightarrow \pm\infty$

$$u_2(x, t) \sim 2\kappa_1^2 \operatorname{sech}^2[\kappa_1(x - 4\kappa_1^2 t - x_1)] + 2\kappa_2^2 \operatorname{sech}^2[\kappa_2(x - 4\kappa_2^2 t - x_2)]$$

For a two-soliton collision the outcome is the phase shift ($\kappa_1 > \kappa_2$)

$$\delta_1 = 2x_1 = \frac{1}{\kappa_1} \ln \left(\frac{\kappa_1 + \kappa_2}{\kappa_1 - \kappa_2} \right), \quad \delta_2 = 2x_2 = -\frac{1}{\kappa_2} \ln \left(\frac{\kappa_1 + \kappa_2}{\kappa_1 - \kappa_2} \right)$$

As a result of the interaction, the taller soliton gets an additional shift forward by the distance δ_1 while the shorter soliton is shifted backwards by the distance $-\delta_2$.

KdV solitons: 2-soliton collision

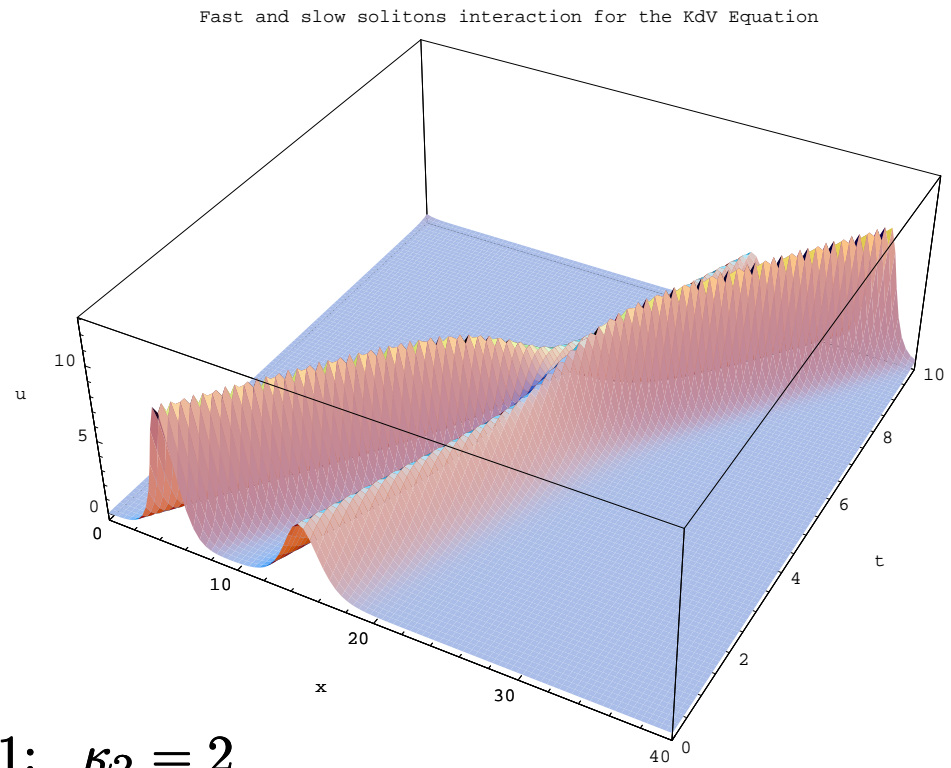
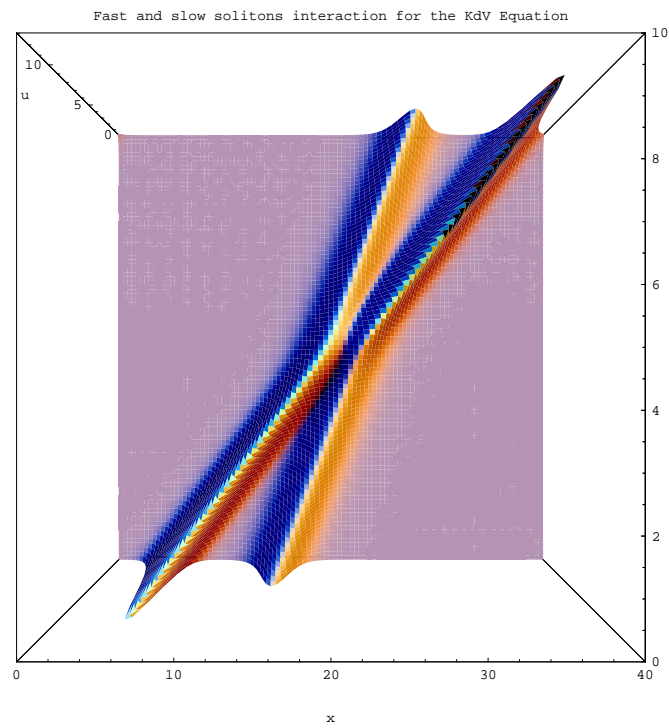
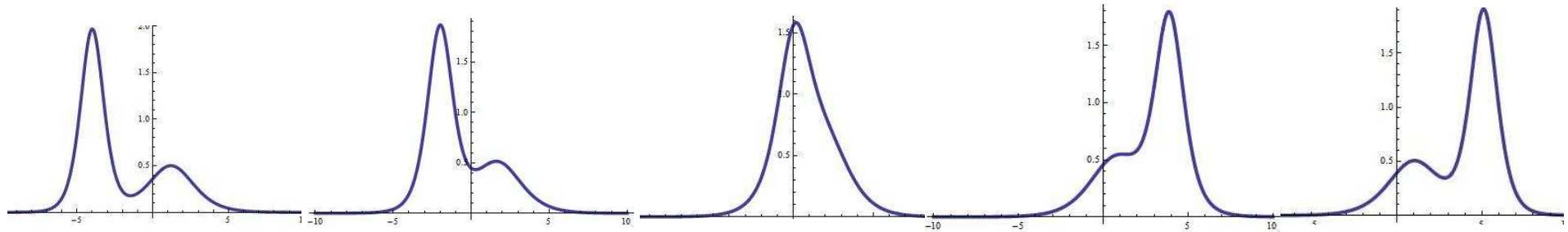

$$\kappa_1 = 1; \quad \kappa_2 = 2$$

KdV solitons: Hirota method

Another way around: Let us apply a different approach to find the 2-soliton solution

• **Step I:** Substitute into the KdV $u = v_x \Rightarrow u_t + 6uu_x + u_{xxx} = 0$

1-soliton KdV

$$u(\theta) = \frac{v}{2} \operatorname{sech}^2 \left(\frac{\sqrt{v}\theta}{2} \right)$$

$$\frac{\partial}{\partial x} (v_t + 3v_x^2 + v_{xxx}) = 0$$

Potential KdV equation:

$$v(\theta) = \sqrt{v} \left(\tanh \left[\frac{\sqrt{v}\theta}{2} + 1 \right] \right)$$

• **Step II:** Hirota substitution

$$= \sqrt{v} \left(\frac{2e^{\sqrt{v}\theta}}{e^{\sqrt{v}\theta} + 1} \right) = 2 \frac{\eta_x}{\eta}; \quad \eta = 1 + e^{\sqrt{v}\theta}$$

$$v = 2\eta_x / \eta = 2\partial_x \ln \eta$$

$$v_t + 3v_x^2 + v_{xxx} = 0$$

$$\eta_{xt}\eta - \eta_x\eta_t + \eta_{xxxx}\eta - 4\eta_x\eta_{xxx} + 3\eta_{xx}^2 = 0$$

Hirota form of KdV (bilinear equation)

Hirota's D-operator

$$D_x^n f \cdot g \equiv (\partial_{x_1} - \partial_{x_2})^n f(x_1)g(x_2) \Big|_{x_1=x_2=x} \equiv \partial_y^n f(x+y)g(x-y) \Big|_{y=0}$$

$$D_x^4 \eta \cdot \eta = 2(\eta_{xxxx}\eta - 4\eta_x\eta_{xxx} + 3\eta_{xx}^2)$$

$$D_x D_t \eta \cdot \eta = 2(\eta_{xt}\eta - \eta_x\eta_t)$$

$$(D_x^4 + D_x D_t) \eta \cdot \eta = 0$$

Hirota's bilinear operator

$$D_x^n f \cdot g \equiv (\partial_{x_1} - \partial_{x_2})^n f(x_1)g(x_2) \Big|_{x_1=x_2=x}$$

Note: the operator D acts on a product of 2 functions similar to the usual Leibniz rule, except for a crucial sign difference:

$$D_x f \cdot g = f_x g - f g_x$$

$$D_x D_t f \cdot g = f g_{xt} - f_x g_t - f_t g_x + f g_{xt}$$

$$D_x^2 f \cdot g = f_{xx} g - 2f_x g_x + g_{xx} f$$

How to construct the soliton solutions of KdV $D_x (D_t + D_x^3) \eta \cdot \eta = 0$?

Almost Perturbatively!

$$\kappa = \sqrt{v}$$

• Trivial solution: $\eta = 1$ • 1-soliton solution: $\eta = 1 + e^\theta$; $\theta = \kappa x - \kappa^3 t + \delta_0$

• 2-soliton solution: $\eta = 1 + e^{\theta_1} + e^{\theta_2} + a e^{\theta_1 + \theta_2}$ $\theta_1 = \kappa_1 x - \kappa_1^3 t + \delta_1^{(0)}$;
 $a = \left(\frac{\kappa_1 - \kappa_2}{\kappa_1 + \kappa_2} \right)^2$ $\theta_2 = \kappa_2 x - \kappa_2^3 t + \delta_2^{(0)}$

• N-soliton solution: $\eta = 1 + \sum_{n=1}^N \epsilon^n \eta_n(x, t)$ - expansion in powers of ϵ

$$\eta_1 = e^{\theta_1} - 1\text{-soliton}$$

$$\eta_1 = e^{\theta_1} + e^{\theta_2} - 2\text{-soliton}$$

$$\eta_1 = \sum_{i=1}^N e^{\theta_i} - N\text{-soliton}$$

Nonlinear Schrödinger Equation

Non-linear Schrödinger equation:

$$i\psi_t + \psi_{xx} + 2\sigma|\psi|^2\psi = 0$$

$$\sigma = \pm 1$$

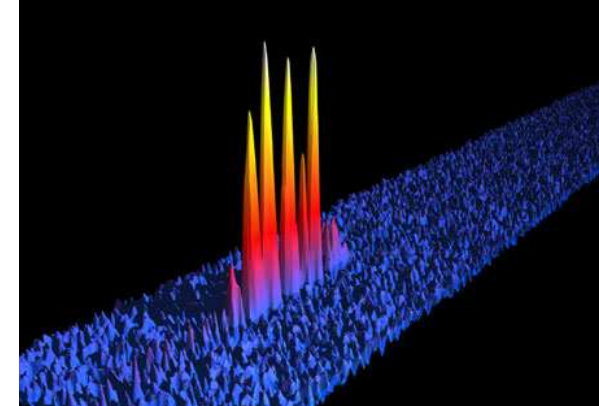
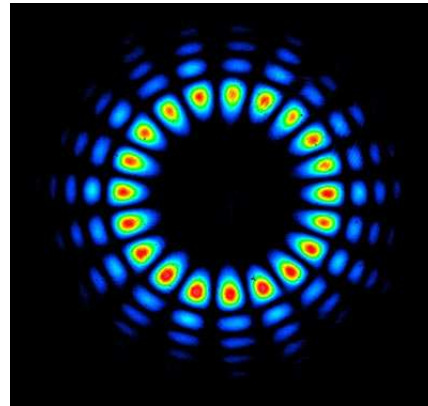

Lagrangian:

$$L = i(\psi\psi_t^* - \psi_t\psi^*) + \frac{1}{2}|\psi_x|^2 - \frac{\sigma}{2}|\psi|^4$$

Symmetries:

Hamiltonian:

$$H = \frac{1}{2}|\psi_x|^2 + \frac{\sigma}{2}|\psi|^4$$

• Translational invariance: $t \rightarrow t, x \rightarrow x + \delta x, \psi \rightarrow \psi$

• Time invariance: $t \rightarrow t + \delta t, x \rightarrow x, \psi \rightarrow \psi$

• Scale invariance: $t \rightarrow a^2 t, x \rightarrow ax, \psi \rightarrow \psi/a$

• Galilean invariance: $t \rightarrow t, x \rightarrow x - ct, \psi \rightarrow \psi e^{ic(x - \frac{c}{2}t)/2}$

One-parameter Lie group of symmetries

NSE Solitons

$$i\psi_t + \psi_{xx} + 2\sigma|\psi|^2\psi = 0$$

Ansatz for the soliton solution: $\psi(x, t) = u(x)e^{i\phi(t)}$

$$\rightarrow -u\phi_t + u_{xx} + 2\sigma u^3 = 0$$

$$\downarrow \frac{d\phi}{dt} = \frac{u_{xx}}{u} + 2\sigma u^2 = C = \text{const} \implies \phi = Ct$$

$$u_{xx} = -2\sigma u^3 + Cu \quad \times \text{integrating factor } u_x \rightarrow (u_x)^2 = -\sigma u^4 + Cu^2 + C_0$$

Shape of the solitary waves depends on the sign of σ

• **Bright Soliton: $\sigma=1$** (Focusing NLS) $(u_x)^2 = -u^4 + Cu^2 + C_0$

Boundary conditions: $u = u' = 0$, as $x \rightarrow \pm\infty$ $\rightarrow \int \frac{du}{u\sqrt{C-u^2}} = \int dx$

Simplest solution ($C=1$): $u = \text{sech } x$; $\phi = t \implies \psi = \text{sech } xe^{it}$ $-\ln\left(\frac{1+\sqrt{1-u^2}}{u}\right) = x$

Using Galilean and scale symmetry:

Homework: Consider $C=-1$

$$\psi = A \text{sech } A(x - ct)e^{i\left(\frac{c}{2}x + (A^2 - \frac{c^2}{4})t\right)}$$

Two-parameter family of bright solitons

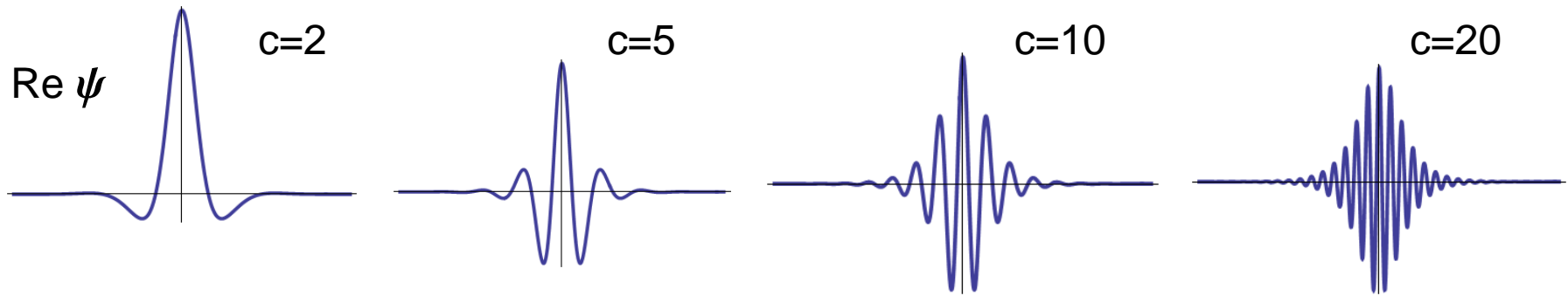

Instability of the bright soliton: for sufficiently large values of c the envelope has spatial oscillations of the same period as the carrier wave

• **Dark Soliton:** $\sigma=-1$ (Defocusing NLS)

$$(u_x)^2 = u^4 + Cu^2 + C_0$$

Simplest solution ($C=-1, C_0=1/4$): $\int \frac{du}{u^2 - \frac{1}{2}} = \int dx \rightarrow u = \frac{1}{\sqrt{2}} \tanh \frac{x}{\sqrt{2}}; \phi = -t$

$$\psi = \frac{1}{\sqrt{2}} \tanh \frac{x}{\sqrt{2}} e^{-it}$$

Homework: Consider $C=1$

Two-parameter family of dark solitons

Using Galilean and scale symmetry: $\psi = \frac{A}{\sqrt{2}} \tanh \frac{A(x - ct)}{\sqrt{2}} e^{i(\frac{c}{2}x(A^2 + \frac{c^2}{4})t)}$

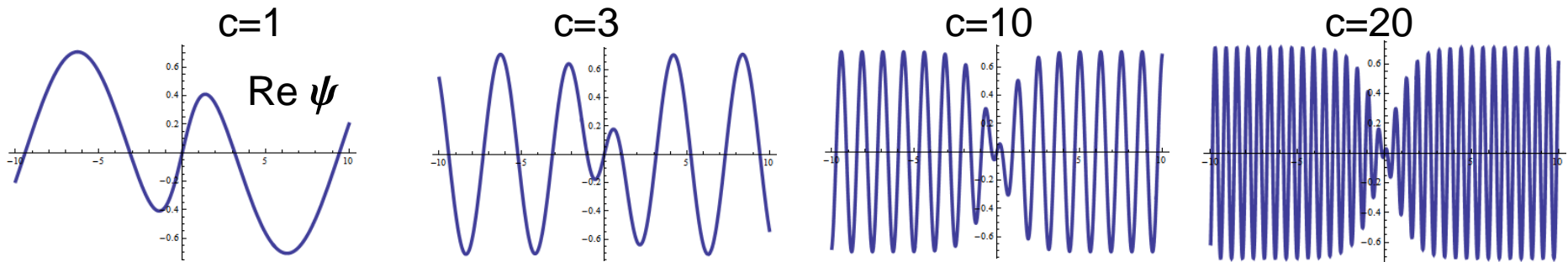

Focusing NSE: Breathers

Euler hydrodynamical equations

shallow water surface waves

KdV equation

deep water surface waves

NLS equation

Freak (rogue) wave: a single wave or a very short wave group with a significantly larger steepness than the surrounding waves – **Breather** solution of the NLS equation

$$\psi = \frac{\cos(\Omega t - 2ik) - \cosh(k) \cosh(px)}{\cos(\Omega t) - \cosh(k) \cosh(px)} e^{2it}; \quad \Omega = 2 \sinh(2k), \quad p = 2 \sinh k$$

Note: While for a bright soliton there is always a reference frame where the envelope $|\psi|$ is stationary, this is not so for breathers (“dynamical solitons”)

Limit of zero breathing period $k \rightarrow 0$:

Peregrine breather (1983)

$$\psi = \left[1 - \frac{4(1 + 4it)}{1 + 4x^2 + 16t^2} \right] e^{2it}$$

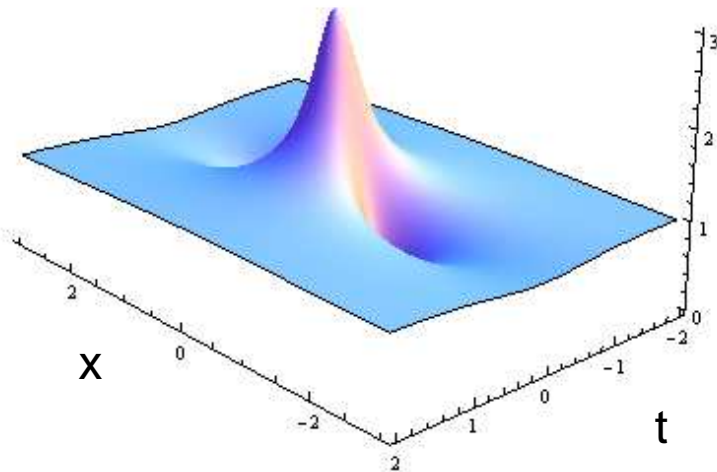

ZS-AKNS technique

The **ZS-AKNS scheme** is a generalisation of the Sturm-Liouville equation

Zakharov and Shabat - Ablowitz, Kaup, Newell, and Segur

Consider the 2x2 spectral linear problem

$$\begin{aligned}\psi_x^{(1)} &= -i\lambda\psi^{(1)} + q(x,t)\psi^{(2)} \\ \psi_x^{(2)} &= i\lambda\psi^{(2)} + p(x,t)\psi^{(1)}\end{aligned}$$

Note: If $p(x,t) = 0$ we recover the linear Sturm-Liouville equation:

$$(\psi^{(2)})_{xx} + (\lambda^2 + q)\psi^{(2)} = 0$$

Time evolution:

$$\begin{aligned}\psi_t^{(1)} &= A(x)\psi^{(1)} + B(x)\psi^{(2)} \\ \psi_t^{(2)} &= C(x)\psi^{(1)} + D(x)\psi^{(2)}\end{aligned}$$

$$(\psi_x^{(a)})_t = (\psi_t^{(a)})_x \Rightarrow \begin{cases} D = -A; & A_x = qC - pB \\ B_x + 2i\lambda B = q_t - 2Aq; \\ C_x - 2i\lambda C = p_t + 2Ar \end{cases}$$

Various solutions of this system yield different integrable PDE

We take $p = -\sigma q^*$
 $\sigma = \pm 1$

$$\begin{cases} A = -2i\lambda^2 + i\sigma q q^*; \\ B = 2q\lambda + iq_x; \\ C = -2\sigma q^* \lambda + i\sigma q_x^* \end{cases}$$

provided that $q(x,t)$ satisfies NLS:

$$iq_t + q_{xx} + 2\sigma|q|^2q = 0$$

$$\begin{aligned}\psi_t^{(1)} &= (-2i\lambda^2 + i\sigma|q|^2)\psi^{(1)} + (2q\lambda + iq_x)\psi^{(2)} \\ \psi_t^{(2)} &= (-2\sigma q^* \lambda + i\sigma q_x^*)\psi^{(1)} + (2i\lambda^2 - i\sigma|q|^2)\psi^{(2)}\end{aligned}$$

NLS direct scattering problem

● Focusing NLS: $\sigma=1$

Spectral problem:

$$q(x, t) \rightarrow 0 \text{ as } x \rightarrow \pm\infty \quad \begin{cases} \psi_x^{(1)} = -i\lambda\psi^{(1)} + q(x, t)\psi^{(2)} \\ \psi_x^{(2)} = i\lambda\psi^{(2)} - q^*(x, t)\psi^{(1)} \end{cases}$$

Complex conjugation: if $(\psi^{(1)}, \psi^{(2)})$ is an eigenvector, so is $(\psi^{(2)*}, -\psi^{(1)*})$

Asymptotically $(\psi^{(1)}, \psi^{(2)}) \rightarrow (k_1 e^{-i\lambda x}, k_2 e^{i\lambda x})$ as $x \rightarrow \pm\infty$ Jost solutions

Consider the set $\{(\psi_+^{(1)}, \psi_+^{(2)}), (\psi_+^{(2)*}, -\psi_+^{(1)*})\}$
 as a basis for solutions of the spectral problem



$$\begin{aligned} (\psi_+^{(1)}, \psi_+^{(2)}) &\rightarrow (e^{-i\lambda x}, 0) \text{ as } x \rightarrow +\infty \\ (\psi_+^{(2)*}, -\psi_+^{(1)*}) &\rightarrow (0, -e^{i\lambda x}) \text{ as } x \rightarrow +\infty \end{aligned}$$

Scattering problem

$$\begin{cases} \psi_-^{(1)} = a(\lambda)\psi_+^{(1)} + b(\lambda)\psi_+^{(2)*} \\ \psi_-^{(2)} = a(\lambda)\psi_+^{(2)} - b(x)\psi_+^{(1)*} \end{cases}$$

$$\begin{aligned} (\psi_-^{(1)}, \psi_-^{(2)}) &\rightarrow (e^{-i\lambda x}, 0) \text{ as } x \rightarrow -\infty \\ (\psi_-^{(2)*}, -\psi_-^{(1)*}) &\rightarrow (0, -e^{i\lambda x}) \text{ as } x \rightarrow -\infty \end{aligned}$$

Scattering data: $a(\lambda), b(\lambda)$

$$a(\lambda) \rightarrow 1, b(\lambda) \rightarrow 0 \text{ as } |\lambda| \rightarrow \infty$$

Note: Discrete spectrum is introduced as those values of λ , for which eigenvectors decay both for $x \rightarrow +\infty$ and for $x \rightarrow -\infty$ ("bound states") ➡ The discrete spectrum coincides with the zeros of the function $a(\lambda)$ in the upper half-plane.

NLS inverse scattering problem

- **Recall:** The inverse scattering problem – reconstruct the function $q(x, t)$ from the scattering data, $a(\lambda), b(\lambda)$

Consider representation with restrictions on the kernels of the Jost functions

$$\psi_+^{(1)} = e^{-i\lambda x} + \int_x^\infty K_1(x, y) e^{-i\lambda y} dy$$

$$\psi_+^{(2)} = \int_x^\infty K_2(x, y) e^{-i\lambda y} dy$$

$$K_1(x, y) = K_2(x, y) = 0 \text{ as } y < x$$

Spectral problem:

$$\begin{cases} \psi_x^{(1)} = -i\lambda\psi^{(1)} + q(x, t)\psi^{(2)} \\ \psi_x^{(2)} = i\lambda\psi^{(2)} - q^*(x, t)\psi^{(1)} \end{cases}$$

The boundary problem: $\left\{ \begin{array}{l} \frac{\partial K_1}{\partial x} + \frac{\partial K_1}{\partial y} = qK_2 \\ \frac{\partial K_2}{\partial x} - \frac{\partial K_2}{\partial y} = -q^*K_1 \end{array} \right.$

subject to $K_1(x, y) \rightarrow 0,$
 $K_2(x, y) \rightarrow 0$ as $y \rightarrow 0;$

$K_2(x, x) = \frac{1}{2}q^*$



if we can find $K_2(x, x)$ from our knowledge of the scattering data, we can reconstruct $q(x)$ from

$$q(x) = 2K_2^*(x, x)$$

NLS inverse scattering problem

Analogue of the Gelfand-Levitan-Marchenko equation:

$$K_2^*(x, y) \equiv K(x, y), \quad K(x, y) - F^*(x + y) + \int_x^\infty G(x, y, z)K(x, z)dz = 0$$

where

Discrete spectrum data

Reflection coefficient

$$G(x, y, z) = \int_x^\infty F(y + s)F^*(s + z)ds; \quad F(x) = -i \sum_{n=1}^N c_n e^{i\lambda_n x} + \frac{1}{2\pi} \int_{-\infty}^\infty \frac{b(\lambda)}{a(\lambda)} e^{i\lambda x} d\lambda$$

λ_n are the N zeros of $a(\lambda)$ in the upper half plane; $c_n = \frac{b(\lambda_n)}{a(\lambda_n)}$

- One bound state: a single zero of $a(\lambda)$ at $\lambda = \lambda_1$ and reflecteonless potential: $\frac{b(\lambda)}{a(\lambda)} = 0$

$$F(x) = -ic_1 e^{i\lambda_1 x}$$

$$\Rightarrow G(x, y, z) = \frac{i|c_1|^2}{\lambda_1 - \lambda_1^*} e^{i\lambda_1(x+y)} e^{-i\lambda_1^*(x+z)}$$

IS data equation:

$$K(x, y) - ic_1^* e^{-i\lambda_1^*(x+y)} - \frac{i|c_1|^2}{(\lambda_1 - \lambda_1^*)} \int_x^\infty e^{i\lambda_1(x+z)} e^{-i\lambda_1^*(x+y)} K(x, z)dz = 0$$

Ansatz: $K(x, y) = M(x)e^{-i\lambda_1^* y}$

$$\Rightarrow M(x) = \frac{ic_1^*(\lambda_1 - \lambda_1^*)^2 e^{-i\lambda_1^* x}}{(\lambda_1 - \lambda_1^*)^2 - |c_1|^2 e^{2i(\lambda_1 - \lambda_1^*)x}}$$

$$\lambda_1 = \alpha + i\beta$$

$$q(x) = 2M(x)e^{-i\lambda_1^* x} = ic_1^* e^{-2i\alpha x} \frac{2\beta}{|c_1|} \operatorname{sech} \left(2\beta x - \ln \frac{|c_1|}{2\beta} \right)$$

Time evolution of the scattering data

Time evolution:

$$\psi_t^{(1)} = (-2i\lambda^2 + iqq^*)\psi^{(1)} + (2\lambda q + iq_x)\psi^{(2)}$$

$$\psi_t^{(2)} = (-2\lambda q^* + iq_x^*)\psi^{(1)} + (2i\lambda^2 - iqq^*)\psi^{(2)}$$

Asymptotically $q \rightarrow 0$; $\{\psi_-^{(1)}, \psi_-^{(2)}\} \rightarrow \{a(\lambda, t)e^{-i\lambda x}, -b(\lambda, t)e^{i\lambda x}\}$ as $x \rightarrow +\infty$



$$a_t = -2i\lambda^2 a; \quad b_t = 2i\lambda^2 b$$

$$a(\lambda, t) = e^{-2i\lambda^2 t} a(\lambda, 0); \quad b(\lambda, t) = e^{2i\lambda^2 t} b(\lambda, 0)$$

Note: The zeros of $a(\lambda, t)$ (i.e. the discrete spectrum) are independent of time,

$$c_n(t) = e^{4i\lambda^2 t} c_n(0)$$

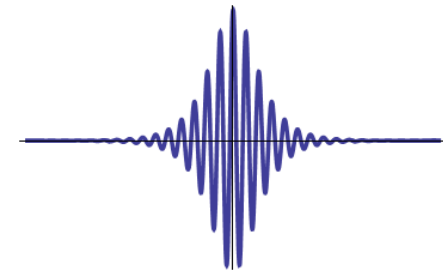

This yields the single bright NLS soliton:

$$q(x) = ic_1^*(0) e^{i(-2\alpha x + 4(\beta^2 - \alpha^2)t)} \frac{2\beta}{|c_1(0)|} \operatorname{sech} \left(2\beta(x + 4\alpha t) - \ln \frac{|c_1(0)|}{2\beta} \right)$$

Apropos: Boussinesq equation

Recall: The Lax pair for the KdV equation:

$$\mathbf{L}\psi \equiv (-\partial_{xx}^2 - u)\psi = \lambda\psi \quad \psi_t = \mathbf{A}\psi \equiv (-4\partial_{xxx}^3 - 6u\partial_x - 3u_x)\psi$$

Another example: The Lax pair for the Boussinesq-type equation

$$\mathbf{L}\psi \equiv (-\partial_{xxx}^3 + u\partial_x + v)\psi = \lambda\psi \quad \psi_t = \mathbf{A}\psi \equiv (\partial_{xx}^2 + \frac{2}{3}u)\psi$$

$$\frac{d}{dt}(-\partial^3 + u\partial + v) = [\mathbf{A}, \mathbf{L}] = (2v' - u'')\partial + v'' - \frac{2}{3}u''' - \frac{2}{3}uu'$$

$$\begin{cases} \dot{u} = 2v' - u''; \\ \dot{v} = v'' - \frac{2}{3}u''' - \frac{2}{3}uu' \end{cases}$$



$$u_{tt} = -\frac{1}{3}u_{xxx} - \frac{4}{3}(uu_x)_x$$

Boussinesq-type equations describe waves which can propagate both to the right, and to the left (“the two-way long-wave equations”).

$$u_{tt} - u_{xx} + 3(u^2)_{xx} + u_{xxxx} = 0$$

Travelling wave solution has the form $u \equiv u(\theta)$ where $\theta = x - vt$



$$u(x, t) = 2a^2 \operatorname{sech}^2(a(x - vt)); \quad v = \pm \sqrt{1 - 4a^2}$$

Fermi-Pasta-Ulam system

E Fermi, J Pasta, and S Ulam (1955): numerical study of the dynamics of an anharmonic chain of particles connected to their nearest neighbours by weakly nonlinear springs

MANIAC-1

(Mathematical Analyzer Numerical Integrator And Computer)

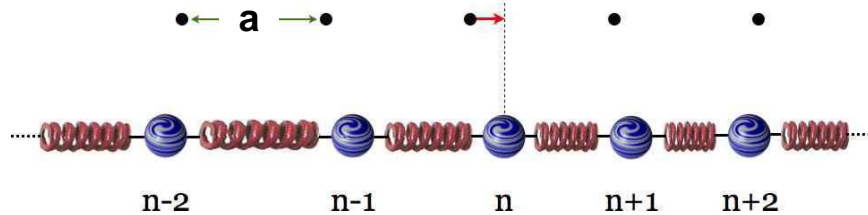
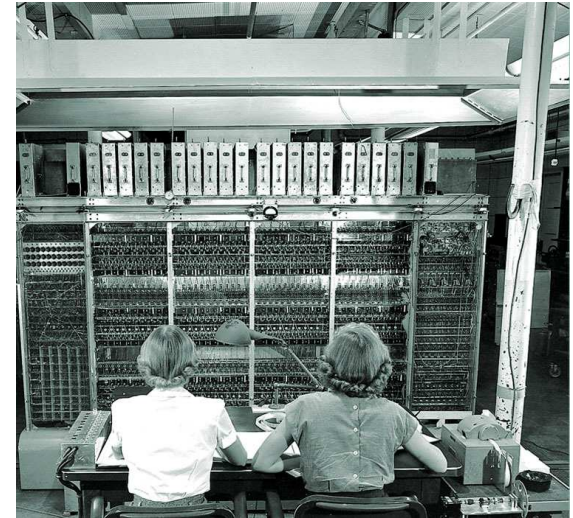

$$f(\Delta u) = k\Delta u + \alpha(\Delta u)^2$$

$$m\ddot{u}_n = f(u_{n+1} - u_n) - f(u_n - u_{n-1});$$

$$n = 1, 2 \dots N = 64$$

Weak non-linearity

u_n - displacement of the n -th particle from the equilibrium

$$m\ddot{u}_n = k(u_{n+1} - 2u_n + u_{n-1}) + \alpha [(u_{n+1} - u_n)^2 - (u_n - u_{n-1})^2]$$

A general solution of the linearized system ($\alpha=0$) is given by the expansion in the normal modes:

$$u_n^k(t) = A_k \sin\left(\frac{k\pi na}{N+1}\right) \cos(\omega_k t + \delta_k)$$

$$\omega_k = 2\sqrt{\frac{k}{m}} \sin\left(\frac{k\pi a}{2(N+1)}\right)$$

STUDIES OF NON LINEAR PROBLEMS

E. FERMI, J. PASTA, and S. ULAM
Document LA-1940 (May 1955).

A one-dimensional dynamical system of 64 particles with forces between neighbors containing nonlinear terms has been studied on the Los Alamos computer MANIAC I. The nonlinear terms considered are quadratic, cubic, and broken linear types. The results are analyzed into Fourier components and plotted as a function of time.

The results show very little, if any, tendency toward equipartition of energy among the degrees of freedom.

$$\ddot{x}_i = (x_{i+1} + x_{i-1} - 2x_i) + \alpha [(x_{i+1} - x_i)^2 - (x_i - x_{i-1})^2]$$
$$(i = 1, 2, \dots, 64),$$

Fermi-Pasta-Ulam... + Mary Tsingou

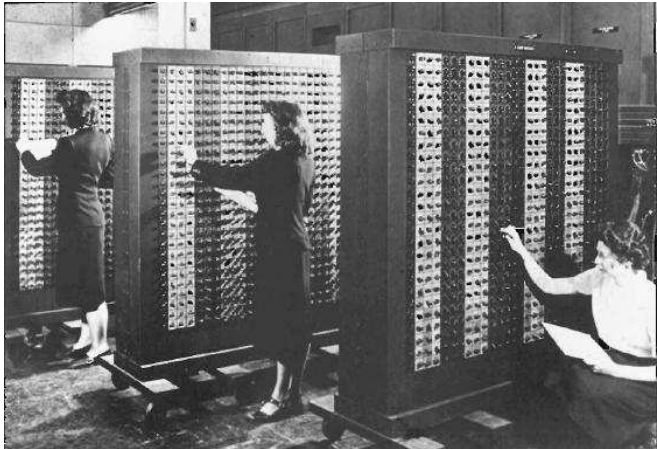

All numerical simulations of the Fermi-Pasta-Ulam problem were performed by *Mary Tsingou*



Note: There is no energy transfer between the modes in the linear approximation. In the nonlinear chain ($\alpha \neq 0$) modes become coupled. It was expected that if all the initial energy was put into a few lowest modes, the nonlinear coupling would yield equal distribution of the energy among the normal modes.

However: If the energy was initially in the mode of lowest frequency, it returned almost entirely to that mode after interaction with a few other low frequency modes

What was observed?

982

266. - Studies of non Linear Problems

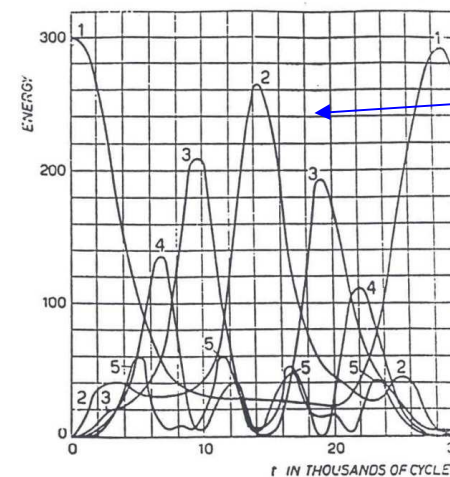

Recurrences

Fig. 1. - The quantity plotted is the energy (kinetic plus potential in each of the first five modes). The units for energy are arbitrary. $N = 32$; $\alpha = 1/4$; $\beta t^2 = 1/8$. The initial form of the string was a single sine wave. The higher modes never exceeded in energy 20 of our units. About 30,000 computation cycles were calculated.

From Fermi-Pasta-Ulam to Boussinesq equation

- Continuum approximation (Zabusky and Kruskal (1965)):

$$u_n(t) = u(x_n, t) = u(na, t); \quad u_{n\pm 1}(t) = u(x_n \pm a, t)$$

- Gradient expansion:

$$u_{n\pm 1}(t) \approx u(x_n, t) \pm au'(x_n, t) + \frac{a^2}{2}u''(x_n, t) \pm \frac{a^3}{3!}u'''(x_n, t) + \frac{a^4}{4!}u''''(x_n, t) + \dots$$

FPU:

$$m\ddot{u}_n = k(u_{n+1} - 2u_n + u_{n-1}) + \alpha [(u_{n+1} - u_n)^2 - (u_n - u_{n-1})^2]$$

Boussinesq:

$$u_{tt} - c^2u_{xx} = \varepsilon c^2(u_x u_{xx} + \delta^2 u_{xxxx})$$

$$c^2 = \frac{ka^2}{m}; \quad \varepsilon = \frac{2\alpha a}{k}; \quad \delta^2 = \frac{a^2}{12\varepsilon}$$

Note: the leading order nonlinear and dispersive contributions in the r.h.s. are balanced at the same order of ε

J. Boussinesq originally derived a system of two first-order (in time) equations for weakly nonlinear surface waves in shallow water (1881)

$$\begin{cases} \eta_t + u_x + (\eta u)_x = 0 \\ u_t + \eta_x + uu_x - u_{xxt} = 0 \end{cases}$$

u is the horizontal velocity

η is the free surface elevation

From Boussinesq equation to KdV

$$u_{tt} - c^2 u_{xx} = \varepsilon c^2 (u_x u_{xx} + \delta^2 u_{xxxx})$$

- Asymptotic multiple-scale expansion: $u(x, t) = f(\theta, T) + \varepsilon v(x, t)$
 $\theta = x - ct, \quad T = \varepsilon t$



$$v_{tt} - c^2 v_{xx} = 2c f_{T\theta} + c^2 f_{\theta} f_{\theta\theta} + c^2 \delta^2 f_{\theta\theta\theta\theta} + \dots$$

Note: The function $v(x, t)$ grows linearly in $\bar{\theta} = x + ct$ unless the r.h.s is not zero:

$$2c f_{T\theta} + c^2 f_{\theta} f_{\theta\theta} + c^2 \delta^2 f_{\theta\theta\theta\theta} = 0$$

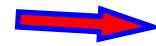

KdV:

$$q_{\tau} + 6qq_{\theta} + \delta^2 q_{\theta\theta\theta} = 0$$

- Change of variables: $q = \frac{f_{\theta}}{6}; \quad \tau = \frac{cT}{2}$

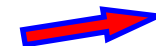

In 1965 Kruskal and Zabusky numerically studied the dynamics of the KdV equation with sinusoidal initial conditions (for small $\delta = 0.022$ with periodic boundary conditions)

- The appearing solitary waves interact with each other elastically
- They have called the waves **solitons** since they behave like particles
- Explanation of the FPU recurrence as property of the system of solitons moving with different speed. Since the system studied was of finite length, solitons eventually reassembled in the (x, t) plane and approximately recreated the initial configuration

The Frenkel-Kontorova model

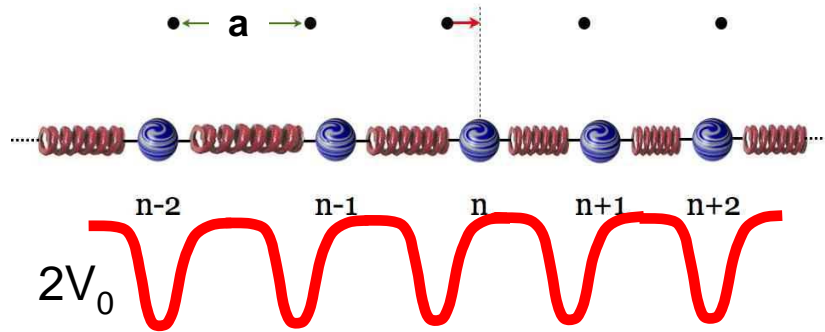

The original FK model (1938) was proposed to describe dislocations in metals. The atoms are treated as a one-dimensional chain subjected to an external periodic potential produced by the surrounding atoms.

$$L = T - V = \sum_n \frac{m\dot{u}_n^2}{2} - \frac{\alpha}{2} \sum_n (u_{n+1} - u_n)^2 - V_0 \sum_n \left(1 - \cos \frac{2\pi u_n}{a} \right)$$

• **Rescaling I:** $u_n \rightarrow \frac{2\pi u_n}{a}; \quad t \rightarrow \frac{2\pi}{a} \sqrt{\frac{V_0}{m}} t; \quad \alpha \rightarrow \alpha \frac{(a/2\pi)^2}{V_0}$



$$\ddot{u}_n - \alpha(u_{n+1} - 2u_n + u_{n-1}) = -\sin u_n$$

• **Gradient expansion:** $u_{tt} - \alpha a^2 u_{xx} = -\sin u$

• **Rescaling II:** $x \rightarrow \frac{x}{a\sqrt{\alpha}}$ \rightarrow $u_{tt} - u_{xx} + \sin u = 0$

This is the sine-Gordon equation

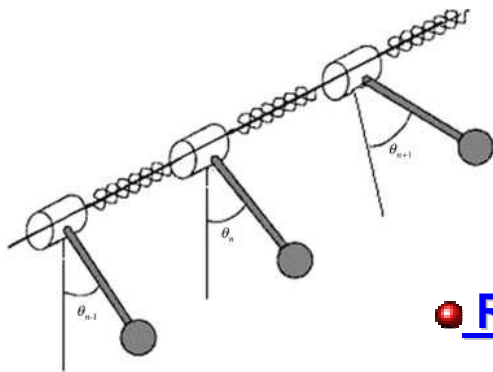

Sine-Gordon model: Josephson junctions

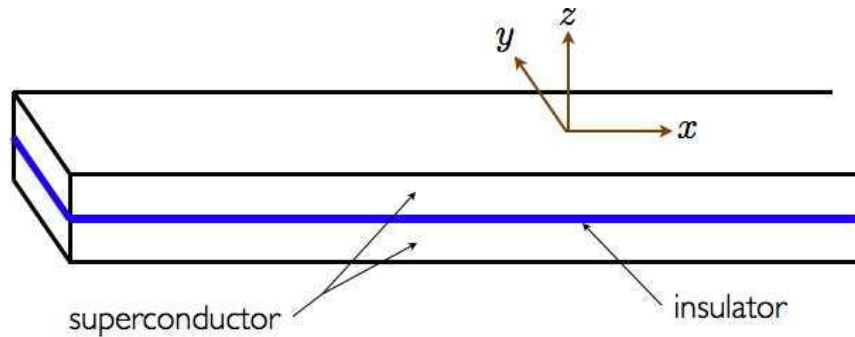

Superconducting transmission line

- Capacitance C per unit length
- Inductance \mathcal{L} per unit length
- Critical current I_0 per unit length
- Josephson phase $\phi = \phi_2 - \phi_1$
- Voltage V

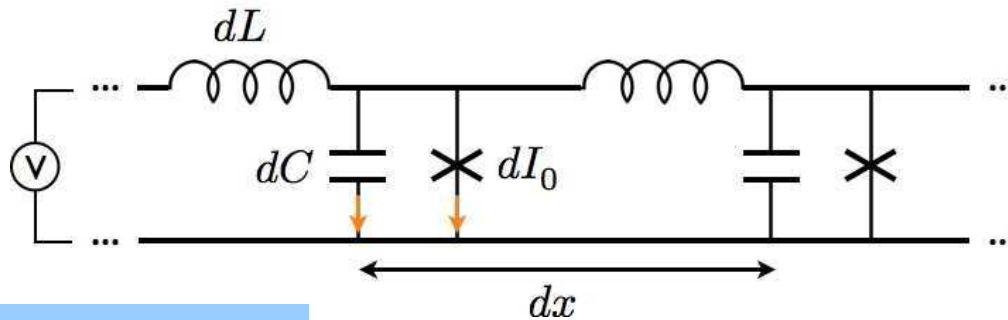

shunt current

$$\frac{\partial V}{\partial x} = -\mathcal{L} \frac{\partial I}{\partial t} \quad \leftarrow \quad \frac{\partial \phi}{\partial t} = \frac{2eV}{\hbar}$$

$$\frac{\partial I}{\partial x} = -C \frac{\partial V}{\partial t} - I_0 \sin \phi$$

$$\frac{\partial \phi}{\partial x} = -\frac{2e\mathcal{L}}{\hbar} I$$

Swihart velocity:

$$c = 1/\sqrt{\mathcal{L}C}$$

$$\frac{1}{c^2} \frac{\partial^2 \phi}{\partial t^2} - \frac{\partial^2 \phi}{\partial x^2} + \frac{1}{\lambda^2} \sin \phi = 0$$

sine-Gordon equation!

Josephson length

$$\lambda = \sqrt{\hbar/2e\mathcal{L}I_0}$$

Sine-Gordon model: scalar field theory

$$L = \frac{1}{2} \partial_\mu \phi \partial^\mu \phi - U(\phi); \quad U(\phi) = 1 - \cos \phi$$

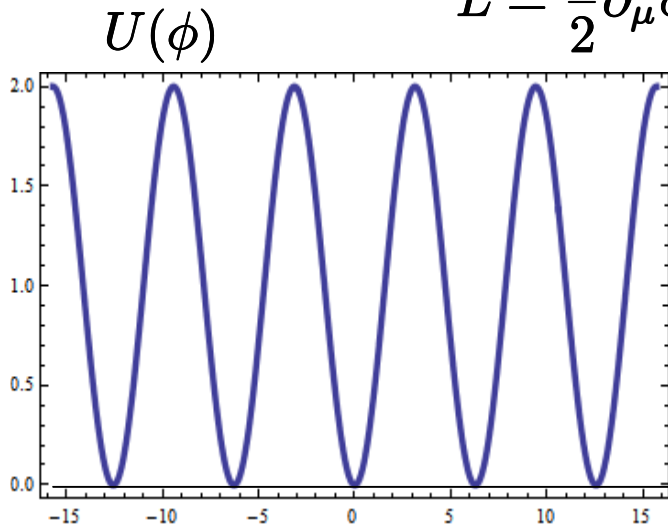

Note: The model is Lorentz-invariant

Field equation:

Symmetry:

$$\phi_{tt} - \phi_{xx} + \sin \phi = 0$$

$$\phi \rightarrow \phi \pm 2\pi n, \quad n \in \mathbb{Z}$$

Non-trivial static solutions: the function $\phi(x)$ interpolates between $\phi(-\infty) = 0$ and $\phi(+\infty) = 2\pi$

• **Integration:** $\phi_{xx} = \sin \phi$ | X integrating factor $\frac{d\phi}{dx}$

$$\frac{1}{2} \left(\frac{d\phi}{dx} \right)^2 = -\cos \phi + C$$

Boundary condition: $\phi_x \rightarrow 0$ as $x \rightarrow \pm\infty$ $\Rightarrow C = 1$

It looks like an equation of motion of a “particle” in the effective potential

• **Separating the variables:**

$$x - x_0 = \pm \int \frac{d\phi}{\sqrt{2(1 - \cos \phi)}} = \pm \int \frac{d\phi}{2 \sin(\phi/2)} = \int d(\ln \tan \frac{\phi}{4})$$

• **Kink solution:**

$$\phi = \pm 4 \arctan \exp(x - x_0)$$

Busted kink: $x \rightarrow \frac{x - vt}{\sqrt{1 - v^2}}$

Sine-Gordon model: scalar field theory

- Note:**
- Unlike KdV solitary wave the function $\phi(x)$ does not go to 0 as $x \rightarrow \pm\infty$
 - The amplitude of the SG soliton is independent of its velocity
 - SG soliton is **topological**
 - The SG model is integrable
 - The SG model is relativistic-invariant

For small $\phi(x)$ $1 - \cos \phi \approx \frac{\phi^2}{2} + \frac{\phi^4}{4} + \dots$

ϕ^4 model

$$L = \frac{1}{2} \partial_\mu \phi \partial^\mu \phi - (\phi^2 - 1)^2$$

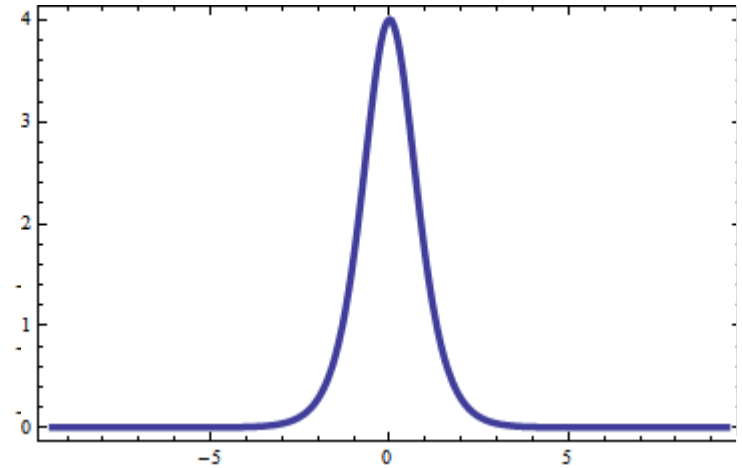

Kink solution: $\phi_{K\bar{K}} = \pm 4 \arctan(e^{-x+x_0})$

Energy density: $\mathcal{E} = \frac{4}{\cosh^2(x - x_0)}$



Mass of the kink: $M = \int \mathcal{E} dx = 8$

Topological charge: $Q = \frac{1}{2\pi} \int_{-\infty}^{\infty} dx \frac{\partial \phi}{\partial x}$ - n-fold cover of $[0, 2\pi]$

Topological current: $J_\mu = \frac{1}{2\pi} \varepsilon_{\mu\nu} \partial^\nu \phi, \quad \partial^\mu J_\mu \equiv 0$

Note: This is not a Noether current!

Sine-Gordon model is integrable!

Bäcklund transformation: if we have a solution of an integrable system, even a trivial one, there is a transformation which transforms it into a new non-trivial solution.

• **Example I:** Laplace equation in 2d $\Delta u(x, y) = (\partial_x^2 + \partial_y^2)u = 0$

Let us take another equation for a new function $v(x, y)$:

$$\Delta v(x, y) = (\partial_x^2 + \partial_y^2)v = 0$$

Note: the functions $u(x, t)$ and $v(x, t)$ are not independent:

$$\partial_x u = \partial_y v; \quad \partial_y u = -\partial_x v$$

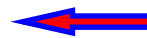

Bäcklund transformation

Indeed $\partial_x(\partial_x u) = \partial_x(\partial_y v)$, $\partial_y(\partial_y u) = -\partial_y(\partial_x v)$, so sum of these two equations yields the original Laplace equation.

Now we take the trivial solution $v(x, y) = xy$ and plug it into the Bäcklund transformation:

$$u_x = x; \quad u_y = -y \quad \text{i.e.} \quad u = \frac{1}{2} (x^2 - y^2)$$

Bäcklund transformation for the sine-Gordon model

- Light cone coordinates:

$$x_{\pm} = \frac{1}{2}(x \pm t) \quad \partial_x = \frac{1}{2}\partial_+ + \frac{1}{2}\partial_-; \quad \partial_t = \frac{1}{2}\partial_+ - \frac{1}{2}\partial_-$$

↓

$$\partial_t^2 - \partial_x^2 = -\partial_- \partial_+ \quad \text{Then the SG equation becomes } \partial_- \partial_+ \phi = \sin \phi$$

- Consider the pair of equations:

SG Bäcklund transformation

$$\partial_+ \psi = \partial_+ \phi - 2\lambda \sin\left(\frac{\phi + \psi}{2}\right), \quad \partial_- \psi = -\partial_- \phi + \frac{2}{\lambda} \sin\left(\frac{\phi - \psi}{2}\right)$$

↓

$$\partial_- \partial_+ \psi = \partial_- \partial_+ \phi - 2 \cos\left(\frac{\phi + \psi}{2}\right) \sin\left(\frac{\phi - \psi}{2}\right) = \partial_- \partial_+ \phi + \sin \phi - \sin \psi$$

If $\partial_- \partial_+ \phi = \sin \phi$, then $\partial_- \partial_+ \psi = \sin \psi$

- Start with the trivial vacuum solution: $\phi=0$

Homework: Prove it!

$$\partial_+ \psi = -2\lambda \sin(\psi/2); \quad \partial_- \psi = -2\lambda^{-1} \sin(\psi/2) \quad \Rightarrow \quad \psi = 4 \arctan(e^{-\lambda x_+ - \lambda^{-1} x_-})$$

- Back to original coordinates: $\lambda x_+ + \lambda^{-1} x_- = \pm \frac{x - vt}{\sqrt{1 - v^2}} \quad \Leftrightarrow \quad v = \frac{1 - \lambda^2}{1 + \lambda^2}$

Kink solution:

$$\phi_{K\bar{K}} = \pm 4 \arctan\left(e^{\pm \frac{x - vt}{\sqrt{1 - v^2}}}\right)$$

Bäcklund transformation for the sine-Gordon model

● SG two-soliton solution:

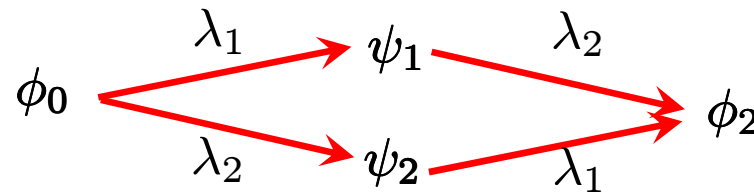

Eliminating the derivatives in the SG Bäcklund transformation, we obtain ($\phi_0=0$)

$$\tan\left(\frac{\phi_2}{4}\right) = \left(\frac{\lambda_1 + \lambda_2}{\lambda_1 - \lambda_2}\right) \tan\left(\frac{\psi_2 - \psi_1}{2}\right)$$

Recall:

$$\psi_{1,2} = 4 \arctan e^{\theta_{1,2}} \quad \theta_{1,2} = \frac{1}{2} (\lambda_i x + \lambda_i^{-1} t + C_i) \quad \downarrow$$

2 one-soliton solutions

$$\phi_2 = 4 \arctan\left(\frac{\lambda_1 + \lambda_2}{\lambda_1 - \lambda_2}\right) \frac{e^{\theta_1} - e^{\theta_2}}{1 + e^{\theta_1 + \theta_2}}$$

two-soliton solution

● Consider asymptotic: $\theta_2 \gg 1 \rightarrow \frac{e^{\theta_1} - e^{\theta_2}}{1 + e^{\theta_1 + \theta_2}} \rightarrow \frac{e^{\theta_1}/e^{\theta_2} - 1}{e^{-\theta_2} + e^{\theta_1}} \sim -e^{-\theta_1}$

● The symmetric 2-kink solution (head-on collision, identical velocities):

$$\lambda_2 = -\frac{1}{\lambda_1}; \quad v = \frac{1 - \lambda_1^2}{1 + \lambda_1^2}, \quad \lambda_1 > 0$$

$$\phi_2 = 4 \arctan \left[\frac{v \sinh \frac{x}{\sqrt{1-v^2}}}{\cosh \frac{vt}{\sqrt{1-v^2}}} \right]$$

Topological charge: $Q = \frac{1}{2\pi} \int_{-\infty}^{\infty} dx \frac{\partial \phi_2}{\partial x} = 2$

sine-Gordon model: 2-soliton interactions

● **KK-collison** $v=0.8$ $\phi_2 = 4 \arctan \left[\frac{v \sinh \frac{x}{\sqrt{1-v^2}}}{\cosh \frac{vt}{\sqrt{1-v^2}}} \right]$

Asymptotic: $\theta \rightarrow \pm\infty$
 The phase shift: $\delta = 2\sqrt{v^2 - 1} \ln v$

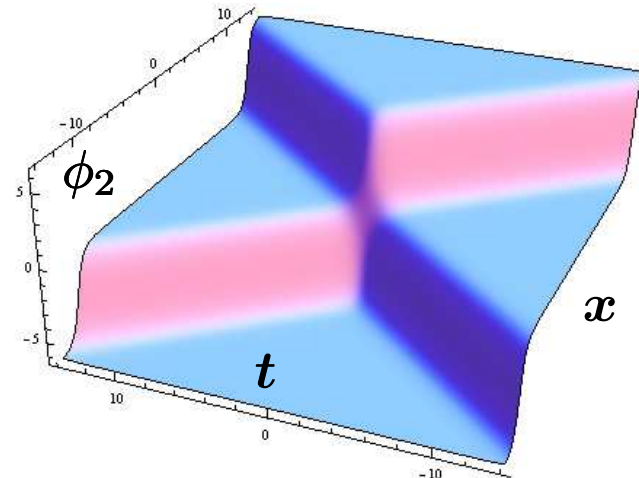

● **KK-bar-collison** $v=0.8$ $\lambda_2 = \frac{1}{\lambda_1}; v = \frac{1 - \lambda_1^2}{1 + \lambda_1^2}, \lambda_1 > 0$
 $\phi_2 = 4 \arctan \left[\frac{\sinh \frac{vt}{\sqrt{1-v^2}}}{v \cosh \frac{x}{\sqrt{1-v^2}}} \right]$

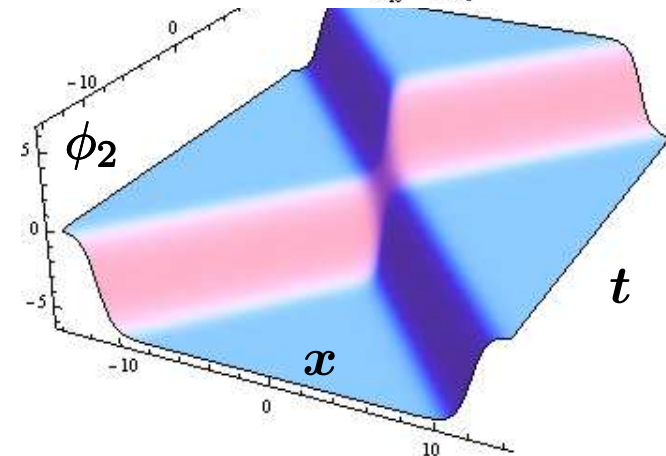

● **Breather:** $v = \frac{i\omega}{\sqrt{1 - \omega^2}}$ $\phi_2 = 4 \arctan \left[\frac{\sqrt{1 - \omega^2}}{\omega} \frac{\sin \omega t}{\cosh \sqrt{1 - \omega^2} x} \right]$

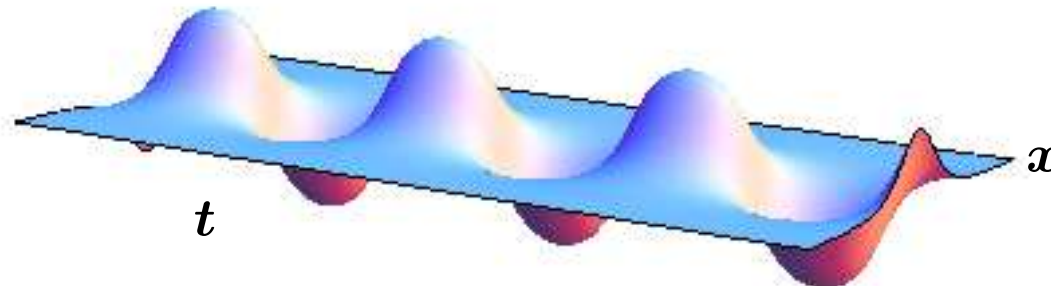

sine-Gordon model: Lax pair formulation

Recall: Lax pair is given by two linear equations

$$\psi_x = L\psi; \quad \psi_t = A\psi \quad \psi = \begin{pmatrix} \psi_{11} & \psi_{12} \\ \psi_{21} & \psi_{22} \end{pmatrix}$$

$$\begin{cases} \psi_{xt} = L_t\psi + L\psi_t; \\ \psi_{tx} = A_x\psi + A\psi_x. \end{cases}$$

$$\underline{L_t\psi + LA\psi = A_x\psi + AL\psi;}$$

$$L_t - A_x = [A, L]$$

Zero curvature condition

• sine-Gordon:

$$\left\{ \begin{aligned} L &= i\lambda \begin{pmatrix} 1 & 0 \\ 0 & -1 \end{pmatrix} + \frac{i}{2} \begin{pmatrix} 0 & u_x \\ u_x & 0 \end{pmatrix} = i\lambda \cdot \sigma_3 + \frac{i}{2} u_x \cdot \sigma_1; \quad \lambda \in \mathbb{C} \\ A &= \frac{\cos u}{4i\lambda} \begin{pmatrix} 1 & 0 \\ 0 & -1 \end{pmatrix} + \frac{1}{4i\lambda} \begin{pmatrix} 0 & -i \\ i & 0 \end{pmatrix} = \frac{\cos u}{4i\lambda} \cdot \sigma_3 + \frac{1}{4i\lambda} \cdot \sigma_2 \end{aligned} \right.$$



$$L_t = \frac{i u_{tx}}{2} \cdot \sigma_1; \quad A_x = -\frac{1}{4i\lambda} u_x \sin u \cdot \sigma_3 + \frac{1}{4i\lambda} u_x \cdot \sigma_2$$



$$[A, L] = \frac{i}{4\lambda} \cdot \sigma_2 - \frac{i}{4\lambda} \cdot \sigma_3 + \frac{i}{2} \sin u \cdot \sigma_1$$

in 0th order in λ

$$\frac{i u_{tx}}{2} \cdot \sigma_1 = \frac{i}{2} \sin u \cdot \sigma_1$$

sine-Gordon equation is recovered!

sine-Gordon \leftrightarrow massive Thirring model

$$S = \int d^2x \left[\frac{1}{2} \partial_\mu \phi \partial^\mu \phi - \frac{\alpha}{\beta^2} (1 - \cos \beta \phi) \right]$$

sine-Gordon model

Thirring model

$$S = \int d^2x \left[i\bar{\psi} \gamma_\mu \partial^\mu \psi + m\bar{\psi} \psi - \frac{g}{2} (\bar{\psi} \gamma_\mu \psi) (\bar{\psi} \gamma^\mu \psi) \right]$$

$$\gamma_0 = \sigma_1, \quad \gamma_1 = -i\sigma_2, \quad \gamma_5 = \gamma_0 \gamma_1 = \sigma_3$$

Invariances: $\phi \rightarrow \phi' = \phi + \frac{2\pi n}{\beta}; \quad \psi \rightarrow \psi' = e^{i\alpha_V} \psi; \quad \psi \rightarrow \psi' = e^{i\gamma_5 \alpha_A} \psi$

Bosonization: $m\bar{\psi} \frac{1 \mp \gamma_5}{2} \psi = -\frac{\alpha}{\beta^2} e^{\pm i\phi} \quad \frac{\beta^2}{4\pi} = \frac{1}{1+g/\pi}$

Meson states \rightarrow fermion-anti fermion bound states

(S.Coleman, 1975)

Soliton \rightarrow fundamental fermion

The topological current of the sine-Gordon model $J_\mu = \frac{1}{2\pi} \epsilon_{\mu\nu} \partial^\nu \phi$

coincides with the Noether current of the massive Thirring model $j_\mu = i\bar{\psi} \gamma_\mu \partial^\mu \psi$

Solitons vs. Solitary Waves

<u>Equation</u>		<u>Solution</u>
S-G: $\ddot{\phi} - \phi'' + \sin \phi = 0$	YES	$\phi_{K\bar{K}} = \pm 4 \arctan (e^{-x+x_0})$
$\lambda\phi^4$: $\ddot{\phi} - \phi'' - \phi + \phi^3 = 0$	NO!	$\phi_{K\bar{K}} = \pm a \tanh \left(\frac{m(x-x_0)}{\sqrt{2}} \right)$

How do we know if it is integrable or it is a non-integrable?

Historically, combination of “**experimental mathematics**” (ϕ^4) and known analytic solutions (S-G), then inverse scattering transform, group theoretic structure (Kac-Moody Algebras), Painlevé test.

Does any part of “hierarchy” of solitons in integrable theories (S-G breather) exist in non-intergrable theories?

Topology primer: maps and windings

Kinks in 2d:

Space: $+\infty$ ●
 $-\infty$ ●

Vacuum: $+1$ ●
 -1 ●

Maps:

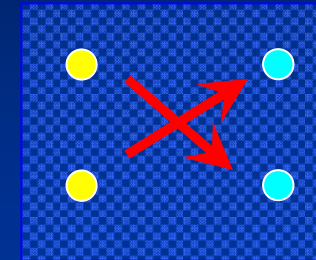
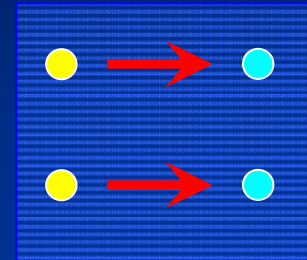

Topological charge: $Q = \frac{1}{2} \int_{-\infty}^{\infty} dx \frac{\partial \phi}{\partial x} = \phi(\infty) - \phi(-\infty)$

Circles: $S^1 \rightarrow S^1$

Space:

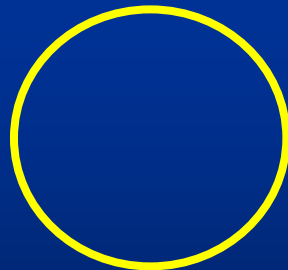

Vacuum:

$$\phi^\alpha = (\sin \varphi; \cos \varphi)$$

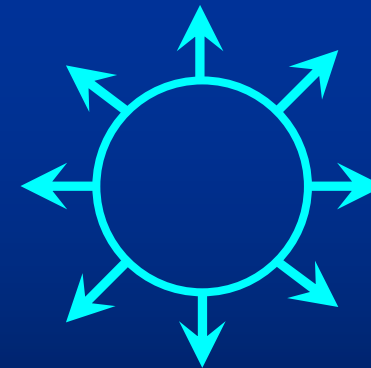

Maps:



Circles: $S^1 \rightarrow S^1$

Topological charge:

$$Q = \frac{1}{2\pi} \int_0^{2\pi} d\varphi \varepsilon_{\alpha\beta} \frac{d\phi^\alpha}{d\varphi} \phi^\beta$$

$Q=0:$

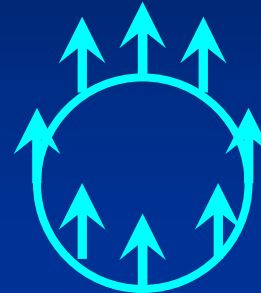

Vacuum:

$$\phi^\alpha = (0, 1)$$

$Q=1:$

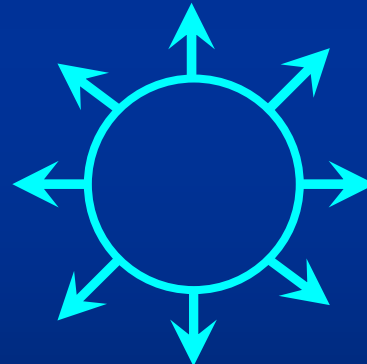
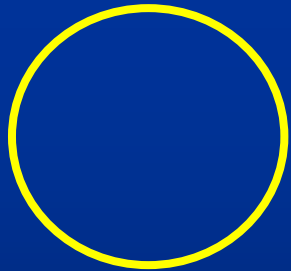

$$\phi^\alpha = (\sin \varphi; \cos \varphi)$$

$Q=2:$

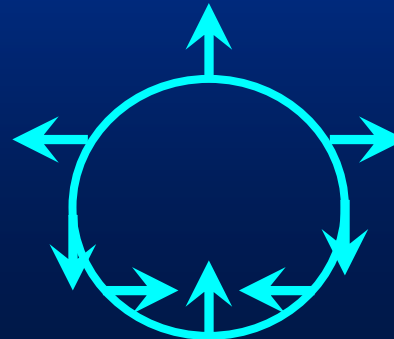

$$\phi^\alpha = (\sin 2\varphi; \cos 2\varphi)$$

Scaling arguments: Derrick's theorem

Consider a model with scalar field in d-dim

$$E[\phi] = \int d^d x [\partial_\mu \phi \partial^\mu \phi + U(\phi)] = E_2 + E_0$$

Scale transformation: $\vec{x} \rightarrow \vec{y} = \lambda \vec{x}$; $\partial_\mu \phi(\vec{x}) = \frac{\partial \phi(\vec{x})}{\partial x_\mu} \rightarrow \lambda \frac{\partial \phi(\lambda \vec{x})}{\partial (\lambda x_\mu)} = \lambda \frac{\partial \phi(\vec{y})}{\partial y_\mu}$

$$d^d x \rightarrow d^d(\lambda x) \lambda^{-d} = \lambda^{-d} d^d y \quad \longrightarrow \quad E[\phi] \rightarrow \lambda^{2-d} E_2 + \lambda^{-d} E_0$$

Each term is positive. If there is a stationary point of $E(\lambda)$?

$$\frac{dE[\lambda\phi]}{d\lambda} = (2-d)\lambda^{1-d} E_2 - d\lambda^{-d-1} E_0$$

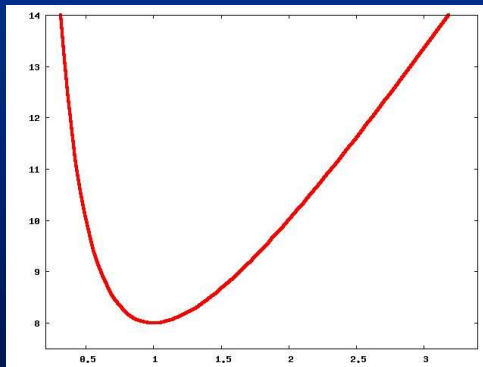

d=1

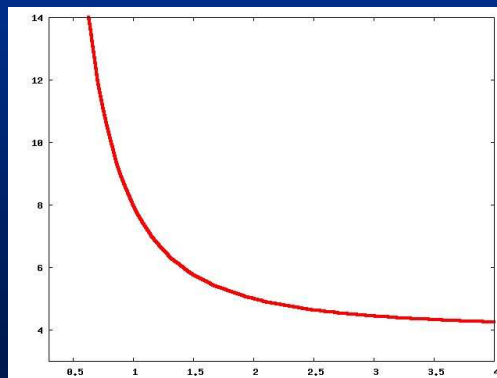

d=2

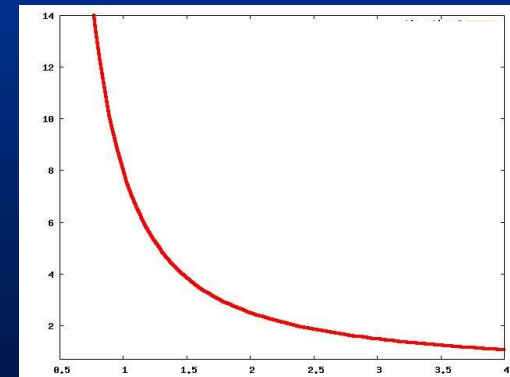

d=3

For a simple model $E[\phi] = \int d^d x [\partial_\mu \phi \partial^\mu \phi + U(\phi)] = E_2 + E_0$

nontrivial solutions ($E_2 \neq 0, E_0 \neq 0$) are possible only in $d=1$

There are 3 possibilities to evade Derrick's theorem:

- **d=2:** take $E_0 = 0$, then the model is scale-invariant
- Extend the model including higher derivatives in ϕ (Skyrme model in $d=3$, baby Skyrme model in $d=2$, Faddeev-Skyrme model in $d=3$)
- Extend the model including gauge fields (monopoles in $d=3$, instantons in Euclidean space $d=4$)

$$\vec{x} \rightarrow \lambda \vec{x} = \vec{y}; \quad A_\mu(\vec{x}) \rightarrow \lambda A_\mu(\vec{y}); \quad D_\mu \phi(\vec{x}) \rightarrow \lambda D_\mu \phi(\vec{y}); \quad F_{\mu\nu}(\vec{x}) \rightarrow \lambda^2 F_{\mu\nu}(\vec{y})$$

$$E[\phi] = \int d^d x [|F_{\mu\nu}|^2 + |D_\mu \phi|^2 + U(\phi)] = E_4 + E_2 + E_0$$

$$E[\phi] \rightarrow \lambda^{4-d} E_4 + \lambda^{2-d} E_2 + \lambda^{-d} E_0$$

If we restrict ourselves to the models with quadratic terms in derivatives, there are possibilities:

- **d=1**: there are soliton solutions in the models with gauge and scalar fields or in pure scalar models with a potential $U(\phi)$ (*Kinks*).
- **d=2**: there are soliton solutions in the models with gauge and scalar fields (*vortices*) or in pure scalar models without potential $U(\phi)$ (*Lumps*).
- **d=3**: there are soliton solutions in the models with gauge and scalar fields (*monopoles*)
- **d=4**: there are soliton solutions in the models with gauge field only (*instantons*)
- **d>4**: there are no soliton solutions, higher derivatives are necessary.

Alternative: one can consider time-dependent stationary configurations!