

Experimental exploration



*of the QCD phase
diagram*

ROGACHEVSKY Oleg
for MPD collaboration

*International Mini-Workshop
on Simulations of HIC for NICA energies
April 12 2017 Dubna*

QCD Phase diagram



QCD Phase diagram

NICA energy scan: MPD $4 < \sqrt{s} < 11$ GeV

BM@N $1 < E_{\text{kin}} < 4.5$ GeV

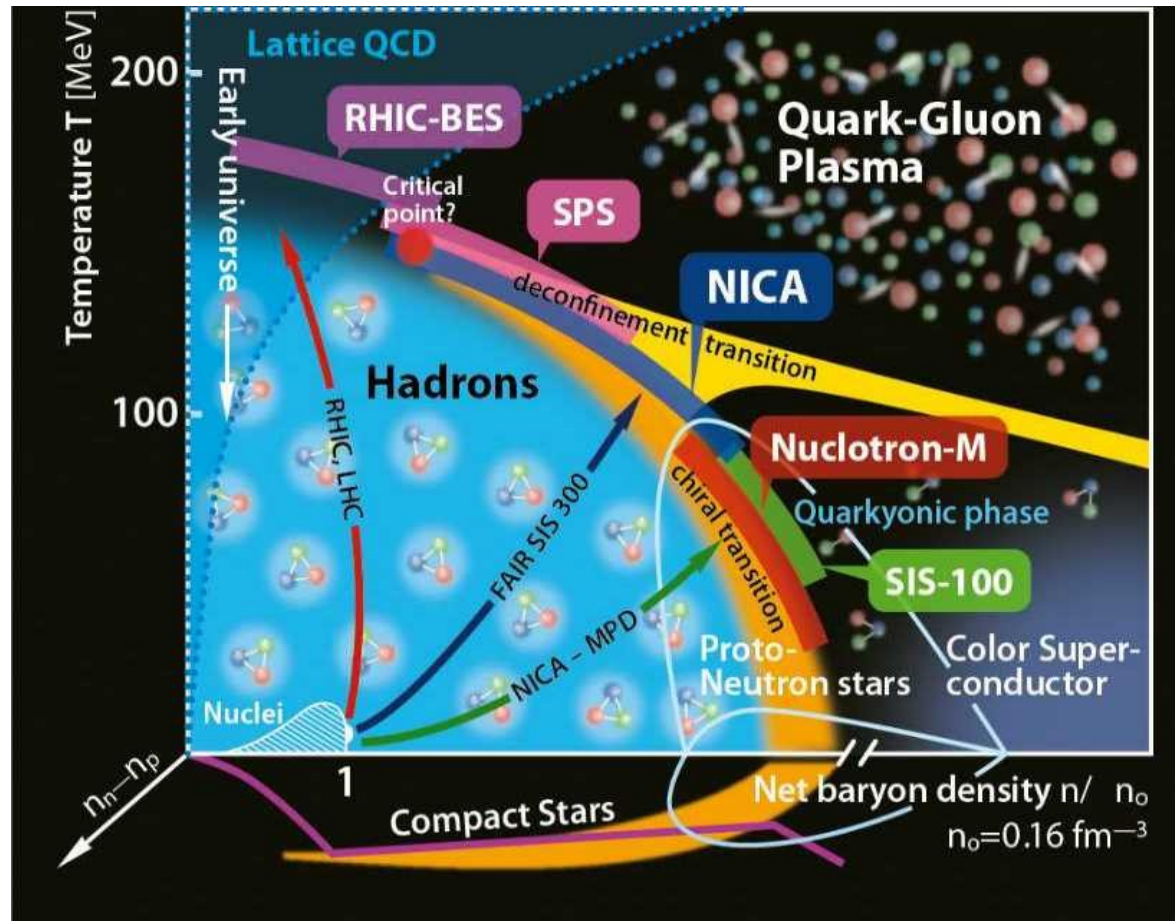

Accelerators for Relativistic Nuclear Physics

Accelerator	Place	Ion periods	Energy	Projectiles
Synchro-Phasatron	JINR Dubna	1971 - 1985	3.6 AGeV	d, He, C
Bevalac	LBNL Berkeley	1974 - 1984	< 2AGeV	C,Ca,Nb, Ni,Au,...
AGS	BNL, Brookhaven	1986 - 1994	14,5/11,5 AGeV	Si, Au
SPS	CERN, Geneva	1986 - 2002	200/158 AGeV	O,S,In,Pb
SIS 18	GSI,Darmstadt	1992 - today	2 AGeV	Kr,Au
Nuclotron	JINR Dubna	1993 - today	< 4.5 AGeV	p, d, He,C,Li, Mg, Kr
RHIC	BNL, Brookhaven	2000 - today	$\sqrt{s_{NN}} = 200 \text{ GeV}$	Cu, Au
LHC	CERN, Geneva	2010	$\sqrt{s_{NN}} = 5.5 \text{ TeV}$	Pb
NICA	JINR Dubna	2019	$\sqrt{s_{NN}} = 4 - 11 \text{ GeV}$	p - Au
SIS 100	GSI,Darmstadt	2025	2 – 11 AGeV	Au

Relativistic nuclear physics in JINR LHE

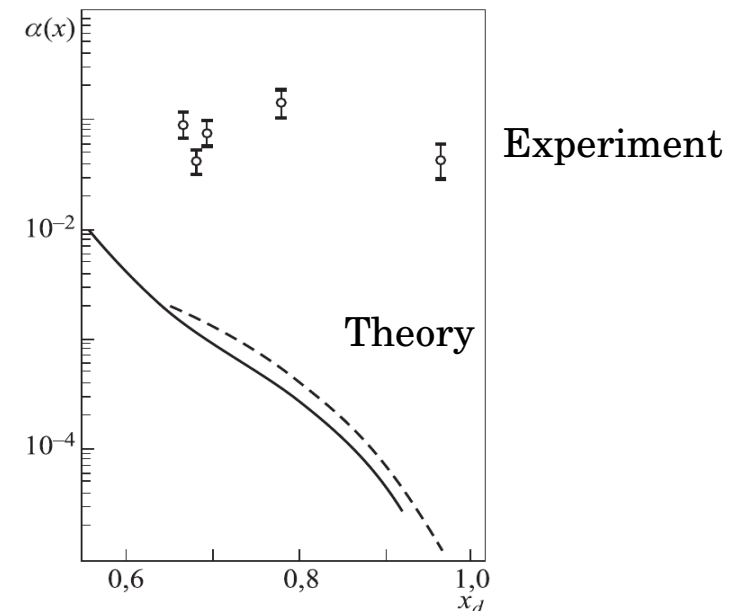
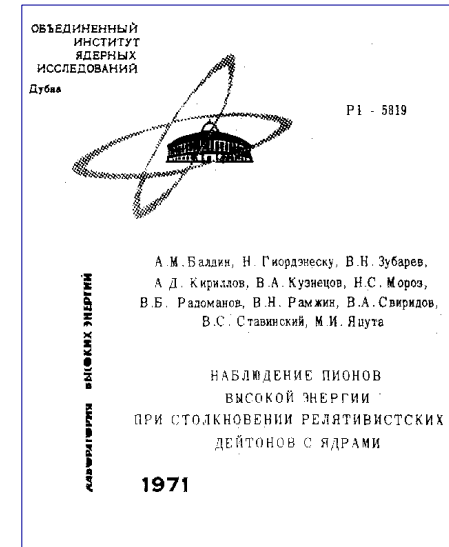
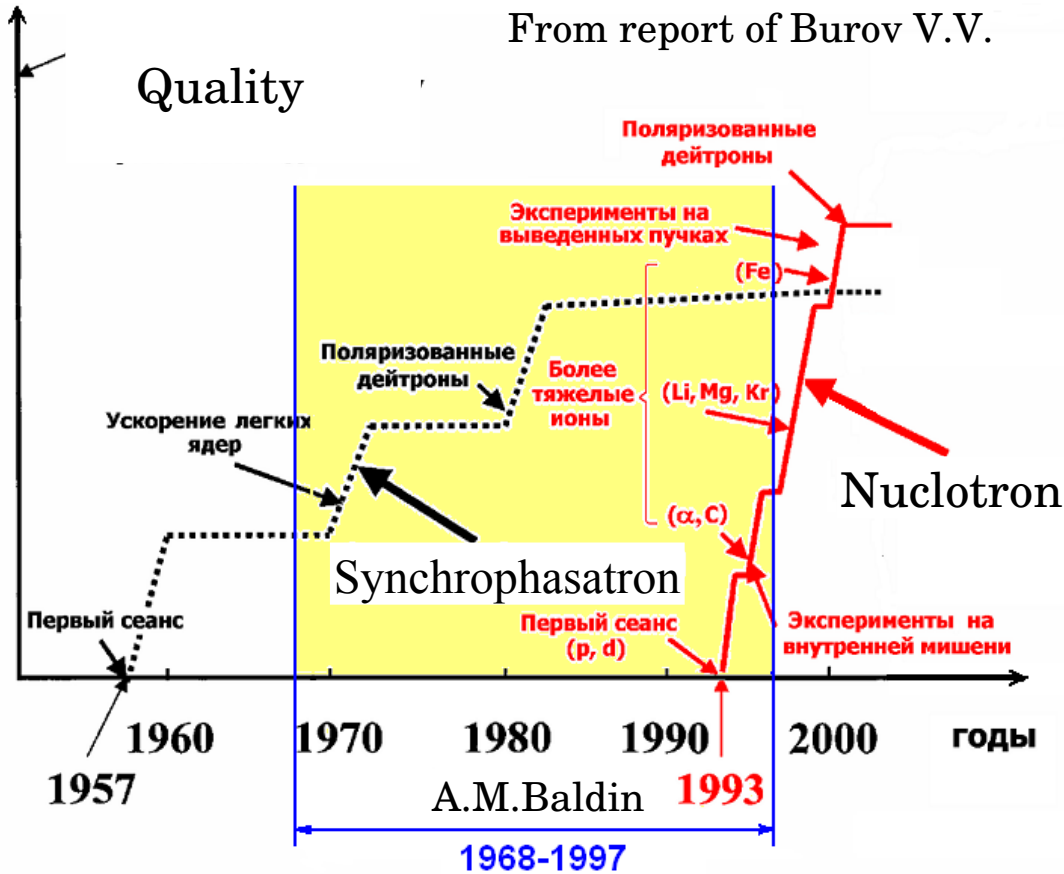

$$\alpha(x_d) = \frac{d^2\sigma(d + \text{Cu} \rightarrow \pi^- + \dots)}{d^2\sigma(p + \text{Cu} \rightarrow \pi^- + \dots)}$$

Fixed Target Experiments at Relativistic Energies

Beam energies: 100A MeV - 2A GeV

Pioneering experiments

Synchrophasotron – Dubna (1971 – 1985) DISK, 2-m B.C.

BEVALAC: Plastic Ball and Streamer Chamber (1974 - 1986)

Physics:

Collective effects => Discovery and investigation of flow effects

Equation of state (EOS) => Study of compressibility of dense nuclear matter

In-medium modifications => Kaons, low mass di-leptons

Basic result:

Nuclear matter can be compressed and high energy densities can be achieved

Heavy Ion Experiments at the AGS

(1986 - 1991):

^{16}O & ^{28}Si , $E_{\text{lab}}^{\text{max}} = 14.5 \text{ A GeV}$

(1992 - 1994): "heavy" Au ions

^{197}Au , $E_{\text{lab}}^{\text{max}} = 11.5 \text{ A GeV}$

Experiment	Beam	Technology	Observables
E802	Si	Single arm magnetic spectrometer	Spectra (π , p , K^{\pm}), HBT
E810		TPCs in magnetic field	Strangeness (K_s^0 , Λ)
E814		Magnetic spectrometer + calorimeters	Spectra (p) + E_t
E859		E802 + 2 nd level PID trigger	Strangeness (Λ)
E866	Au	2 magnetic spectrometers (TPC, TOF)	Strangeness (Kaons)
E877		Upgrade of E814	
E891		Upgrade of E810	
E895		EOS TPC	Spectra (π , p , K^{\pm}), HBT
E896		Drift chamber + neutron detector	H^0 Di-baryon, Λ
E910		EOS TPC + TOF	p+A Collisions
E917		Upgrade of E866	

5 large experiments: E802/866/917, E810, E814/877, E864, E895.

Heavy Ion Experiments at the SPS

(1976) HI 1986 – 2004

Experiment	Beam	Technology	Observables
NA34	$^{16}\text{O}, ^{32}\text{S}$	Muon spectrometer + calorimeter	Di-leptons, ρ , π , K , γ
NA35		Streamer chamber	π^- , K_s^0 , Λ , HBT
NA36		TPC	K_s^0 , Λ
NA38		Di-muon spectrometer (NA10)	Di-leptons, J/ψ
WA80/WA93		Calorimeter + Plastic Ball	γ , π^0 , η
WA85		Mag. spectrometer with MWPCs	K_s^0 , Λ , Ξ
WA94		WA85 + Si strip detectors	K_s^0 , Λ , Ξ
NA44	$^{16}\text{O}, ^{32}\text{S}, ^{208}\text{Pb}$	Single arm magnetic spectrometer	π , K^\pm , ρ
NA45		Cherenkov + TPC	Di-leptons (low mass)
NA49	^{208}Pb	Large volume TPCs	π , K^\pm , ρ , K_s^0 , Λ , Ξ , Ω , ...
NA50		NA38 upgrade	Di-leptons, J/ψ
NA52		Beamline spectrometer	Strangelets
WA97		Mag. spectrometer with Si tracker	h^- , K_s^0 , Λ , Ξ , Ω
WA98		Pb-glass calorimeter + mag. spectrom.	γ , π^0 , η
NA57		WA97 upgrade	h^- , K_s^0 , Λ , Ξ , Ω
NA60	^{114}In	NA50 + Si vertex tracker	Di-leptons, J/ψ

Heavy Ion Experiments at the SIS18

Experiment	Beams	Technology	Observables
FOPI 1991 - 2010	Au+Au 0.09 – 1.5 AGeV Ni+Ni 0.09–1.9 AGeV Ca+Ca 0.4–2.0 AGeV	Forward Plastic Wall Jet type drift chamber Multi-gap RPC LAND	Fragments production Flow systematics, Mesons production Stopping power
HADES 1996 - ...	C+C 1 and 2 GeV/u Ar+KCl 1.75 GeV/u p+p 1.25, 2.2, 3.5 GeV d+p 1.25 GeV/u p+Nb 3.5 GeV	hadron-blind RICH detector Mini Drift Chambers TOF scintillators RPC	vector-meson decays ρ , ω , and $\phi \rightarrow e + e^-$
KAON 1993 - 2005	Au+Au 1 AGeV	MWPC Plastic scintillators	kaon and antikaon production

Onset of deconfinement (NA49/61)

Statistical Model of the Early Stage

Gazdzicki M. Gorenstein M.
Acta. Phys. Pol., B30: 2705 1999

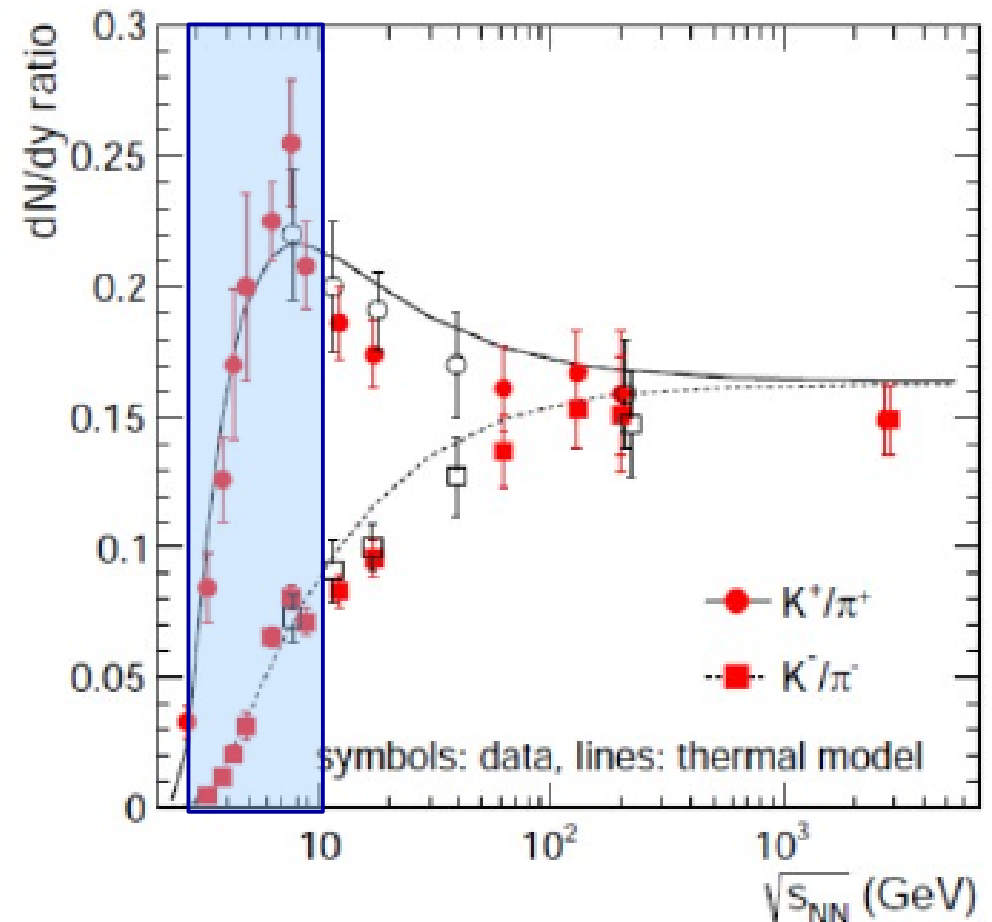
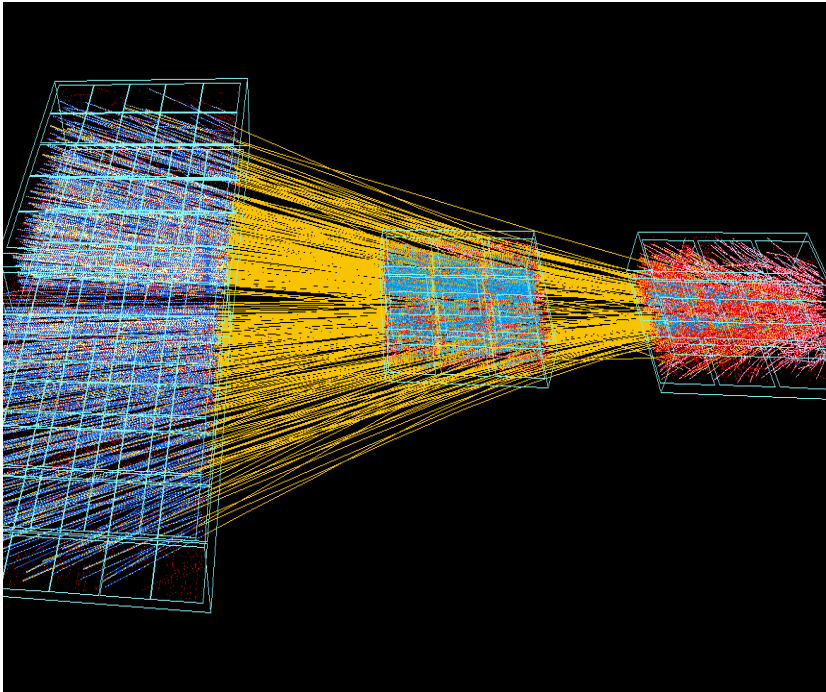

NA49 energy&species scan

arXiv:nucl-ex/0612007

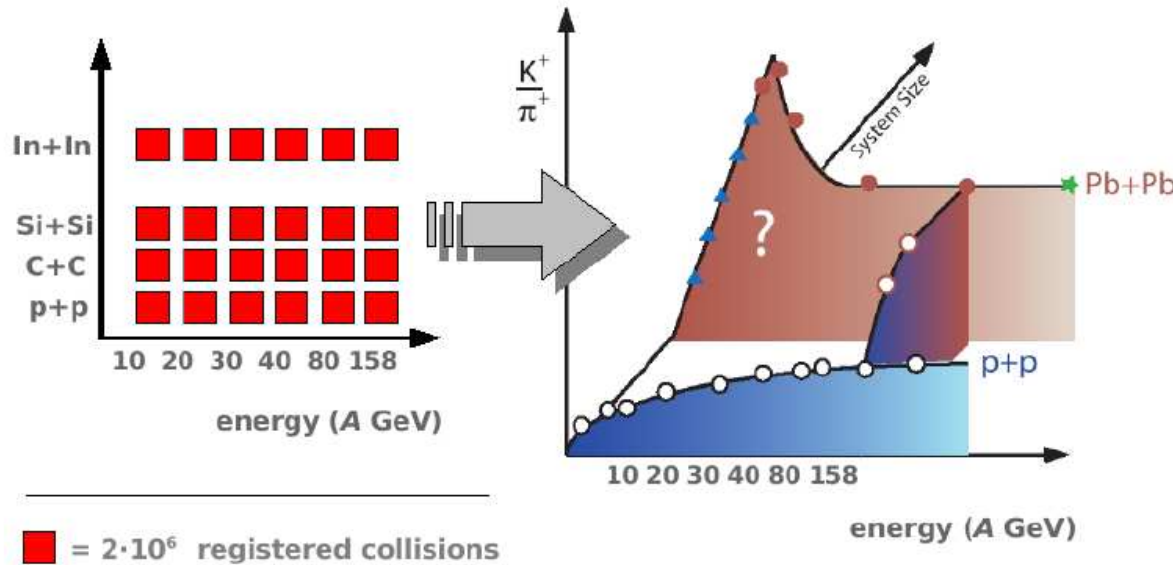

Horn
vanishing

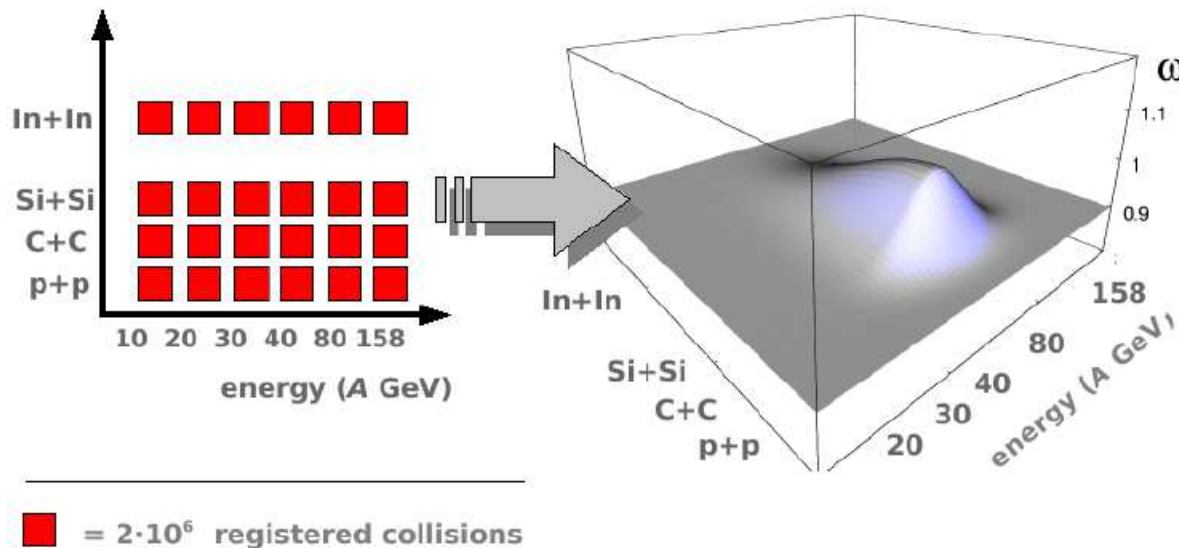

The scaled variance of the multiplicity distribution of negatively charged hadrons in the projectile hemi-sphere

RHIC

BNL-RHIC (from 2000):

$\sqrt{s} = 200 \text{ GeV}$, Au + Au collisions

4 large experiments: BRAHMS, PHENIX, PHOBOS, STAR.

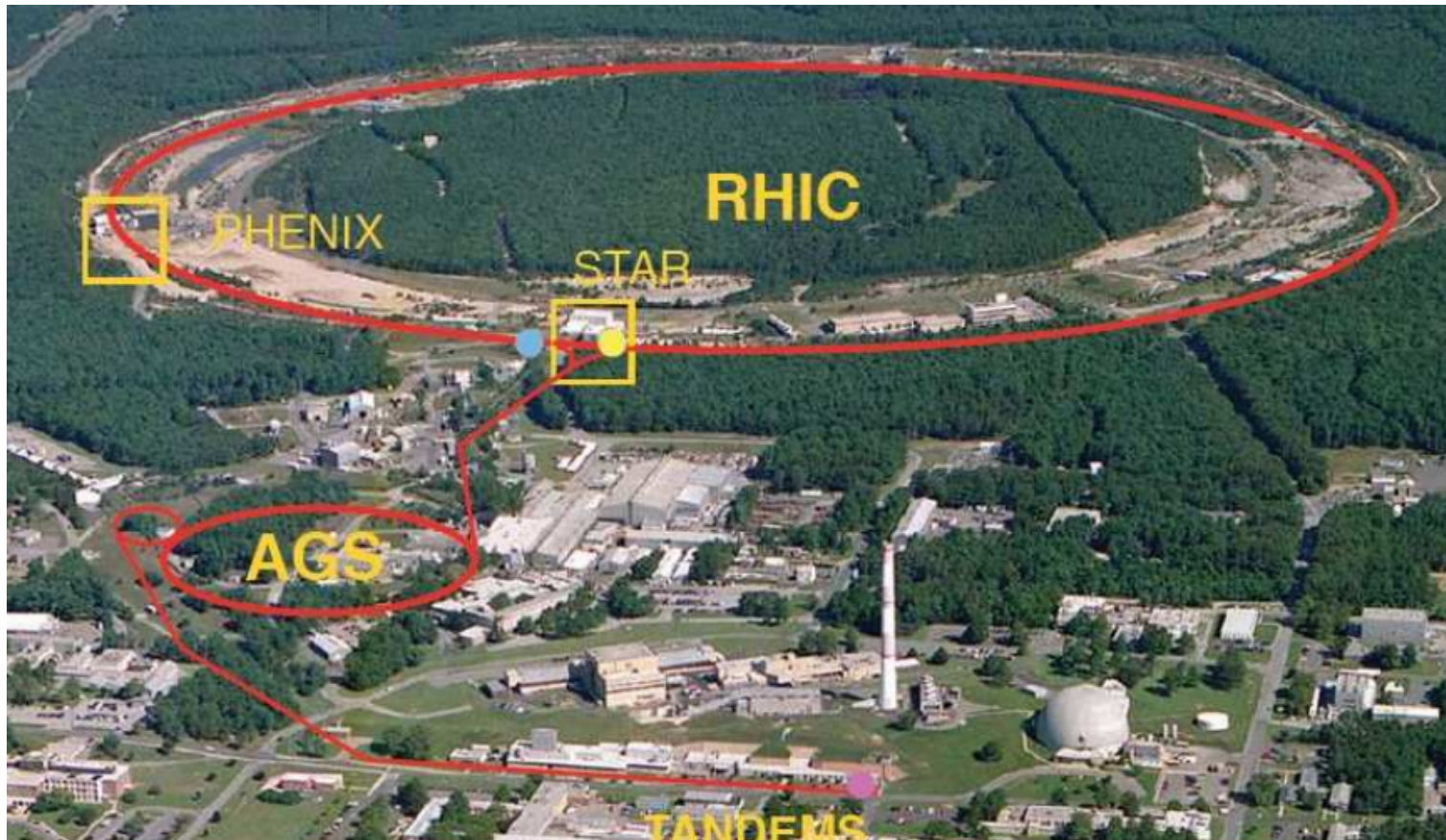

STAR BES program (2005)

BES-Short-v8.3_0

Experimental Study of the QCD Phase Diagram and
Search for the Critical Point:
Selected Arguments for the Run-10 Beam Energy Scan
at RHIC

The STAR Collaboration (B. I. Abelev et al.)

Introduction & Summary

We present an overview of the main ideas that have emerged from discussions within STAR for the Beam Energy Scan (BES). The formulation of this concise and abridged document is facilitated by the existence of a much longer and more comprehensive companion document entitled Experimental Exploration of the QCD Phase Diagram: Search for the Critical Point [1].:

A. A search for turn-off of new phenomena already established at higher RHIC energies; QGP signatures are the most obvious example, but we define this category more broadly. If our current understanding of RHIC physics and these signatures is correct, **a turn-off must be observed in several signatures, and such corroboration is an essential part of the “unfinished business” of QGP discovery [2].**

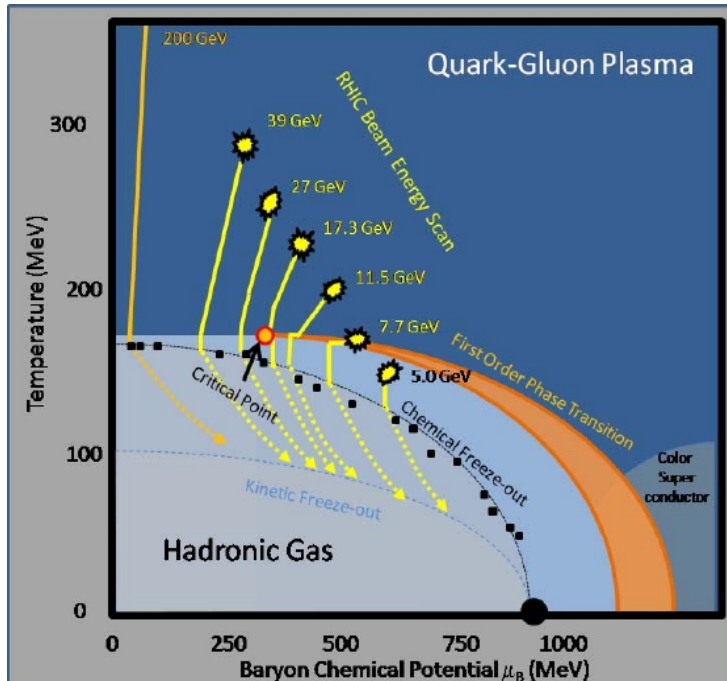

STAR BES QGP signatures

The particular observables that STAR has identified as the essential drivers of our run plan are:

- (A-1) Constituent-quark-number scaling of v_2 , indicating partonic degrees of freedom;
- (A-2) Hadron suppression in central collisions as characterized by the ratio R_{cp} ;
- (A-3) Untriggered pair correlations in the space of pair separation in azimuth and pseudorapidity, which elucidate the ridge phenomenon;
- (A-4) Local parity violation in strong interactions, an emerging and important RHIC discovery in its own right, is generally believed to require deconfinement, and thus also is expected to turn-off at lower energies.

A search for signatures of a phase transition and a critical point. The particular observables that we have identified as the essential drivers of our run plan are:

- (B-1) Elliptic & directed flow for charged particles and for identified protons and pions, which have been identified by many theorists as highly promising indicators of a “softest point” in the nuclear equation of state;
- (B-2) Azimuthally-sensitive femtoscopy, which adds to the standard HBT observables by allowing the tilt angle of the ellipsoid-like particle source in coordinate space to be measured; these measurements hold promise for identifying a softest point, and complements the momentum-space information revealed by flow measurements, and
- (B-3) Fluctuation measures, indicated by large jumps in the baryon, charge and strangeness susceptibilities, as a function of system temperature – the most obvious expected manifestation of critical phenomena.

STAR BES I results

High P_T suppression

Stephen Horvat Quark Matter 2015

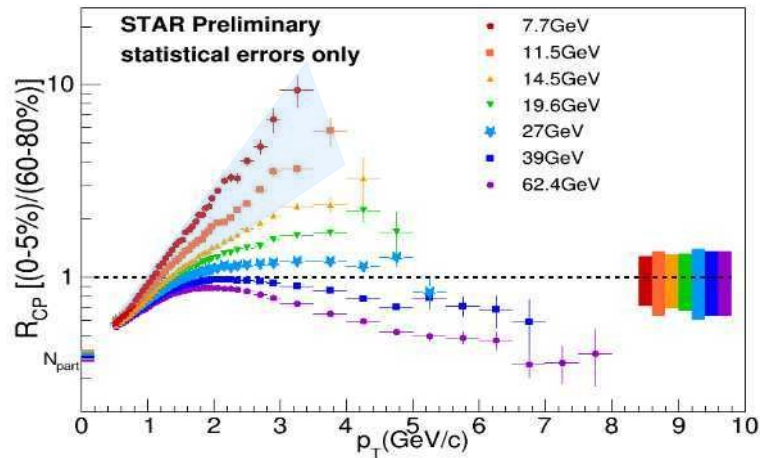

Number of constituent quarks scaling

Phys. Rev. C88, (2013), 014902

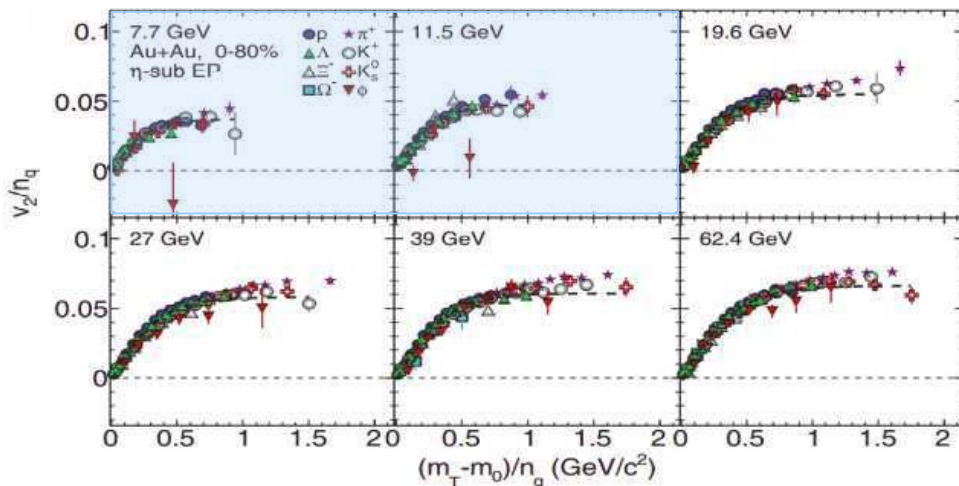

Chiral Magnetic Effect

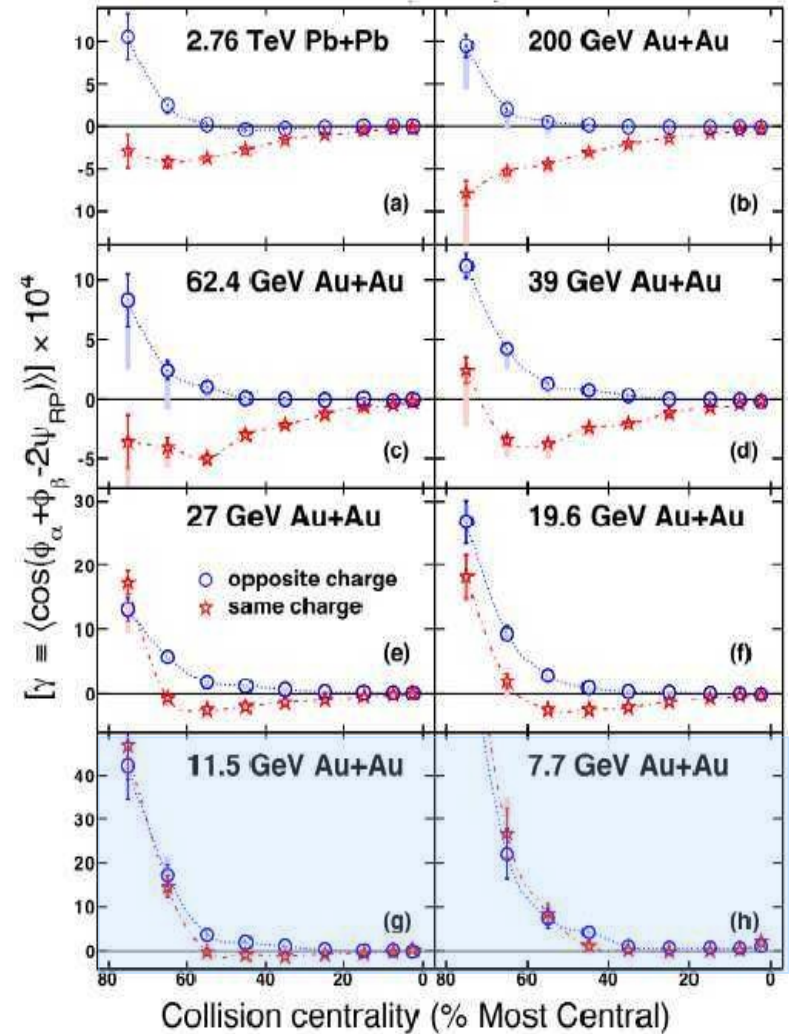

STAR BES I results

S. Jowzaee, Quark Matter 2017

Ridge effect

B. Abelev et al., Phys. Rev. C80, 064912 (2009).

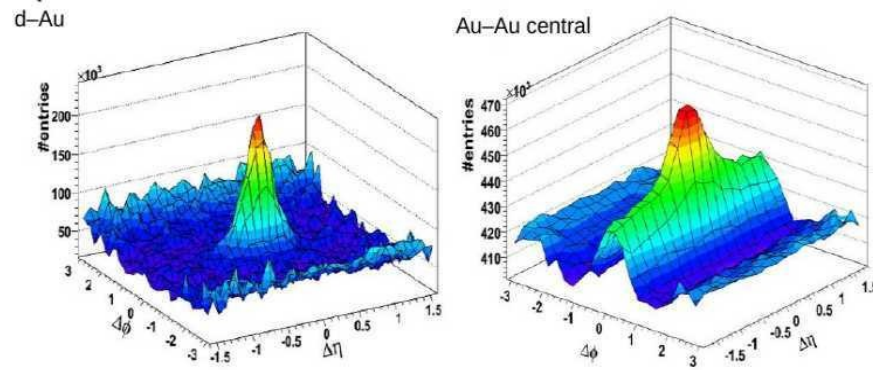

h^+h^+ , Au+Au, 19.6GeV, 0-5%

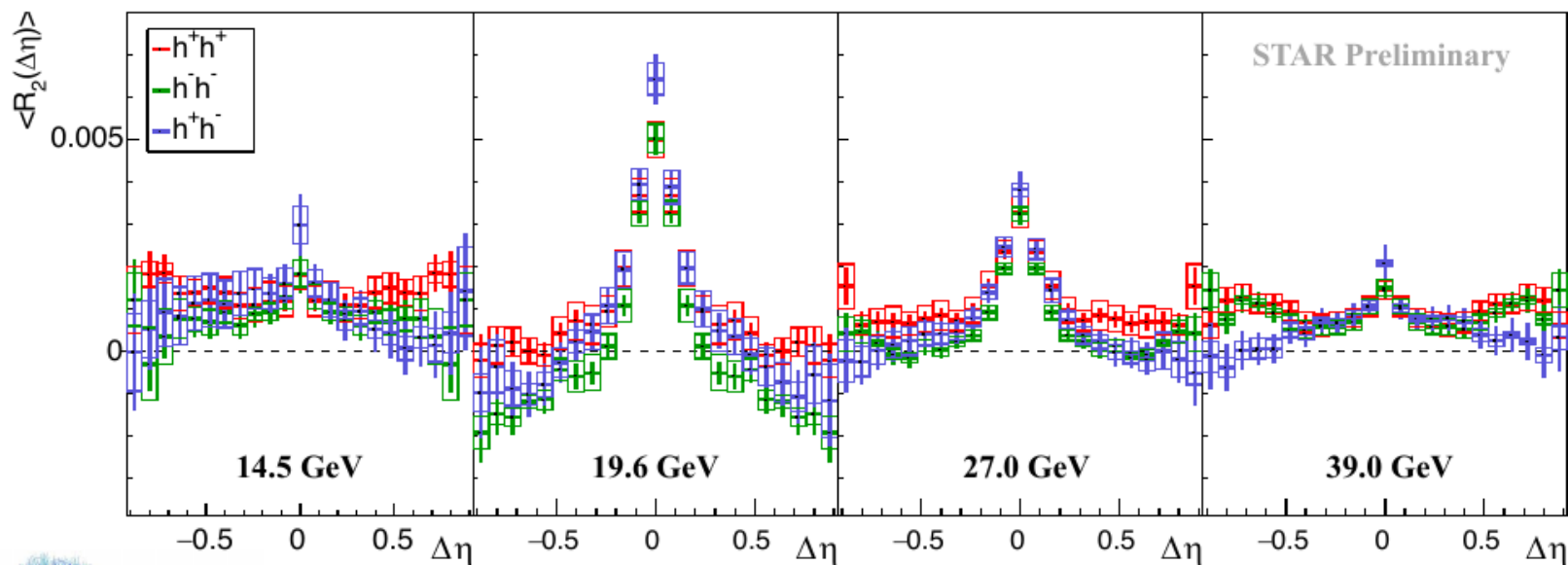
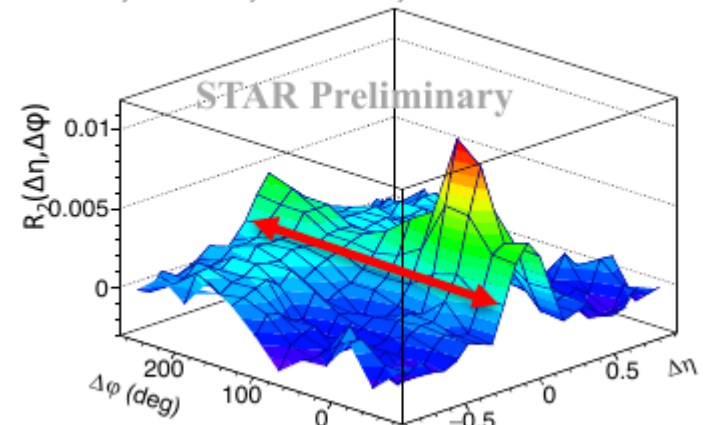

STAR BES I results

PRL 112 (2014) 162301

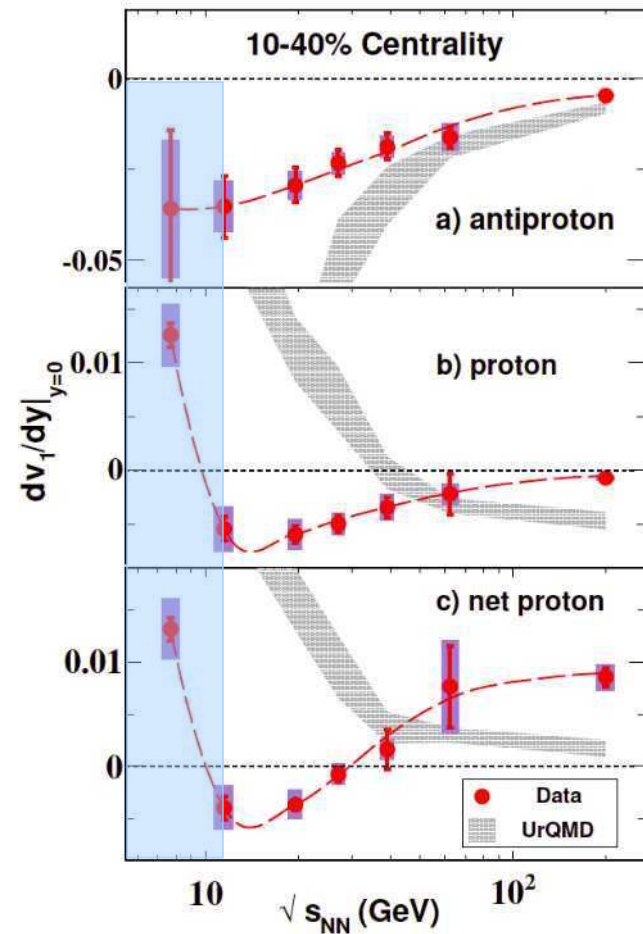

R. Lacey, PRL 114, 142301 (2015)

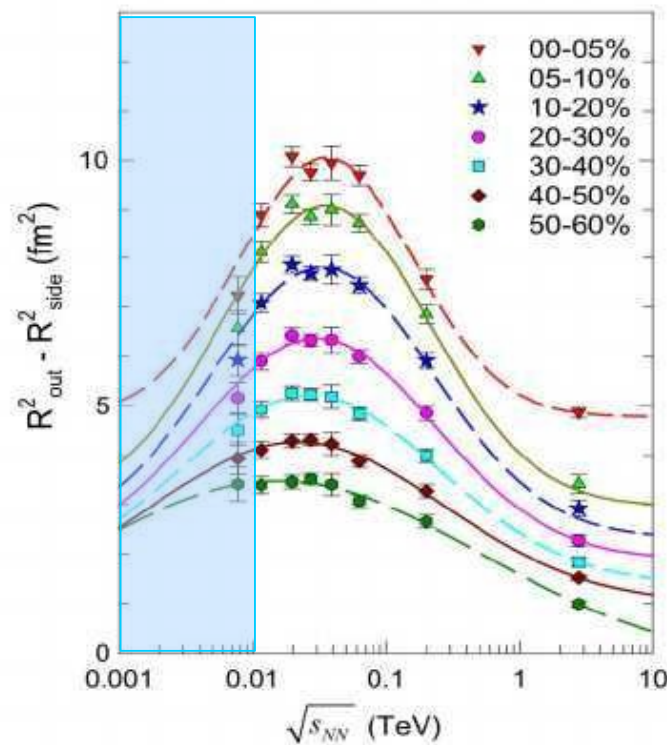

STAR, PRL 112, 032302 (2014)

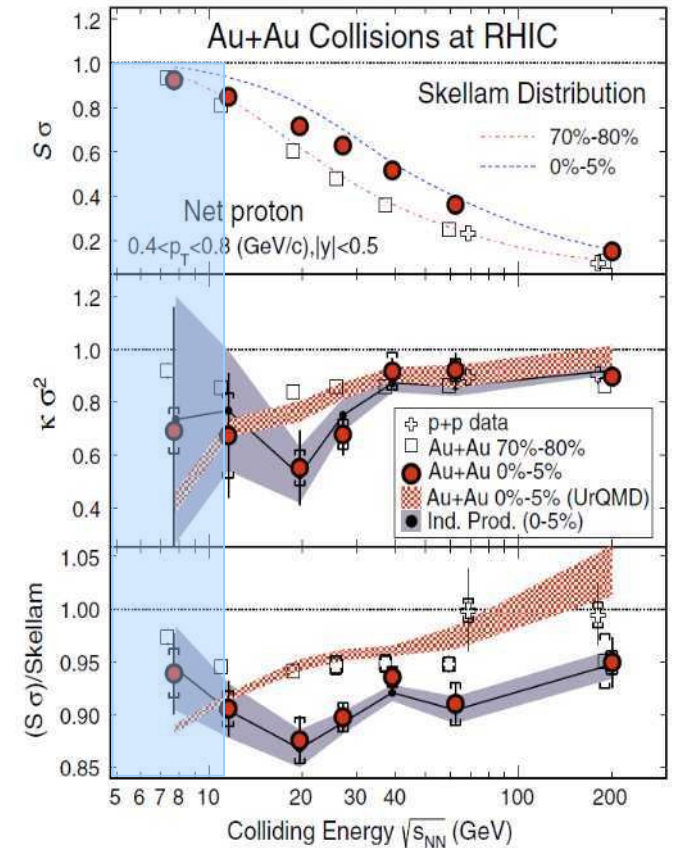

STAR BES I results

PRL 112 (2014) 162301

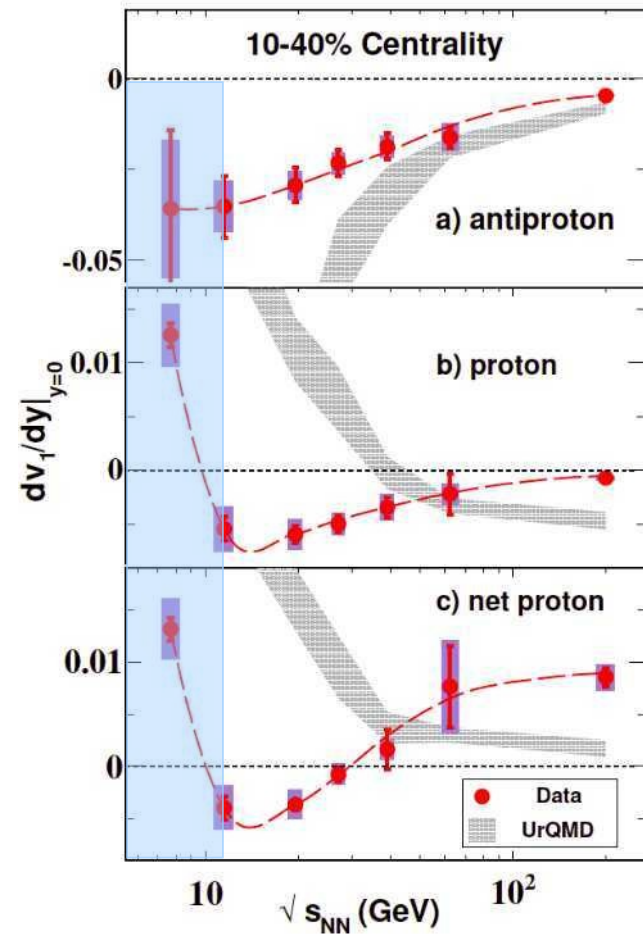

The rapidity-slope of the net proton directed flow v_1 , dv_1/dy . This quantity is sensitive to early pressure gradients in the medium.

$R_{out}^2 - R_{side}^2$ - reflects the lifetime of the collision fireball and was predicted to reach a maximum for collisions in which a hydrodynamic fluid forms at temperatures where the equation of state is softest.

R. Lacey, PRL 114, 142301 (2015)

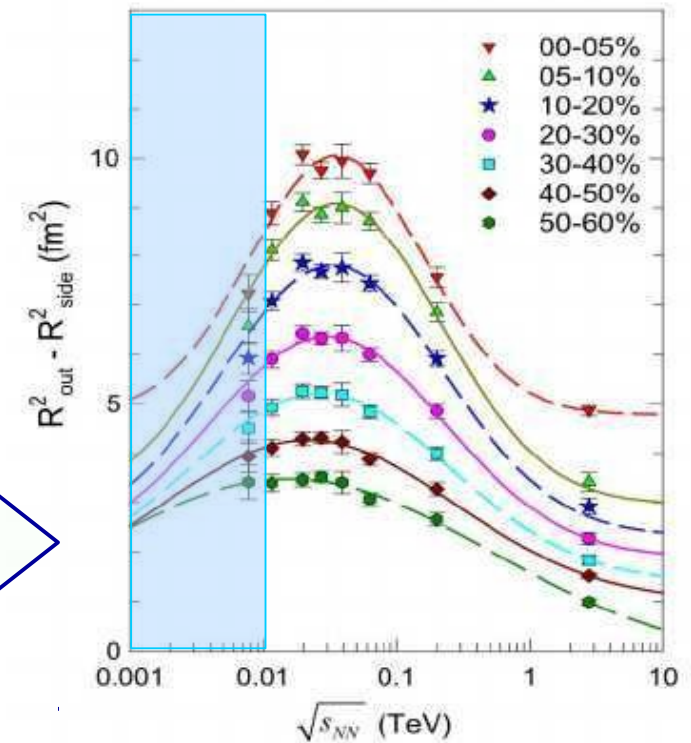

STAR BES I results

STAR, PRL 112, 032302 (2014)

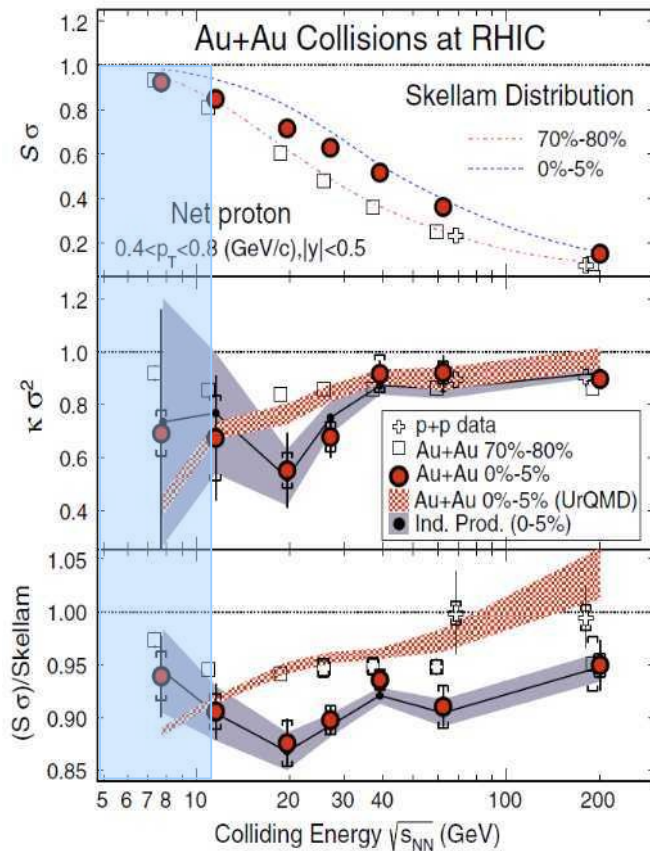

The kurtosis of the event-by-event distribution of the net proton (i.e. proton minus antiproton) number per unit of rapidity, normalized such that Poisson fluctuations give a value of 1.

In central collisions, published results in a limited kinematic range show a drop below the Poisson baseline around $\sqrt{s_{NN}} = 27$ and 19.6 GeV.

New preliminary data over a larger p_T range, although at present still with substantial error bars, hint that the normalized kurtosis may, in fact, rise above 1 at lower $\sqrt{s_{NN}}$, as expected from critical fluctuations..

The grey band shows the much reduced uncertainties anticipated from BES-II in 2018-2019, for the 0-5% most central collisions.

STAR BES II program

$\sqrt{s_{NN}}$ (GeV)	μ_B (MeV)	MinBias Events (10^6)	Time (weeks)	Year
7.7	420	4.3	4	2010
11.5	315	11.7	2	2010
14.5	260	24.0	3	2014
19.6	205	35.8	1.5	2011
27.0	155	70.4	1	2011
39.0	115	130.4	2	2010
62.4	70	67.3	1.5	2010

$\sqrt{s_{NN}}$ (GeV)	μ_B (MeV)	Needed Events (10^6)
7.7	420	100
9.1	370	160
11.5	315	230
14.5	260	300
19.6	205	400

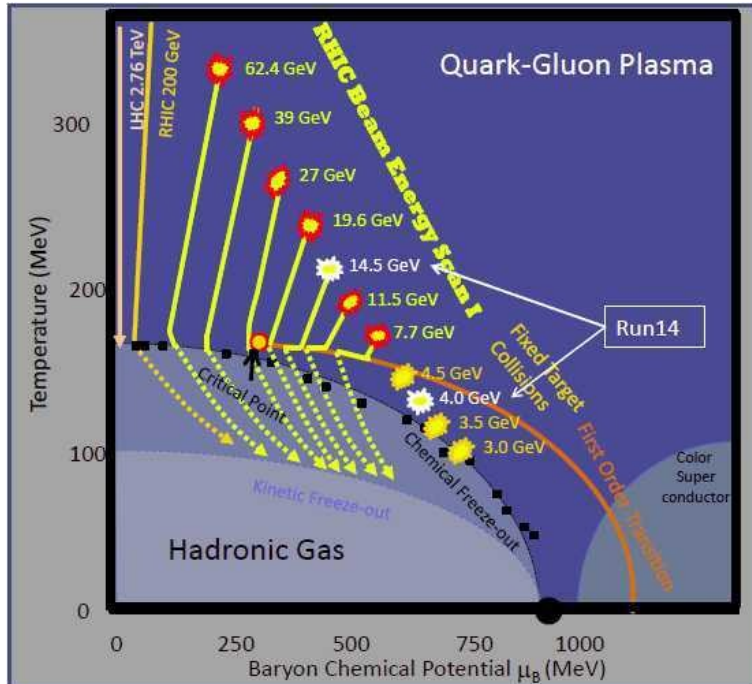

Year	System and Energy	Physics/Observables	Upgrade
2017	<ul style="list-style-type: none"> p+p @ 500 GeV Au+Au @ 62.4 GeV 	<ul style="list-style-type: none"> Spin sign change diffractive Jets 	FMS post-shower, EPD (1/8 th), eTOF prototype
2018	<ul style="list-style-type: none"> Zr+Zr, Ru+Ru @ 200 GeV Au+Au @ 27 GeV 	<ul style="list-style-type: none"> CME, di-leptons CVE 	Full EPD? eTOF prototype
2019	Au+Au @ 14.5-20 GeV + fixed target	<ul style="list-style-type: none"> QCD critical point Phase transition CME, CVE,... 	Full iTPC, eTOF, and EPD
2020	Au+Au @ 7-11 GeV + fixed target	<ul style="list-style-type: none"> QCD critical point Phase transition CME, CVE,... 	
2020+	<ul style="list-style-type: none"> Au+Au @ 200 GeV p+A/p+p @ 200 GeV 	<ul style="list-style-type: none"> Unbiased jets, open beauty PID FF, Drell-Yan, longitudinal correlations 	<ul style="list-style-type: none"> HFT+ FCS, FTS

Baryon stopping power

3FD

+ MPD sim.

$$C_y = \left(y_{\text{beam}}^3 \frac{d^3 N}{dy^3} \right)_{y=0} / \left(y_{\text{beam}} \frac{dN}{dy} \right)_{y=0} = (y_{\text{beam}}/w_s)^2 (\sinh^2 y_s - w_s \cosh y_s)$$

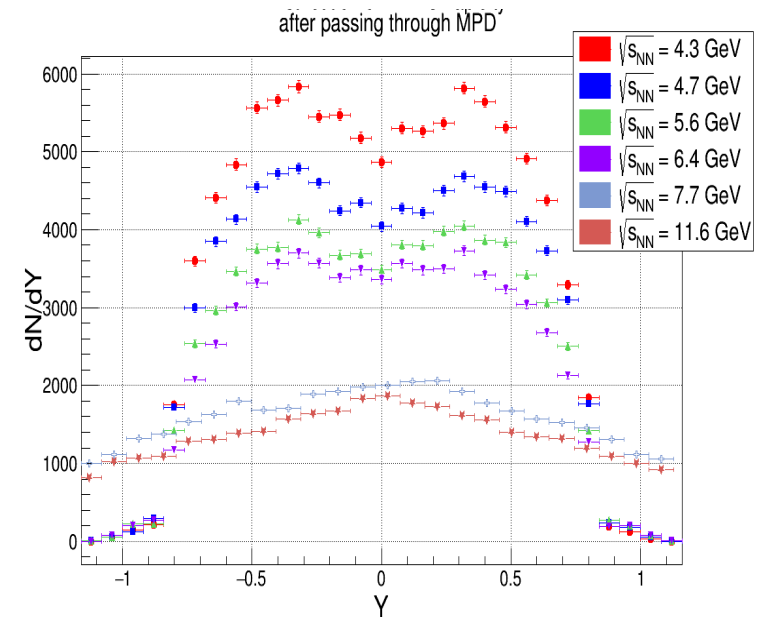
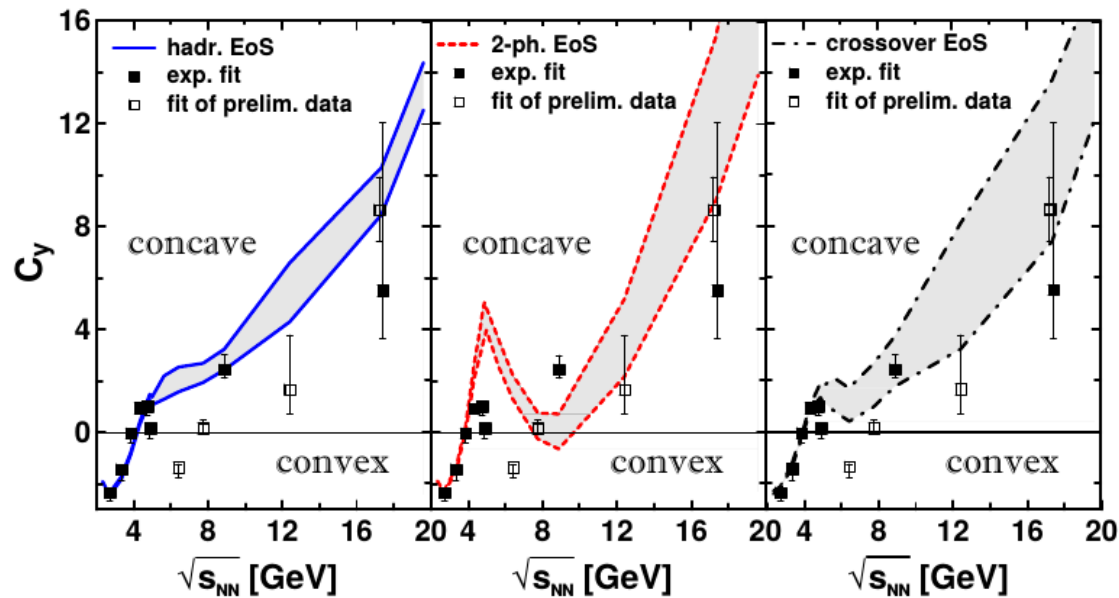

Yu.B. Ivanov, PL B721 (2013) 123
arXiv:1211.2579

global Λ polarization for MPD

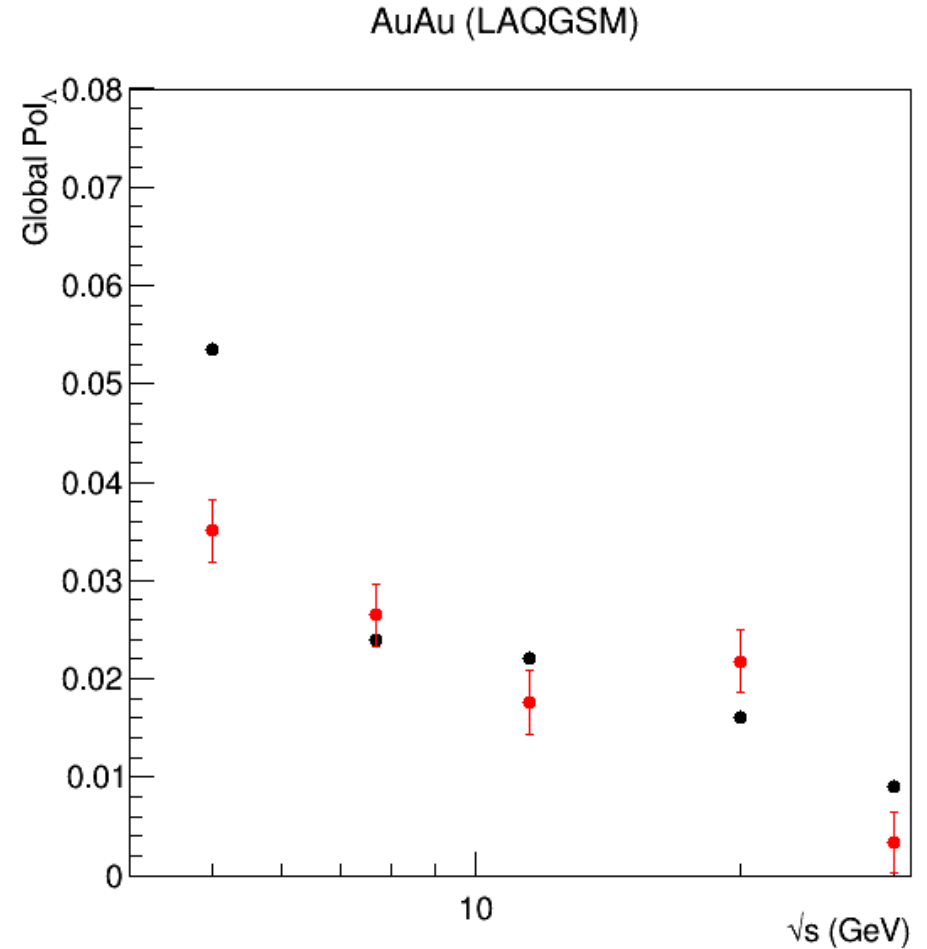
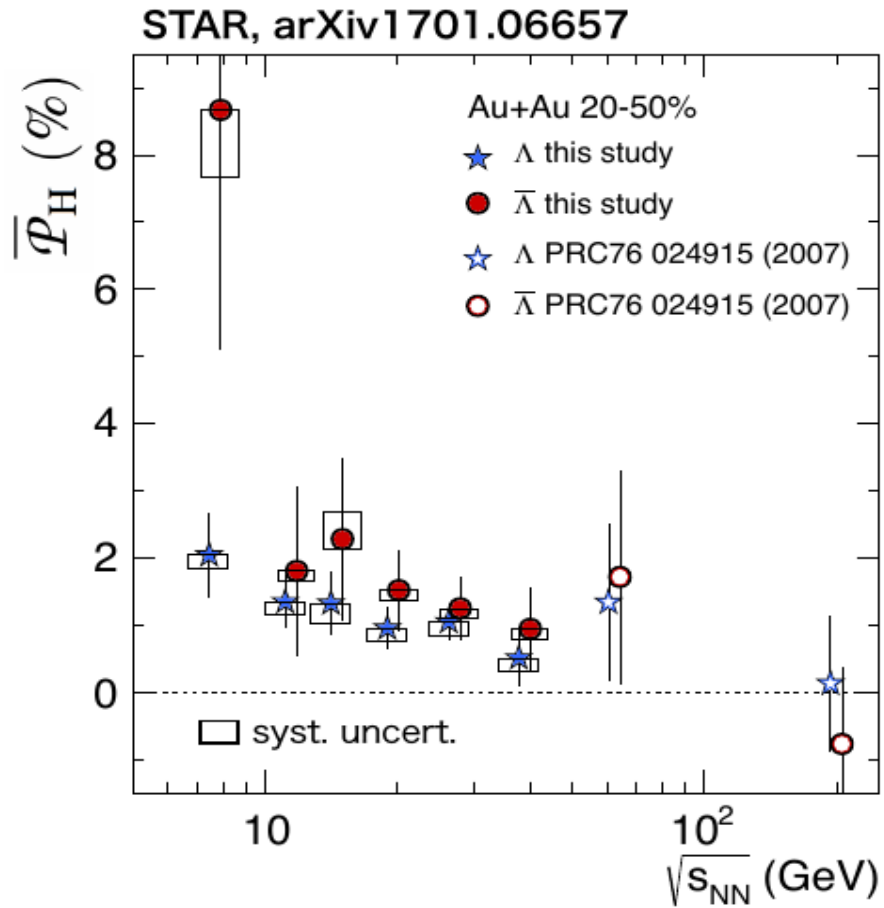

QCD Phase diagram

Grazyna Odyniec JoP 455 (2013) 012037

STAR

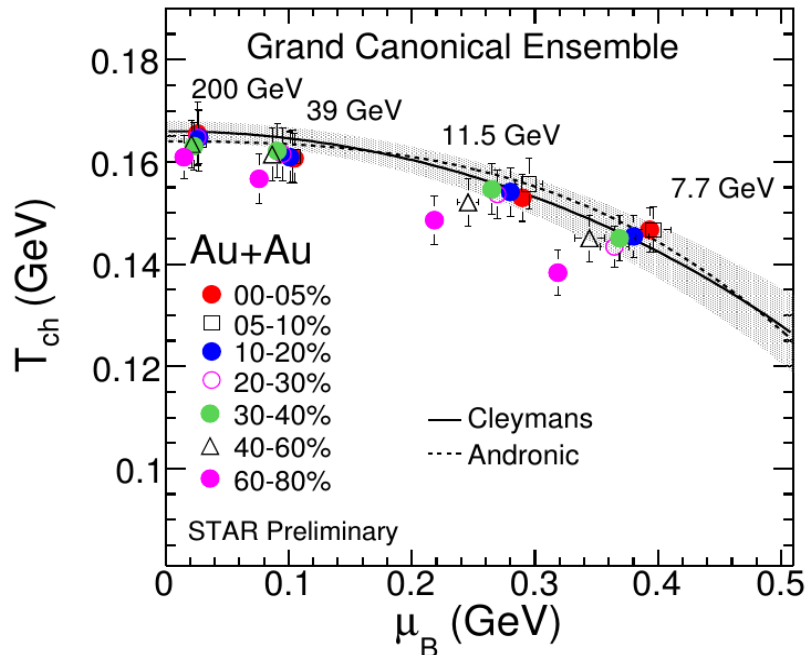

The dependence of T_{ch} on μ_B , fitted with the Grand Canonical approach in THERMUS Model

STAR + ALICE

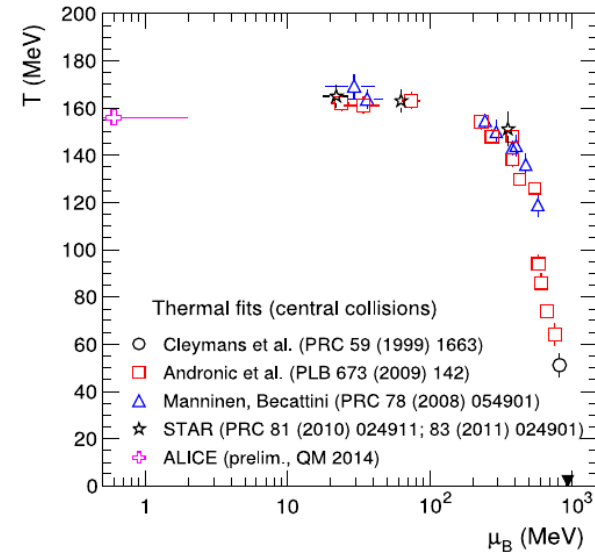

Eur. Phys. J. A (2016) 52: 324

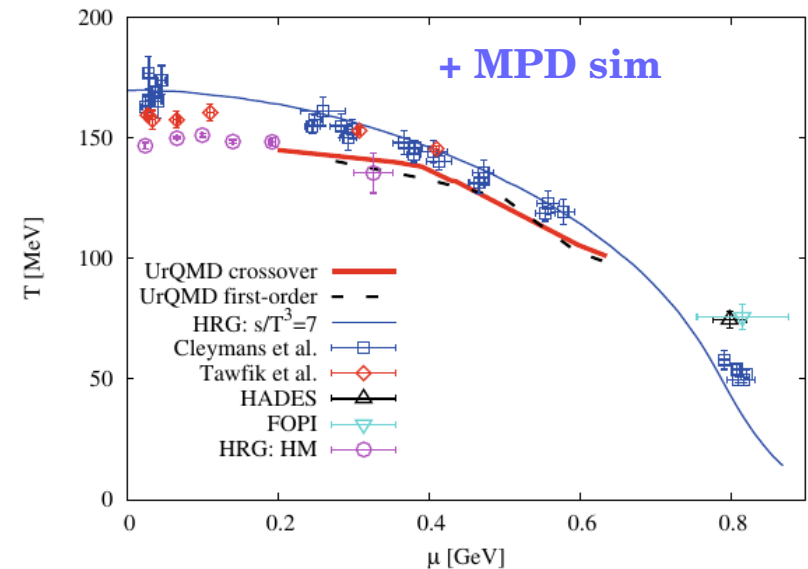

NICA Physics feasibility study

	LAQGSM	PHSD (SACA)	vHLL	3FD	UrQMD (Hybrid)
Strangeness					✓
Femtoscscopy			ArXiv 1703.09628		
Flow	✓	✓			
Fragments+hyper		✓			
Stopping power				Phys. Rev. C 94, 044917	
CME		✓			
Λ polarization	✓				
Vorticity	✓			✓	
Dileptons		✓			
Freezout par.					Eur. Phys. J. A (2016) 52: 324

Current & future HI experiments

Facility	SPS	RHIC BES II	Nuclotron- M	NICA	SIS/100 (500) ?	LHC
Laboratory	CERN Geneva	BNL Brookhaven	JINR Dubna	JINR Dubna	FAIR GSI Darmstadt	CERN Geneva
Experiment	NA61 SHINE	STAR PHENIX	BM@N	MPD	HADES CBM	ALICE ATLAS CMS
Start of data taking	2011	2010	2015	2020	2020/25	2009
\sqrt{s}_{NN}	4.9 – 17.3	7.7 – 200	< 3.5	4 - 11	2.3 – (4.5)	up to 5500
Physics	CP & OD	CP & OD	HDM	OD & HDM	OD & CP	PDM

CP — critical point
 OD — onset of deconfinement, mixed phase, 1st order phase transition
 HDM — hadrons in dense matter
 PDM — properties of deconfined matter

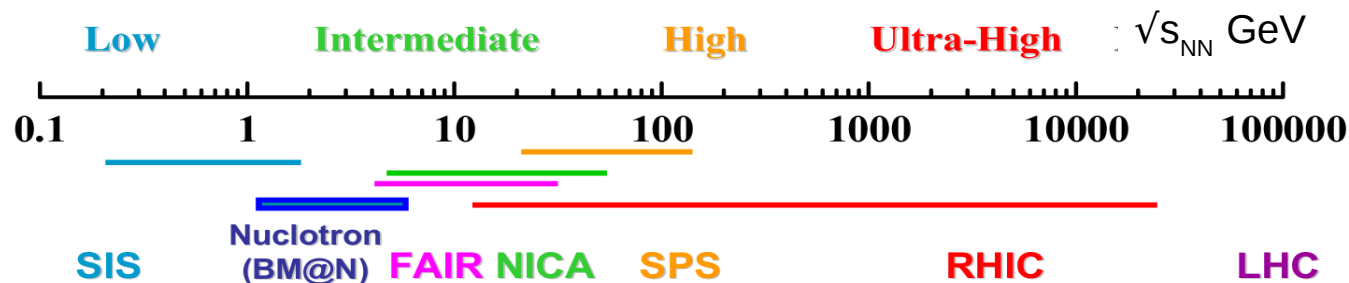

Nuclotron based Ion Collider facility

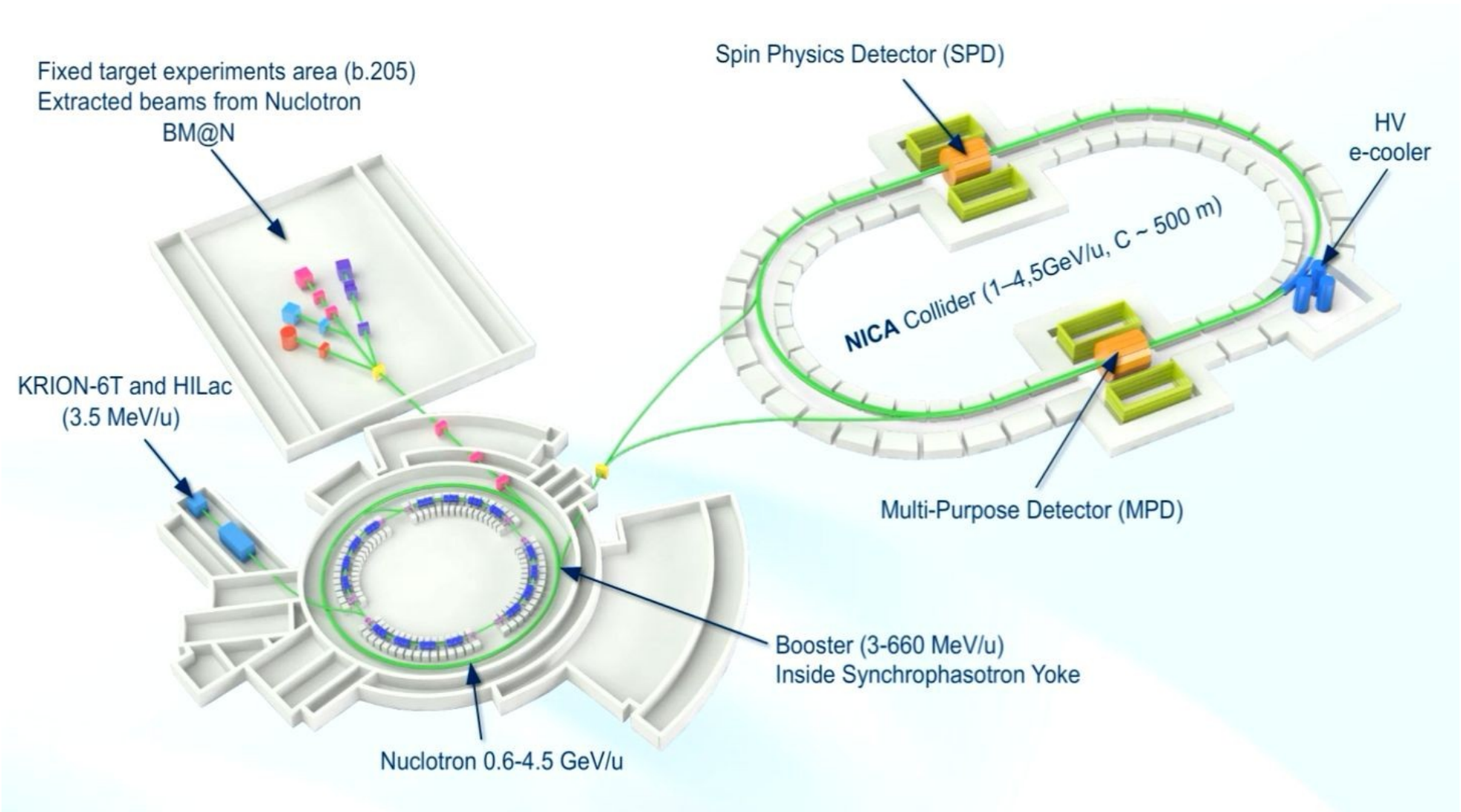

BM@N experiment at NICA

AuAu $E_{\text{beam}} = 4 \text{ GeV}$

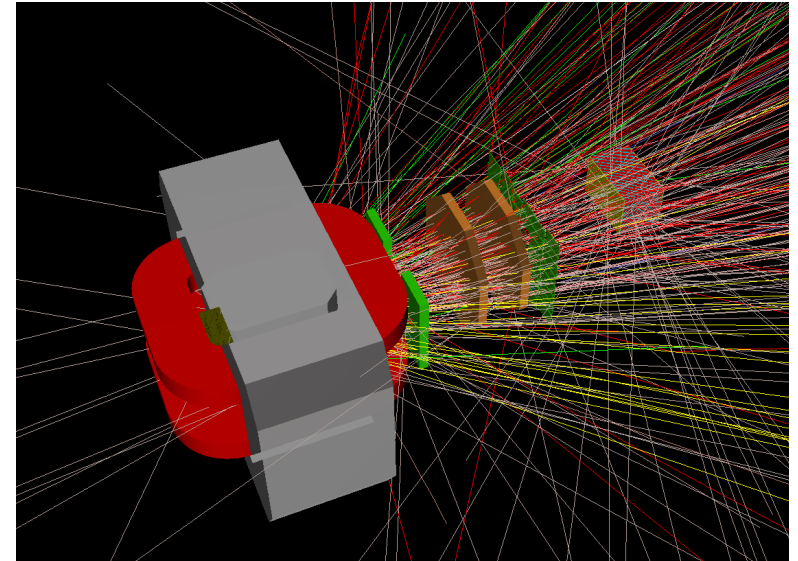
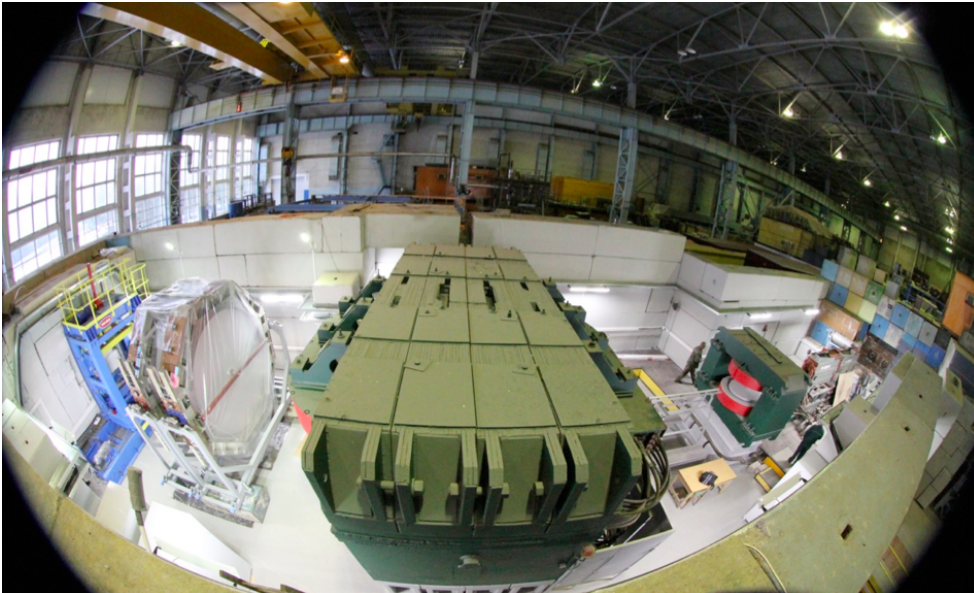

year	2016	2017 spring	2017 autumn	2019	2020 and later
beam	d(†)	C, Ar	Kr	Au	Au, p
max.inten- sity, Hz	1M	1M	1M	1M	10M
trigger rate, Hz	10k	10k	20k	20k	50k
central tracker status	6 GEM half pl.	8 GEM half pl.	10 GEM half pl.	8 GEM full pl.	12 GEMs or 8 GEMs + Si planes
experim. status	techn. run	techn. run	physics run	stage 1 physics	stage 2 physics

MPD experiment at NICA

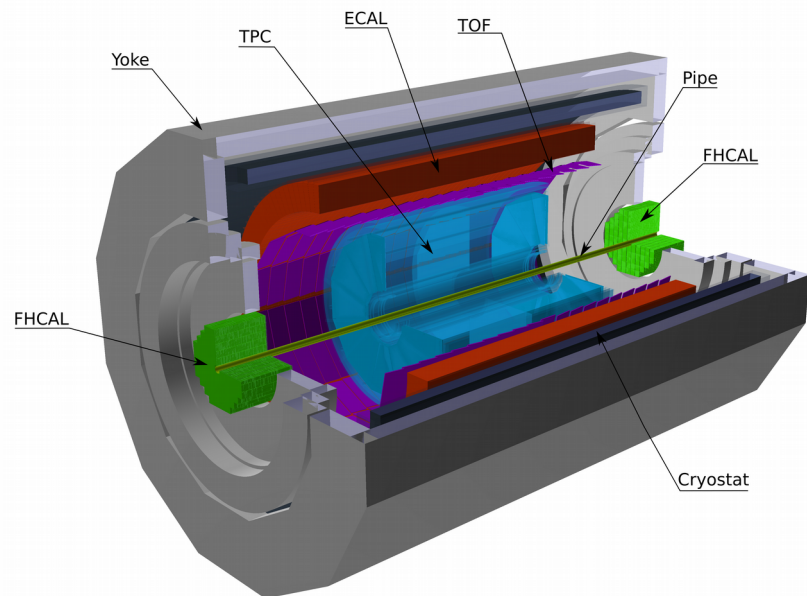
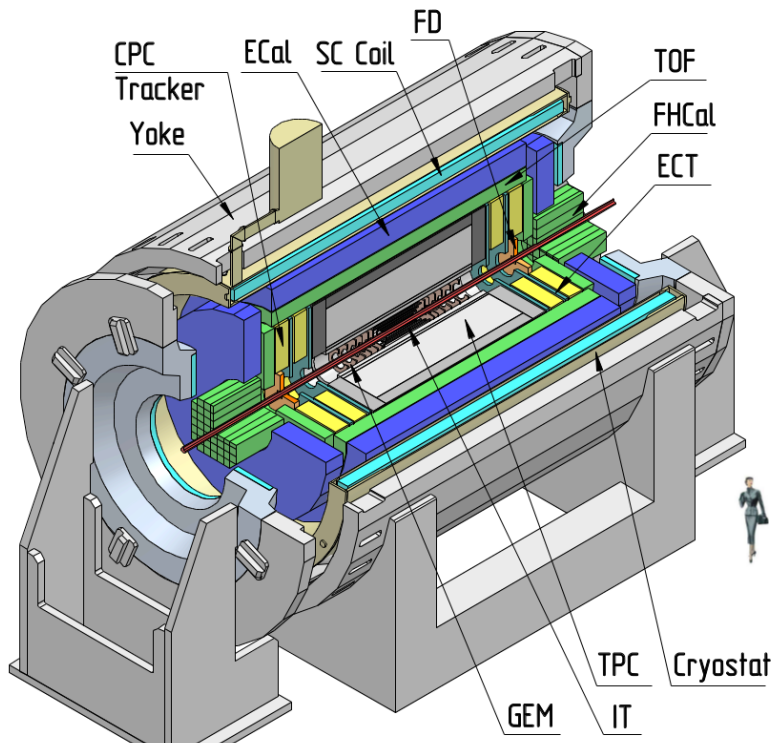

AuAu $\sqrt{s} = 11$ GeV

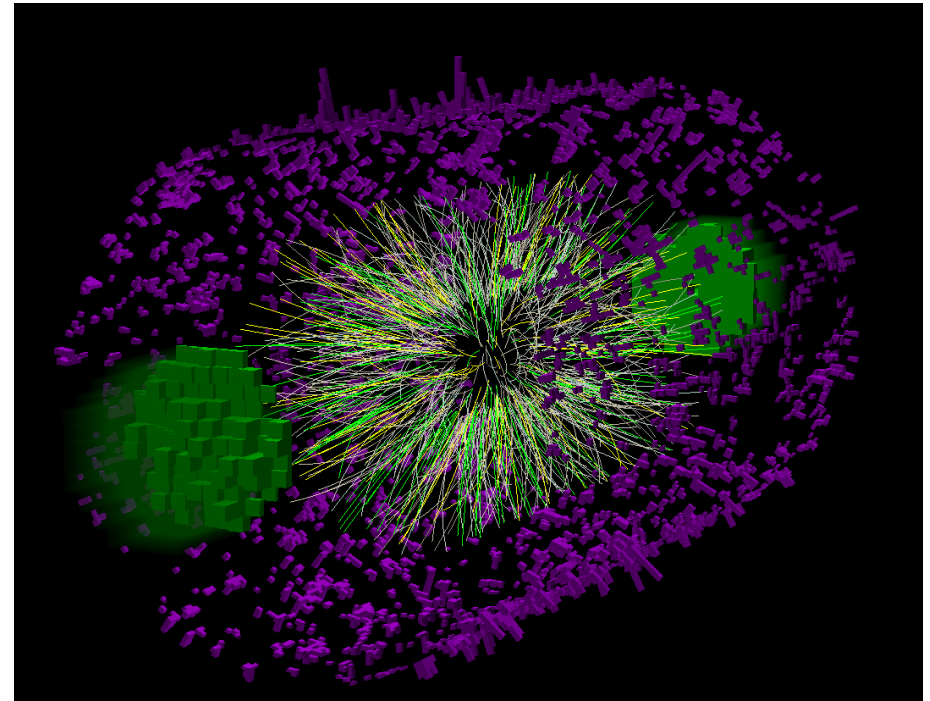

**Thank you for
attention**



Events preselection

Ex.: ALICE, Phys. Rev. C 88 (2013) 044910

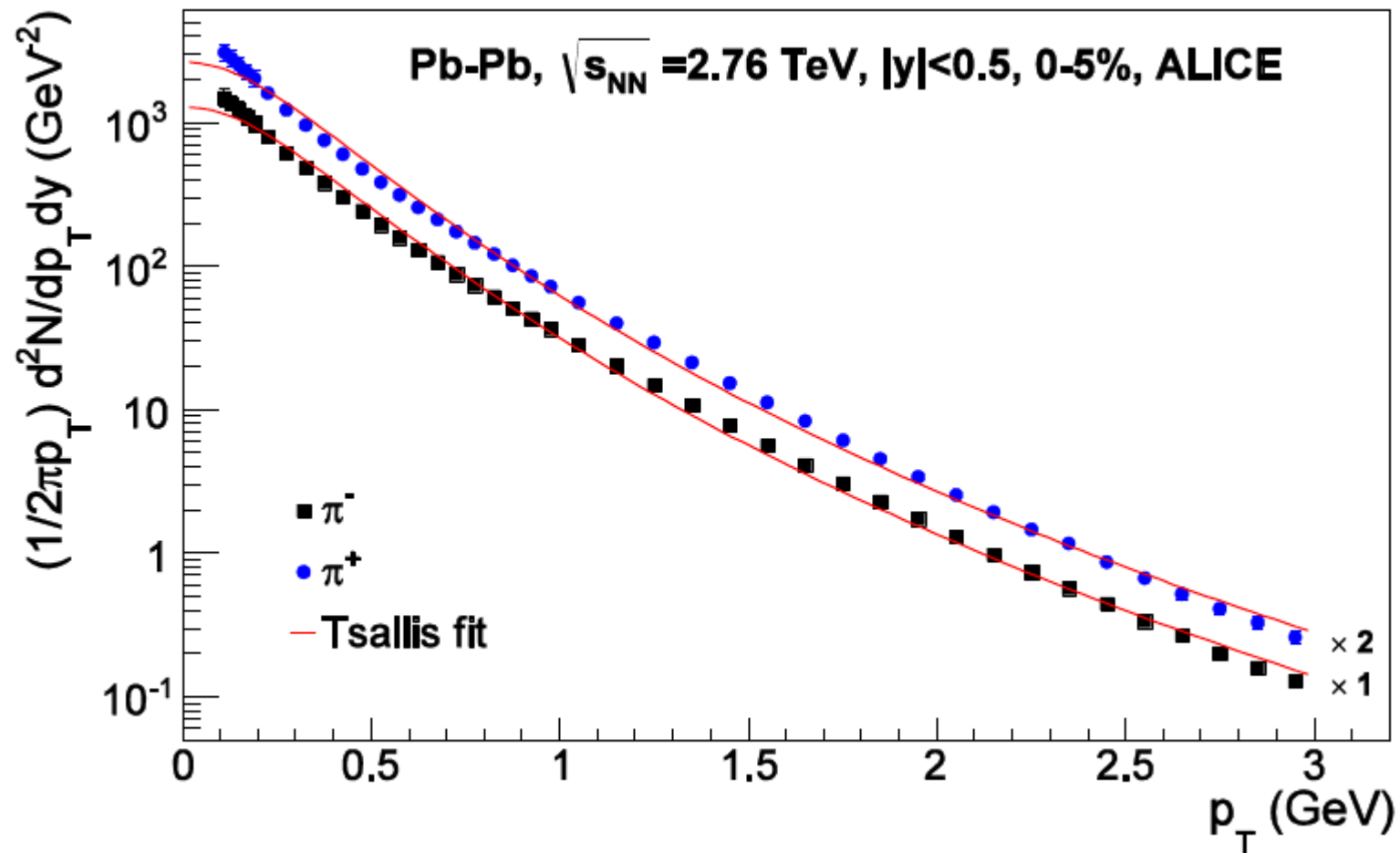

Events preselection

Pythia v.6-424
10K events $\sqrt{s} = 7$ TeV
all charged particles

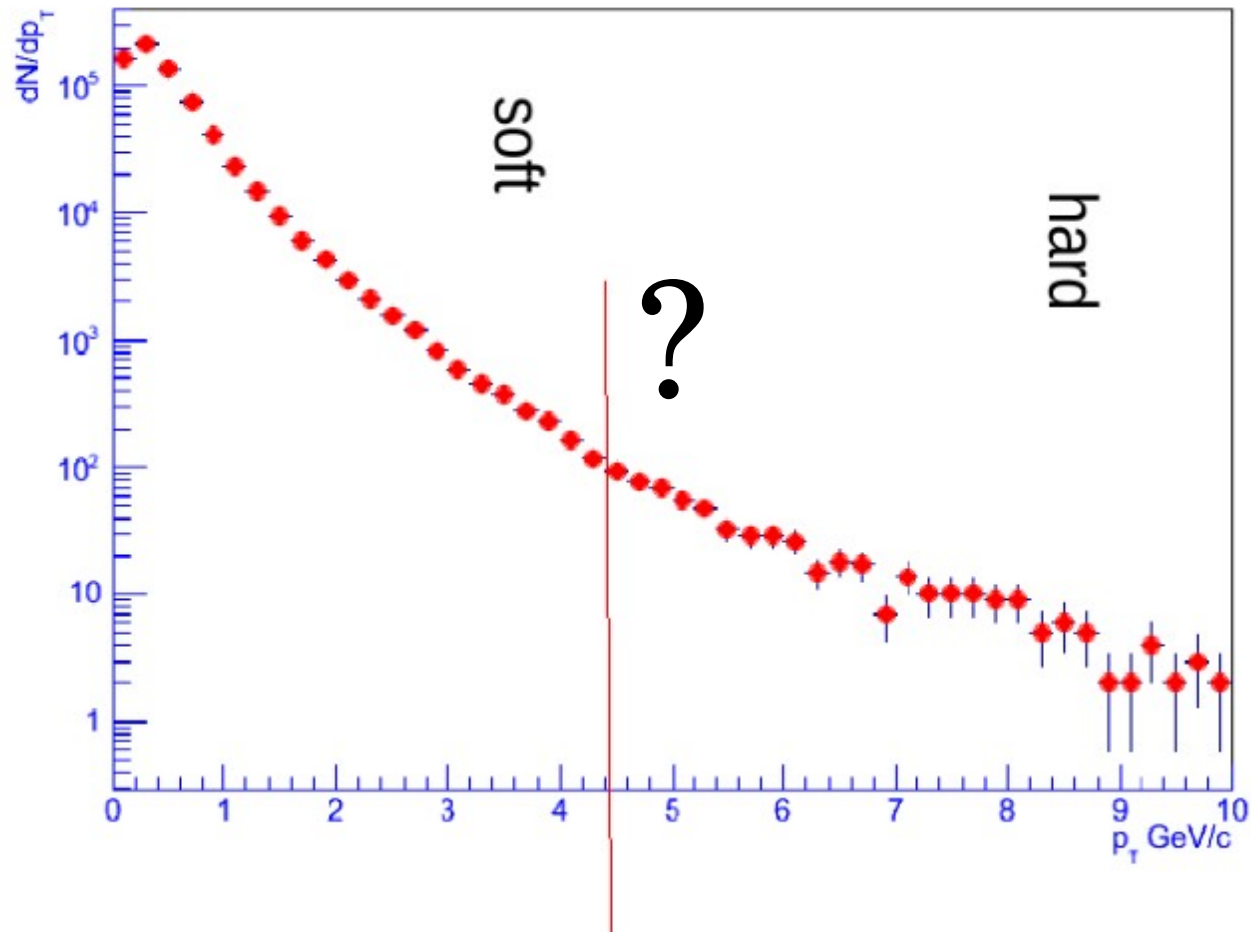

Events preselection

Pythia v.6-424

10K events $\sqrt{s} = 7$ TeV
All charged particles

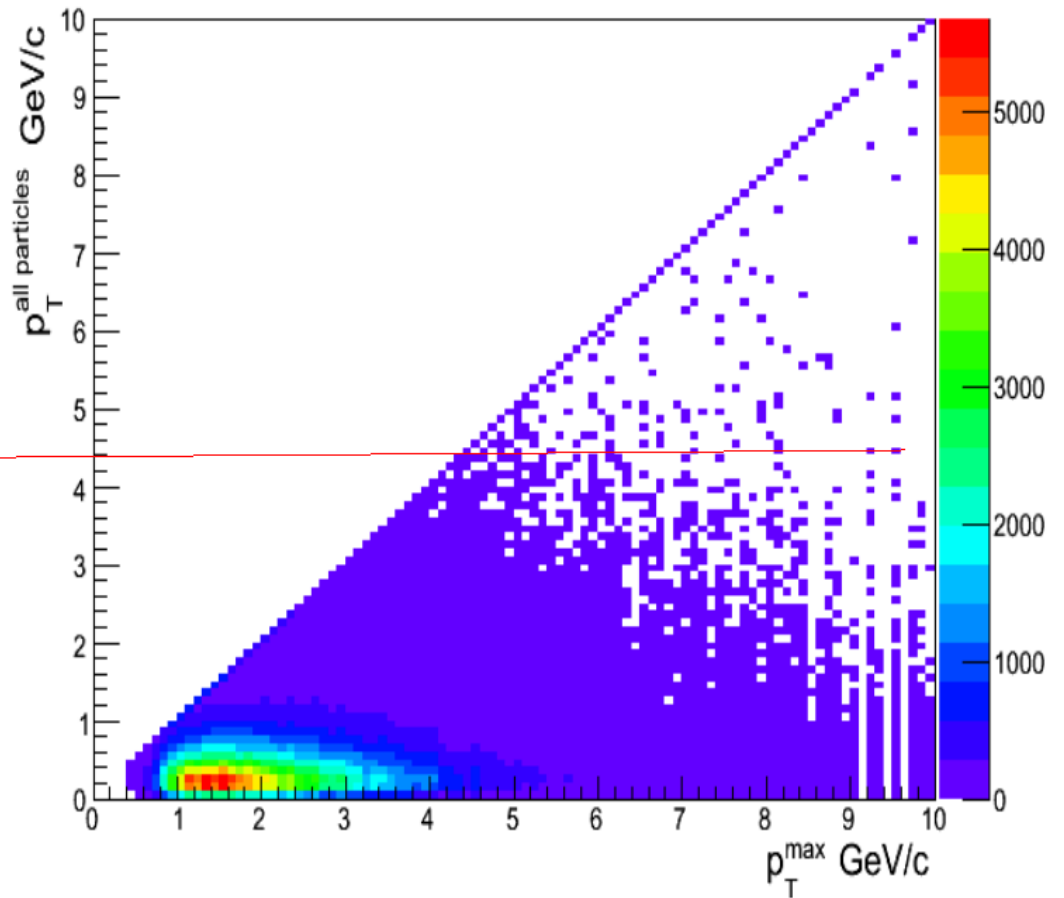
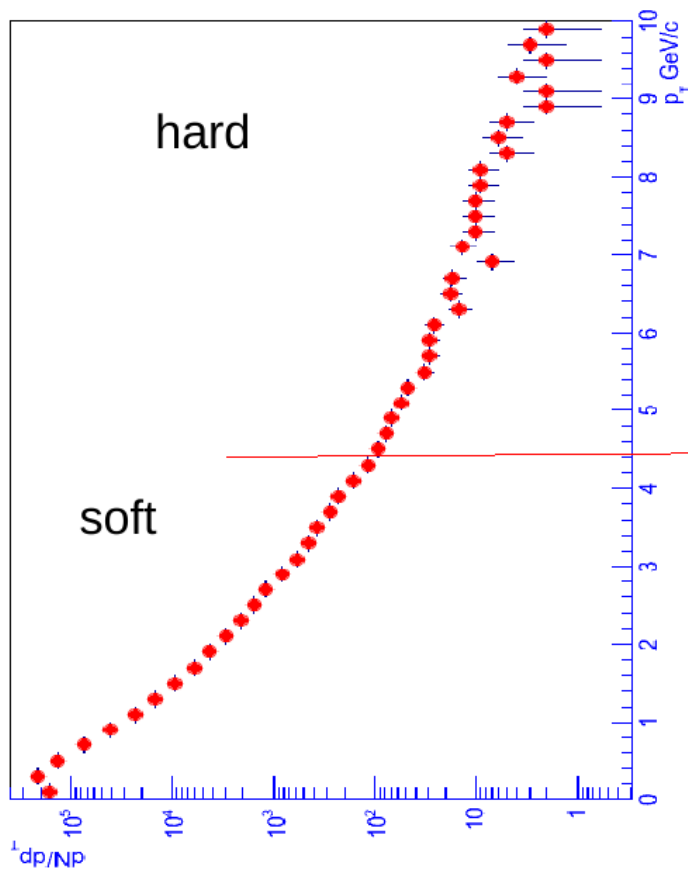

Fixed Target Program with STAR

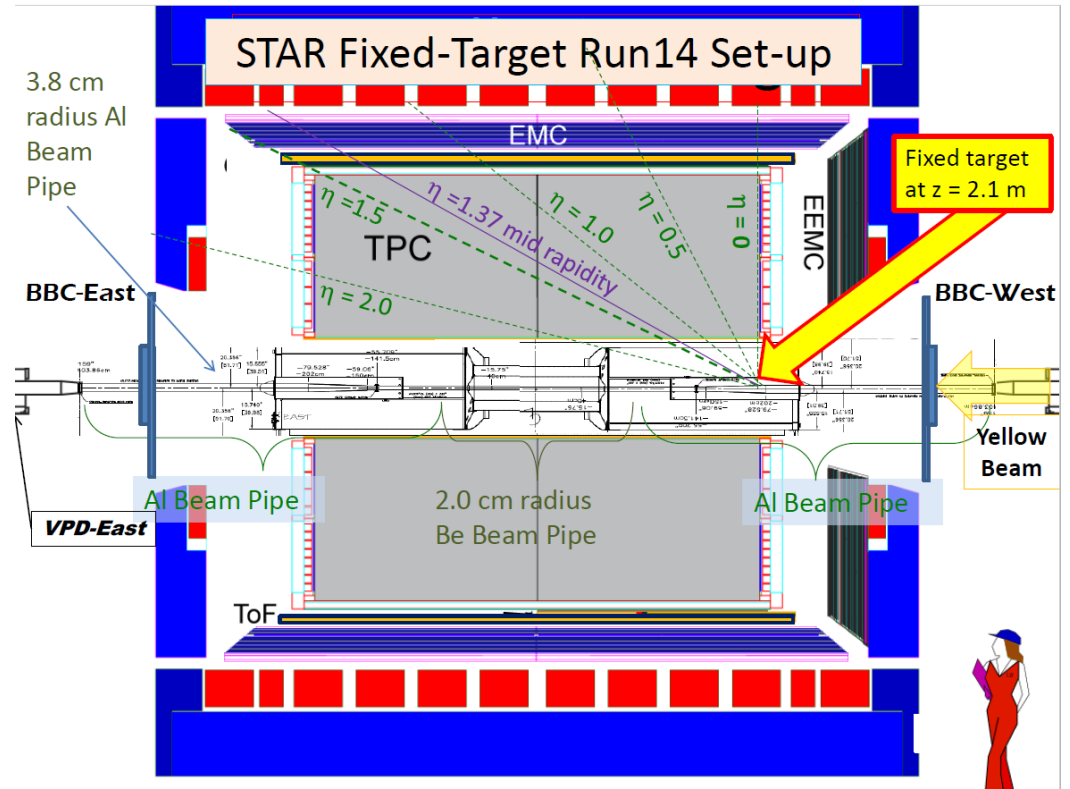
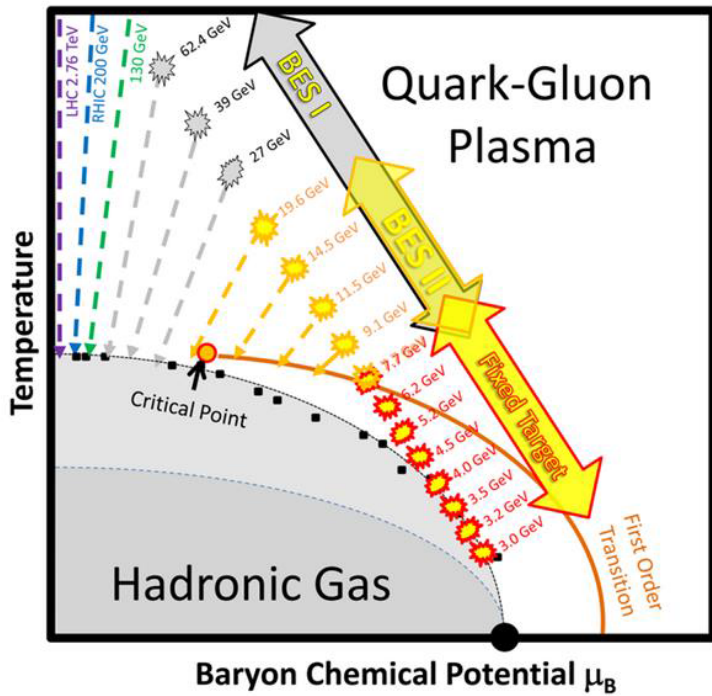

Au+Au FXT at 3.9 GeV

- Extend energy reach to overlap/complementary AGS/FAIR/JPARC
- Real collisions taken in run 14 and results (K. Meehan @ QM15 & WWND16)
- Upgrades (iTTPC+eTOF+EPD) crucial
- Unprecedented coverage and PID for Critical Point search in BES-II
- Spectra, flow, fluctuations and correlations

