

ControlSpace Designer 5.1

User Guide



Table of Contents

Table of Contents	2
Introduction	19
Welcome	19
Training, Application, and Support	19
Getting Started	20
System Requirements	20
Software Installation	20
ControlSpace Networks	26
Working With ControlSpace® Networks	26
Host Network Interface	27
Managing Device Addresses	28
Devices Using DHCP	28
Devices Using a Fixed IP Address	29
EX-1280C or Other Devices Without DHCP Server/Router	29
Hardware Manager	29
Launching the Hardware Manager	29
Device List Tabs	31
Batch Mode	35
Non-Networked PowerMatch Devices	36
Connecting to Devices	38
Connection Methods	38
Cabling and PC Configurations	38
Adding Devices to an Existing Network	39
Using USB	40
Direct Ethernet	40
Auto-MDIX Ethernet ports	40
Ethernet cables	41
Device Connection Status	41
Network Scan	41
Error Messages	42
Setting Device IP Addresses	43
Connecting to a System	44
Empty Project View	44
Project View Populated from a Network Scan	45
Project View Populated With Devices from a ControlSpace Project File	47
Disconnecting From the System	49
Dante Digital Audio Networks	51
Dante™ Network Audio	51
Basic Dante Network	51

Combined Digital Audio and Control Network	51
Dynamic Routing for Dante Networks	52
Enabling Dynamic Routing	52
Setting the Dante Routing Used for Power-On	53
User Interface	56
Interface Overview	56
Windows Reference	57
Design Workspace	57
Device Tab and Signal Processing View	57
SP Tool Kit	58
Wiring Between SP Blocks	59
Renaming a Device or Signal Processing Block	59
Device List	59
Control Library	61
Control Library Functions	61
Parameter Sets Window	63
Parameter Set Lists Window	65
Groups Window	66
RCGroups Window	67
Timers Window	68
Project Directory	70
Properties Window	74
Window Controls	78
Floating Windows	78
Docking Windows	79
Minimizing Docked Windows	80
Menus Reference	81
File Menu	81
Edit Menu	84
View Menu	85
Tools Menu	87
System Menu	90
Window Menu	92
Help Menu	93
Configuring Devices	94
Building a Project File	94
Project Files	94
Adding Devices	94
Other Device Block and Wiring Operations	95
Adding Design Notes	95
Adding Project Information	98

Accessing Signal Processing View	99
Block-Handling Functions	103
Renaming Single Blocks or Devices	103
Renaming Multiple Blocks or Devices Using Wildcards	104
Setting Port Spacing	105
Copy Parameters	106
Wiring Operations	107
Single Wire Connections	107
Multiple Wire Connections	108
Fan-Out Wire Connections	109
Routing Control of Orthogonal Wires	110
Wire Connection Labels	110
Wire Connection Color	111
Audio Routes	111
Engineered Sound Processors (ESPs)	112
Engineered Sound Processor (ESP) Devices	112
ESP-00 II Processor	113
ESP-00 II Device Properties	113
ESP-00 II Audio Card Control Panels	115
4ch Mic/Line Input II	115
4ch Line Output II	116
4x4 Mic/Line Input/Output Card	117
Input Control Panel	117
Output Control Panel	118
4ch EDR Input Card	118
4ch EDR Output Card	119
8ch AES3 Input Card	120
8ch AES3 Output Card	121
4ch Mic/Line Input Card	122
4ch SDR Output Card	123
Surround Sound	124
Surround Sound Decoder Input Card	124
Surround Sound Decoder	129
Background	129
Surround sound system types	130
Positioning surround sound loudspeakers	130
Signal Processing Considerations	133
CobraNet Input/Output Card	133
Defining the CobraNet® Input/Output Card Configuration	134
CobraNet Properties	135
8ch ESPLink Output Card	138

Dante™ Network Card	139
Defining the Dante™ Card Configuration	139
Dante Network Card Input/Output Control	140
ESP-00 II GPIO	142
GP In Control Panel	142
GP Out Control Panel	143
ESP-00 II Serial Input/Outputs	144
Serial Input	144
Serial Output	145
ESP-880/1240/4120/1600 Processors	146
ESP-880/1240/4120/1600 Device Properties	146
ESP-880/1240/4120/1600 Input Controls	147
ESP-880/1240/4120/1600 Output Controls	148
ESP-880/1240/4120/1600 ESPLink Output Controls	148
ESP-880/1240/4120/1600 GPIO	149
GP In Control Panel	150
GP Out Control Panel	151
ESP-880/1240/4120/1600 Serial Input/Outputs	152
Serial Input Control Panel	153
Serial Output Control Panel	154
Expansion Cards	155
Dante™ Network Card	155
Defining the Dante™ Card Configuration	155
Setting the Number of Channels	155
Dante Network Card Input/Output Control	157
ControlSpace® Network Control Card	158
ESP Signal Processing	158
SP Tool Kit	158
ESP Signal Processing View	159
EX-1280C Signal Processing View	160
Working With SP Blocks	160
Aligning Blocks	160
Wiring Blocks	160
Other SP Block and Wiring Operations	161
Changing Channel Counts on Blocks	161
Changing Mixer Channel Input and Output Labels	162
Supported Signal Processing Algorithms for ESP	162
AGC	162
Array EQ	163
Automatic Microphone Mixers	164
Automatic Microphone Mixer - Gated (ESPs only)	164

AMM Gated Control Panel	164
AMM - Gated Block Functional Block Diagram	167
Automatic Microphone Mixer - Gain Sharing	168
Setting the Number of Channels	168
Logic Support (EX-1280C Only)	168
Linking AMM - Gain Sharing Blocks (EX-1280C Only)	169
AMM - Gain Sharing Block Configurations	169
AMM Gain Sharing Block Control Panel	170
AMM - Gain Sharing Functional Block Diagram	173
Compressor/Limiter	173
Filters/Crossovers	175
2-way crossover	175
3-way crossover	176
4-way crossover	178
Delay	179
Ducker	179
Gain	181
Setting the Number of Ports	181
Gain Block and Control Panel	181
Gate	182
1/3 Oct Graphic EQ	183
Matrix Mixer	184
Setting the Number of Ports	184
Matrix Mixer Block and Control Panel	184
Meters	185
Variable Parametric EQs	187
Selecting the Number of Bands	187
Variable PEQ Control Panel	187
Peak RMS Limiter	190
Predictive Feedback Suppression (PFS)	191
Filters	191
Static	193
Dynamic	194
Saving & Loading VPEQ Files	194
Routers	194
Setting the Number of Ports	194
Router Block and Control Panel	195
Source Selector	195
Setting the Number of Channels	196
Source Selector Block and Control Panel	196
Speaker EQ	197

Standard Room Combining (StRC)	197
Creating & Managing StRC Blocks	197
Selecting Background Music (BGM)	200
Adjusting Volume & Muting	200
Creating & Editing a Room Layout	202
Combining Rooms	204
Speaker PEQ (Bose Speaker Parametric EQ)	205
Standard Mixer	206
Setting the Number of Ports	206
Standard Mixer Block and Control Panel	207
Test/Measurement SP Blocks	208
Tone Control EQ	209
EX-1280C Processor	210
EX-1280C Device Properties	210
EX-1280C Input/Output Controls	211
Input Control Panel	211
Output Control Panel	211
EX-1280C AmpLink Output Controls	212
EX-1280C GPIO	213
GP In Control Panel	213
GP Out Control Panel	215
EX-1280C Serial Input/Outputs	216
Serial In Control Panel	217
Serial Out Control Panel	218
EX-1280C VoIP Input/Outputs	219
VoIP In Control Panel	219
VoIP Out Control Panel	220
VoIP Dialer	220
EX-1280C Dante™ Input/Outputs	221
Setting the Number of Channels	221
Dante Input Control Panel	222
Dante Output Control Panel	222
EX-1280C PSTN Input/Outputs	223
PSTN In Control Panel	223
PSTN Out Control Panel	224
PSTN Dialer	224
EX-1280C USB Input/Outputs	225
USB In Control Panel	225
USB Out Control Panel	226
EX-1280C Signal Processing	226
SP Tool Kit	226

ESP Signal Processing View	227
EX-1280C Signal Processing View	228
Working With SP Blocks	228
Aligning Blocks	228
Wiring Blocks	228
Other SP Block and Wiring Operations	229
Changing Channel Counts on Blocks	229
Changing Mixer Channel Input and Output Labels	230
Managing VoIP	230
From CSD	230
From the Web-Based VoIP Application	232
Managing Dante Audio Routes	232
Adding Dante I/O Blocks to Set Up an Audio Route	232
Conference Room Combining and Dante Audio Routes	233
Supported Signal Processing Algorithms for EX-1280C	235
Acoustic Echo Cancellation - AEC	235
Setting the Number of Ports	235
Adding Multiple AEC References to an EX-1280C	235
AEC Blocks and Control Panel	236
AGC	237
Enhanced AGC	238
Setting the Number of Channels	238
Enhanced AGC Block and Control Panels	238
Array EQ	241
Automatic Microphone Mixers	241
Automatic Microphone Mixer - Gain Sharing	241
Setting the Number of Channels	242
Logic Support (EX-1280C Only)	242
Linking AMM - Gain Sharing Blocks (EX-1280C Only)	242
AMM - Gain Sharing Block Configurations	242
AMM Gain Sharing Block Control Panel	243
AMM - Gain Sharing Functional Block Diagram	246
Automatic Microphone Mixer - Gated (EX-1280C only)	247
Setting the Number of Channels	247
Linking AMM - Gated Blocks	248
AMM - Gated Block Configurations	248
AMM Gated Block Control Panel	249
AMM - Gated Functional Block Diagram	254
Linking AMM Blocks to Extend Channels	255
Chain Inputs & Outputs	256
Sum Inputs & Outputs	256

Mix Inputs & Outputs	257
Examples	258
Cascading 3 AMMs	258
Linking 3 AMMs for 3 Separate Zones	259
Room Combining	259
Compressor/Limiter	261
Conference Room Router	263
About Conference Room Router and Combiner	263
Conference Room Router	263
Combining Rooms	263
Configuring a Single CRR	263
Configuring Combined Rooms	265
Removing a CRR Block from an RC Group	267
CRR Block Input and Output Ports	267
CRR Input Ports	268
CRR Output Ports	269
CRR Ports in RCGroups	271
CRR Control Panels	272
Basic Control Panel for All CRR Configurations	272
Control Panel for Multiple Combined CRR Configurations	273
Room Combine Layout and Room Combine Control Panels	274
Room Combine Layout Control Panel	274
Room Labels	275
Room Layout	275
Room Combine Control Panel	277
Color Coding	278
CRR Speaker Matrix	279
CRR Functional Block Diagram and Description	280
Advanced Matrix View	282
Default Settings	283
Volume/Mute Settings	285
RC Input ON/OFF Indicators	285
Storing CRR Settings in Parameter Sets	286
Linking CRR Blocks to Automatic Mic Mixer Blocks	287
Filters/Crossovers	289
2-way crossover	289
3-way crossover	291
4-way crossover	292
Delay	293
Ducker	294
Gain	295

Setting the Number of Ports	295
Gain Block and Control Panel	296
Gate	296
1/3 Oct Graphic EQ	298
Matrix Mixer	298
Setting the Number of Ports	298
Matrix Mixer Block and Control Panel	299
Meters	300
Variable Parametric EQs	301
Selecting the Number of Bands	301
Variable PEQ Control Panel	301
Peak RMS Limiter	304
Predictive Feedback Suppression (PFS)	305
Filters	305
Static	308
Dynamic	308
Saving & Loading VPEQ Files	308
Routers	308
Setting the Number of Ports	308
Router Block and Control Panel	309
Source Selector	310
Setting the Number of Channels	310
Source Selector Block and Control Panel	310
Speaker EQ	311
Speaker PEQ (Bose Speaker Parametric EQ)	311
Standard Room Combining (StRC)	313
Creating & Managing StRC Blocks	313
Selecting Background Music (BGM)	315
Adjusting Volume & Muting	316
Creating & Editing a Room Layout	318
Combining Rooms	320
Standard Mixer	321
Setting the Number of Ports	321
Standard Mixer Block and Control Panel	321
Test/Measurement SP Blocks	322
Tone Control EQ	324
PowerMatch® 8500/8250/4500/4250	324
PowerMatch® Configurable Professional Power Amplifier Devices	324
Amplifier Properties	325
Output Configuration	327
USB Connection	330

Initial USB Connection	330
USB Device Numbering	332
Adding a Device to the Project via USB	332
Front Panel Lock Enabled	333
Closing a USB Connection	334
Signal Processing	334
Signal Processing View	334
Input Control	335
Signal Generator	336
Input Parametric EQ	337
Array EQ	338
Matrix	339
Band Pass Crossover	340
Loudspeaker Parametric EQ	341
Limiter	342
Signal Delay	343
Output Attenuation	343
PowerMatch Monitor Panels	346
Working With Alarms	349
Alarm Summary	349
Fault Output Configuration	349
Viewing the Alarm Log	350
Working with Auto-Standby	351
Measuring Loudspeaker Impedance	352
Expansion Cards	354
ESPLink 8-Channel Input Card	354
Dante™ Network Card	355
Defining the Dante™ Card Configuration	355
Channel Selection (4-Channel Models Only)	356
Configuring the PowerMatch Dante™ Card Audio Monitor Bus	356
CobraNet® Network Expansion Card	357
Configuring the PowerMatch CobraNet Card Audio Monitor Bus	359
AES3 Digital Input Card	362
AmpLink 24-Channel Input Card	364
Configuring Dante Networks	365
Dante™ Network Device Properties	365
Dante Properties Tab	366
Status Tab	366
Device Config Tab	367
Network Config Tab	368
Error Log Tab	370

Dante Network Routing	370
Matrix View	370
Drag and Drop View	371
Multicast Flows	374
NOTES on Multicast Flows	376
Configuring Dante Endpoints	377
Adding Dante Endpoints and Microphones to Project View	377
Automatic Discovery	377
Adding Dante Devices Manually	378
Device Icons/Controls for Dante Endpoints	379
EX-4ML	381
EX-8ML	382
EX-UH	383
EP22-D	383
EP40-D	383
WP22B-D	384
WP22BU-D	384
MSA12X	385
Right-Click Menu	385
Device Icons/Controls for Dante-Equipped Microphone Endpoints	386
ATND971	388
ATND8677	388
ATND8734	390
MXA310	391
MXA910	392
MXWAPT2, MXWAPT4, or MXWAPT8	392
ULXD4D	394
ULXD4Q	394
Right-Click Menu	395
Adding Dante Endpoint and Microphone Blocks to SP View	395
Dante Endpoint and Microphone SP Blocks	397
EX-4ML	397
EX-8ML	398
EX-UH	398
ATND971	398
ATND8677	399
ATND8734	399
MXA310	399
MXA910	399
MSA12X	400
MXWAPT2	400

MXWAPT4	400
MXWAPT8	400
ULXD4D	401
ULXD4Q	401
MSA12X Steerable Loudspeaker Array Dante Endpoint	401
About the MSA12X Steerable Loudspeaker Array	401
MSA12X Configuration & Main Control Panel Options	402
Acquiring Beam Configuration Data	402
MSA12X Device Block	403
MSA12X Main Control Panel	404
Storing and Recalling Beam Presets in MSA12X Arrays	407
Setting an MSA12X Array's Power-On State	409
Setting Up MSA12X Basic Beam Steering and Spreading in CSD	410
MSA12X Advanced Control Panel Options	411
Assigning MSA12X Beam Presets to Parameter Sets	414
Configuring Control Centers	416
CC-1, CC-2, CC-3 Zone Controllers	416
CC-3 Zone Controller	417
CC-16 Zone Controller	418
CC-16 Smart Simulator	419
CC-16 Zone Controller Properties	420
CC-16 Zone Controller - Monitor Mode	421
CC-64 Control Center	422
CC-64 Smart Simulator	422
CC-64 Control Center Properties	423
CC-64 Control Center - Monitor Mode	425
Controlling System Devices	426
Programming Overview	426
Control Library	426
Programming Work Space	426
Parameter Sets	427
Creating a Parameter Set	427
Renaming a Parameter Set	429
Editing Parameter Sets	429
Copy/Paste Parameter Sets	430
Adding More Parameter Sets	430
Recalling Parameter Sets	431
Clearing Parameter Sets	431
Parameter Set Nodes List	432
Storing Individual Parameters	433
Parameter Set Lists	434

Adding a Parameter Set List	434
Renaming a Parameter Set List	435
Editing a Parameter Set List	435
Recalling Parameter Sets in a List	436
Clearing & Deleting Parameter Set Lists	437
Managing Parameter Set Lists on a Control Center	437
Programming Dante Subscriptions into Parameter Sets	439
Groups	443
Creating a Group	443
Renaming a Group	447
Editing Groups	447
Adding Groups	448
Clearing Groups	448
Group Node List	449
RCGroups	450
Creating an RCGroup	450
Renaming an RCGroup	451
Editing RCGroups	451
Adding RCGroups	452
Clearing RCGroups	452
Timers	453
Creating a Timer	453
Editing a Timer	455
Renaming a Timer	455
Recalling Timers	456
Clearing Timers	456
Programming With Composite Device Blocks	457
GPIO Programming	459
Programming GPIO	459
General Purpose Inputs (GPI)	459
External Potentiometers and Switches	459
General Purpose Outputs (GPO)	460
Programming GPI	460
Analog Mode	460
Digital Mode	461
Digital Up/Down Volume Mode	462
Digital Discrete Mode	463
Programming GPO	464
Using the Project Directory	465
Using the Parameter Set Nodes List	465
Serial Port Programming	466

Serial Inputs	466
Serial Outputs	467
Using the Project Directory	468
Using the Parameter Set Node List	469
Logic Programming (EX-1280C only)	469
About Logic	469
Types of Logic Blocks	470
Logic Symbols	470
Adding Pre-Defined Logic Blocks	471
Adding Custom Logic Blocks	472
Showing or Hiding Logic Connections	475
For a Block	475
For a Design	475
Simulating Logic Offline	476
Logic Operators/Functions and Predefined Logic Blocks	477
AND Operator	477
OR Operator	477
XOR Operator	478
NAND Operator	478
NOR Operator	478
NXOR Operator	478
NOT Operator	478
ONEHOT Operator	478
OR_ALL Operator	479
AND_ALL Operator	479
FLIPFLOP Operator	479
TOGGLE Operator	479
TOGGLE/FF Operator	480
Global Logic Inputs - S and R	480
PULSE Operator	480
Standard Mode	481
Single Pulse Mode	481
Force On Mode	481
DEBOUNCE Operator	481
LATCH ALL Predefined Block	482
LATCH + GLOBAL Predefined Block	482
Global Logic Input	482
LED SPLIT Predefined Block	482
TOGGLE/FF Predefined Block	484
Global Logic Inputs - S and R	484
Logic Routes	485

Logic and Testing Support for SP Blocks	487
Default Logic Operation	487
Inverted Logic Operation	490
Logic Testing Support	491
General Purpose I/O Block Logic Support	491
GP In Block Logic	492
GP Out Block Logic	492
Serial I/O Block Logic Support	492
Serial In Block Logic	492
Serial Out Block Logic	492
Logic Input Block	492
Setting the Number of Outputs	493
Logic Input Block and Control Panel	494
Configuring a Logic Input Block	494
Logic Output Block	496
Setting the Number of Inputs	497
Logic Output Block and Control Panel	498
Dante Endpoint and Microphone GP I/O Logic Support	498
Dante Microphone GP In Block	498
Dante Endpoint GP In Block	498
Dante Microphone GP Out Block	498
Dante Endpoint GP Out Block	499
Parameter Set Recall Block Logic Support	499
Setting the Number of Inputs	499
Control Panel	499
Control Centers	500
Control Center Programming	500
Programming CC-1, CC-2, and CC-3 Zone Controllers	500
CC-1 Controller	501
CC-2 Controller	501
CC-3 Controller	502
Programming CC-16 Zone Controllers	503
Locking the CC-16	504
Programming CC-64 Control Centers	505
Changing the Selector Order	509
Custom Settings	511
Locking the CC-64	512
Dynamic Controller Programming with Parameter Sets	514
Monitor Mode	514
Estimating DSP Usage	515
Maintaining Your System	517

Protecting System Settings	517
Protecting a Project (.CSP) File	517
Saving Password-Protected Project Files	517
Uploading Password-Protected Project Files	518
Downloading Password-Protected Project Files	518
Uploading New Project Files To Protected Systems	518
Changing or Disabling Passwords in Protected Project Files	518
Retrieving System Configurations	518
Retrieving a Saved Project File	519
Saving a Retrieved Configuration to File	519
Updating Firmware in Bose® Devices	522
Loudspeaker EQ updates (PowerMatch only)	522
Determining Current Loudspeaker EQ Database Version	522
Updating the Loudspeaker EQ Database	523
File Types	523
Appendix	525
ControlSpace Networks - Advanced Operations	525
Remote Network Control	525
Router to Router connection	525
Example Setup:	525
Remote Mode	526
Connecting With Remote Devices	527
Remote Network Connection with Design File	528
Using VPNs	529
Make sure PCs on both sides can access the Internet	529
Configuring a PPTP Server on a TP-LINK router	529
Configuring a PPTP client on remote PC (Windows 7)	533
Configure ControlSpace Designer Software	538
VPN Site-to-Site Example	540
Configure Router 1	541
Configure Router 2	543
Connect WAN ports of Router 1 and 2 to the NETGEAR switch to simulate WAN	544
Confirm that the PC on Router 1 can communicate with devices on Router 2	545
CobraNet Digital Audio Networks	547
CobraNet® Network Audio	547
CobraNet® Network Audio Routing	549
Example 1 - audio distribution between multiple processors.	550
Example 2 - audio distribution to a remote amplifier rack.	551
CobraNet Network Status	552
CobraNet Examples	553
CobraNet® Application Examples	553

Example #1: ESP-to-ESP Signal Routing554
Example #2: ESP-to-Multiple PowerMatch® Amplifiers 559

Introduction

Welcome

Welcome to ControlSpace® Designer™ software, used for the set up, configuration and control of Bose® Professional system electronics. ControlSpace Designer software simplifies system configuration and programming through the use of standard drag and drop programming methods, and Smart Simulation, which allows you to instantly preview system programming without being connected to system hardware.

Click [here](#) to get started with the ControlSpace Designer help system.

Training, Application, and Support

Additional information on the design, configuration, and control of systems using Bose Professional electronics, and the ControlSpace® Designer™ software can be found at pro.Bose.com.

The most recent application guides are always available at pro.Bose.com.

The ControlSpace User's Forum is a private forum for ControlSpace Users to share with other users, request new product features and functions, report issues with both software and hardware, and interact with the product development team. To join the ControlSpace User's forum go to proforum.Bose.com.

Getting Started

System Requirements

The following are the minimum system requirements for ControlSpace Designer.

- Microsoft Windows® 7 or greater, x86 and x86-64bit versions (Windows 8 requires installation of Microsoft .NET 3.5)
- 1GHz processor (or better)
- 512MB of available RAM (1GB recommended)
- 512MB of available disk space (1GB recommended)
- Minimum resolution of 1366x768 WXGA
- One available USB port
- One available network port (Wired LAN, Ethernet, 100 Mb minimum; or wireless LAN 802.11g/n)

Software Installation

The following redistributable software packages are required to properly run ControlSpace® Designer™ software. These files are included with the software installation package.

- Microsoft® .NET™ Framework v4.5:
(<http://www.microsoft.com/en-us/download/details.aspx?id=30653>)
- Microsoft® Visual C++ Redistributable Packages for Visual Studio 2013:
(<http://www.microsoft.com/en-us/download/details.aspx?id=40784>)
 1. Double-click on Setup.exe to install ControlSpace Designer software.

The Welcome dialog opens:

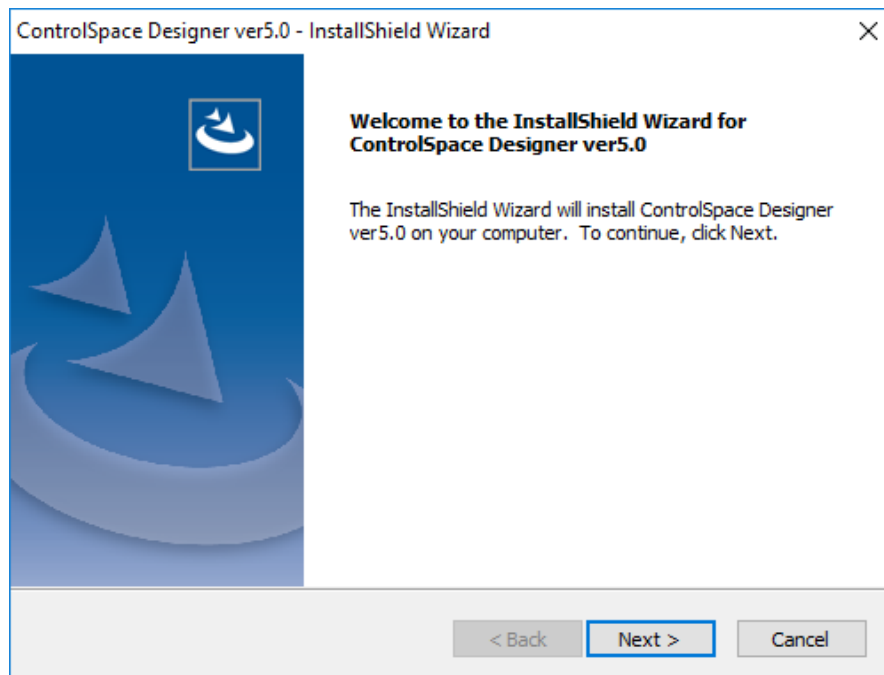

2. Click **Next** to begin installation.

The License Agreement dialog opens:

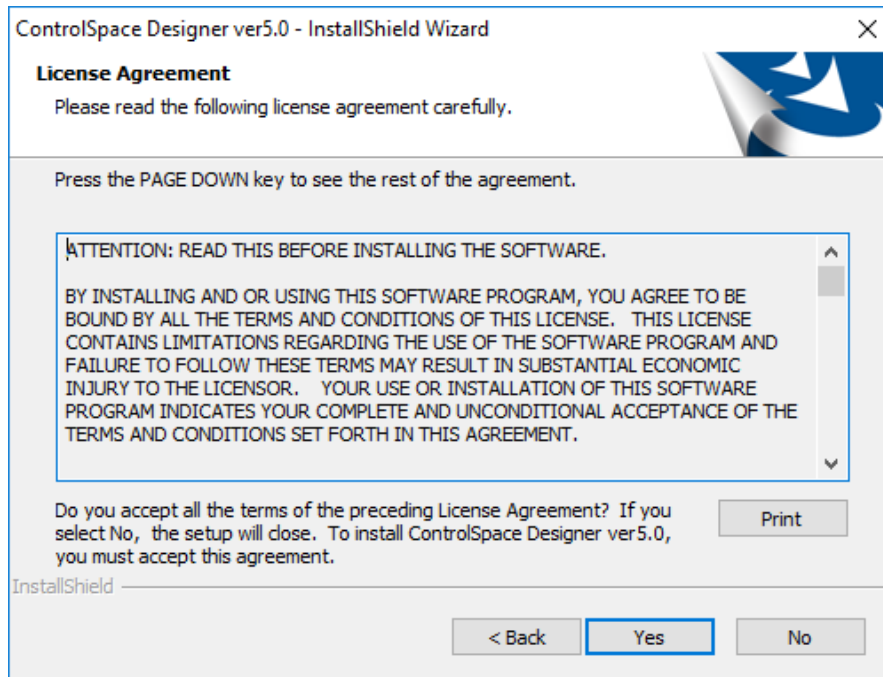

3. Read or print the License Agreement. Click the **Yes** button to continue.
4. Enter your name and company name in the Customer Information dialog and click **Next**.

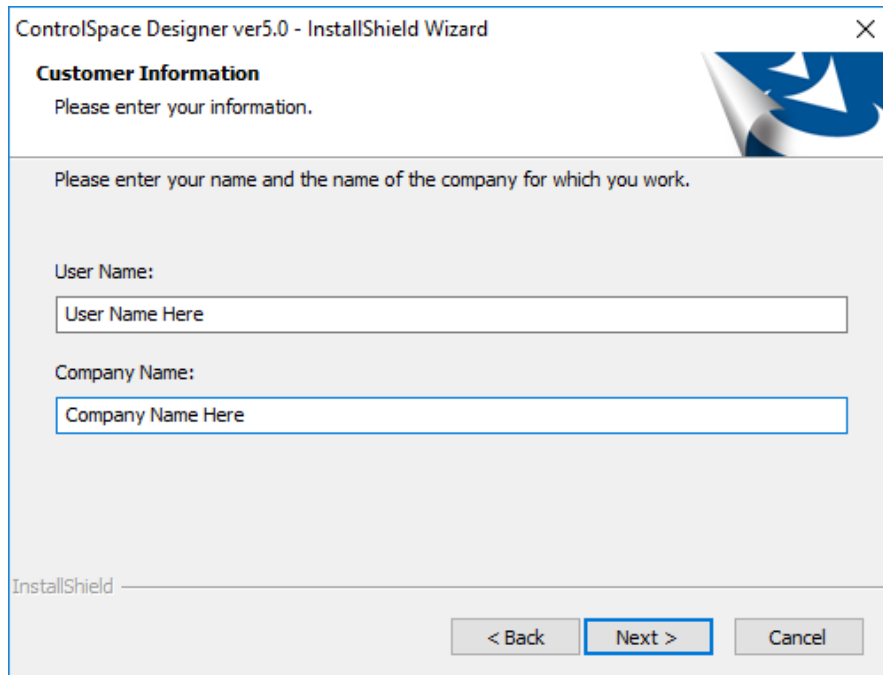

5. Select a folder for installing the software files and click **Next**.

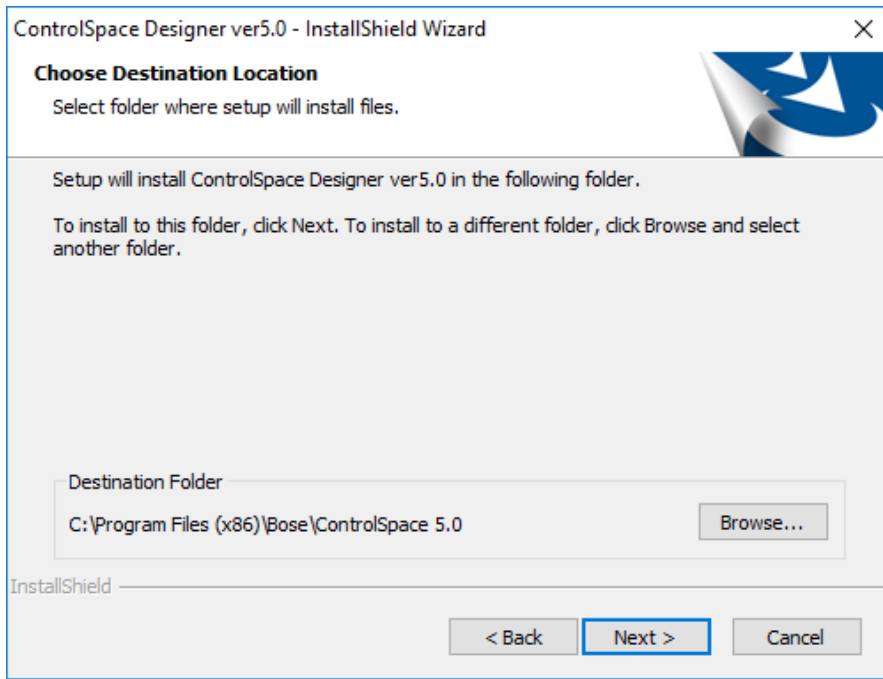

Software installation begins:

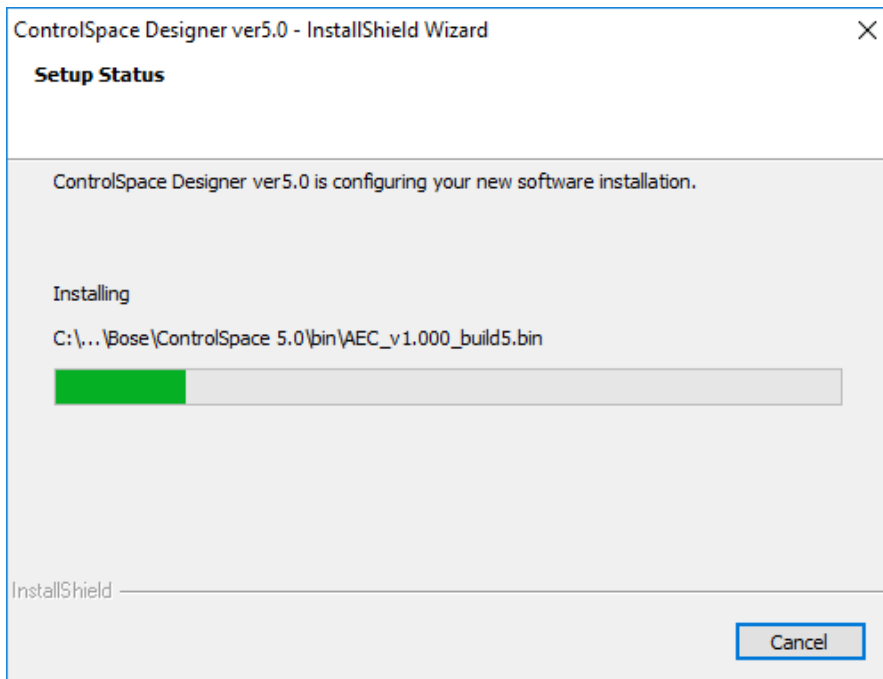

6. When prompted, specify what types of shortcuts to install.

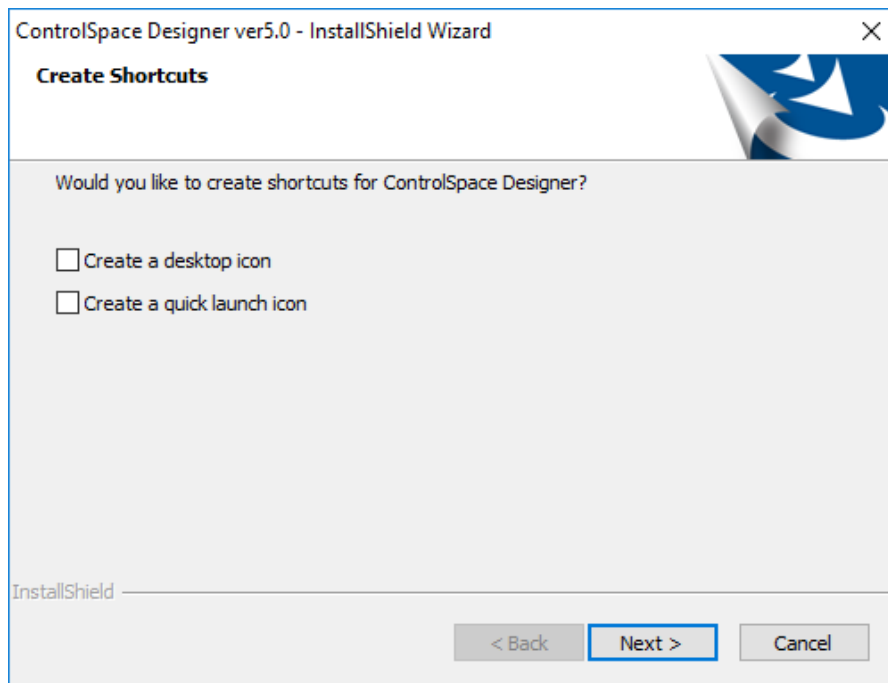

7. After shortcuts are installed, you may see the following screens. If so, click **Install** in Windows Security dialog to continue. If not, skip this step.

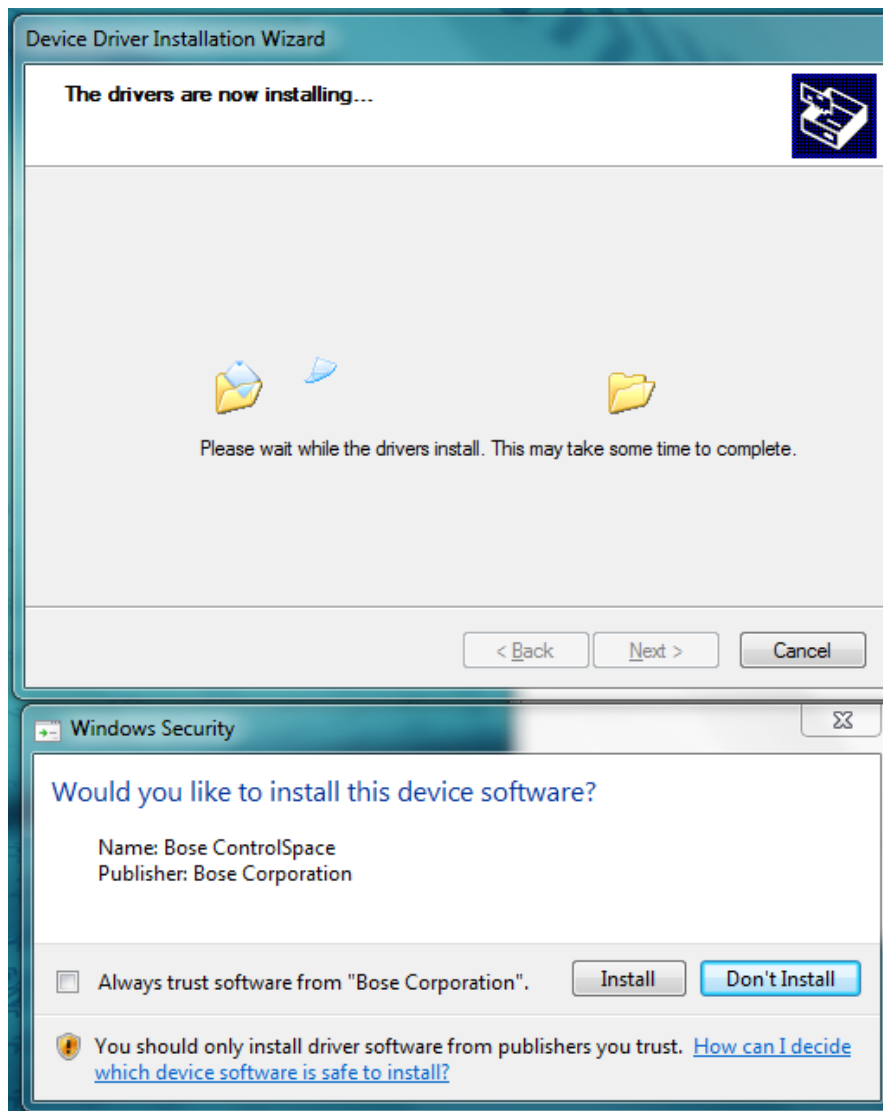

8. If the Device Driver Installation Wizard opens, click **Next** to install the drivers.

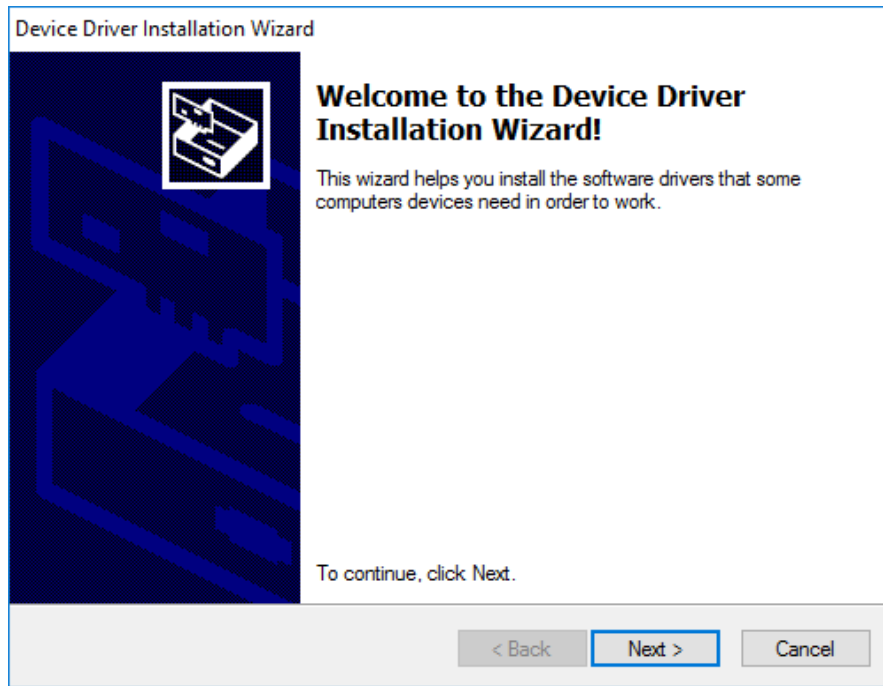

9. Click **Finish** to complete the ControlSpace Designer software installation.

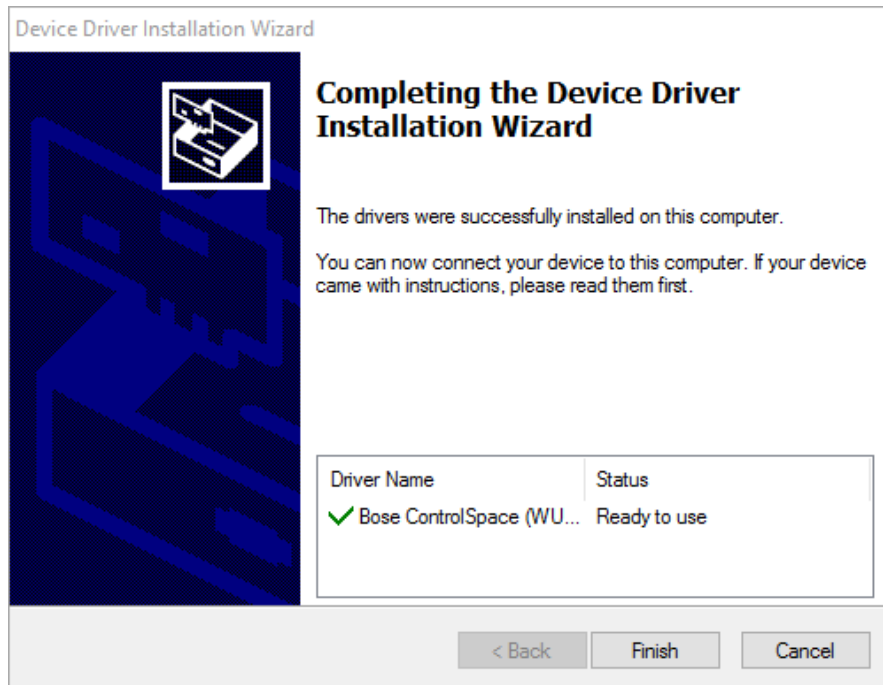

10. When the Dante support dialog opens, click the check box confirming that you agree with the license terms and click **Install**.

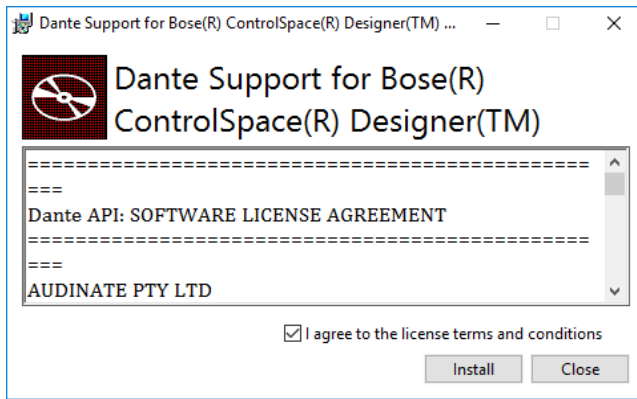

11. When the Setup Successful message appears, click **Close**.

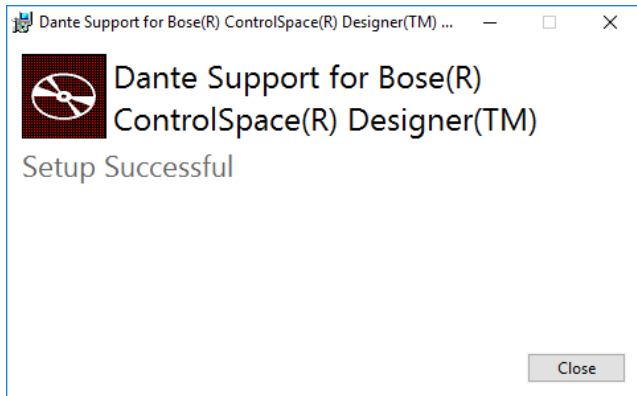

12. Click **Finish** to close the installation wizard.

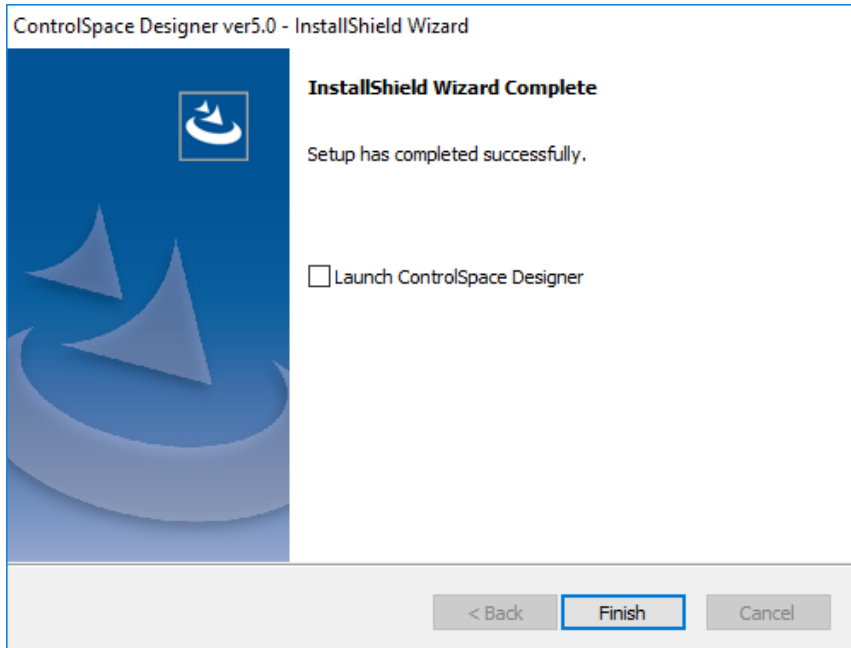

ControlSpace Networks

Working With ControlSpace® Networks

All ControlSpace® sound processors, networked user interfaces, PowerMatch® professional amplifiers, and the ControlSpace Designer™ software are pre-configured to operate on the same Ethernet network using

standard Internet Protocol (IP) addressing. The addressing of devices within a design is managed automatically according to the currently defined Project Network Address and the type of device.

By default, the Project Network Address is set to 192.168.0 with a subnet mask of /24, or 255.255.255.0. When connecting to the network, the ControlSpace Designer (CSD) Network Interface Card (NIC) is selected automatically unless you specifically selected one after the CSD software was installed. Normally, the NIC is set up on your computer to match the default project mask and address in the expected range, for example 192.168.0.10, and connect to devices via that NIC.

When connecting to a device for the first time you will need to set your PC's IP address to 192.168.0.xx, and verify that ControlSpace Designer software is using the 192.168.0.xx Project Network Address. Once this is done you can easily connect to any new ControlSpace Network devices (EX-1280C and ESP sound processors, CC-64s and PowerMatch amplifiers) and configure them for operation.

Host Network Interface

The Dante Network audio subsystem requires a NIC name at launch so that, if no NIC is specified, the name of a NIC that matches the project address and mask is automatically used.

If a wireless NIC or multiple NICs also reside on the computer, but are not intended to be used, they may interfere with network communication if communications are routed through that NIC instead of the intended NIC. In this case you must explicitly select the intended NIC in the Host NIC Setup dialog via the System menu. Once selected, the NIC is saved with the CSD installation, retained, and reused across CSD sessions.

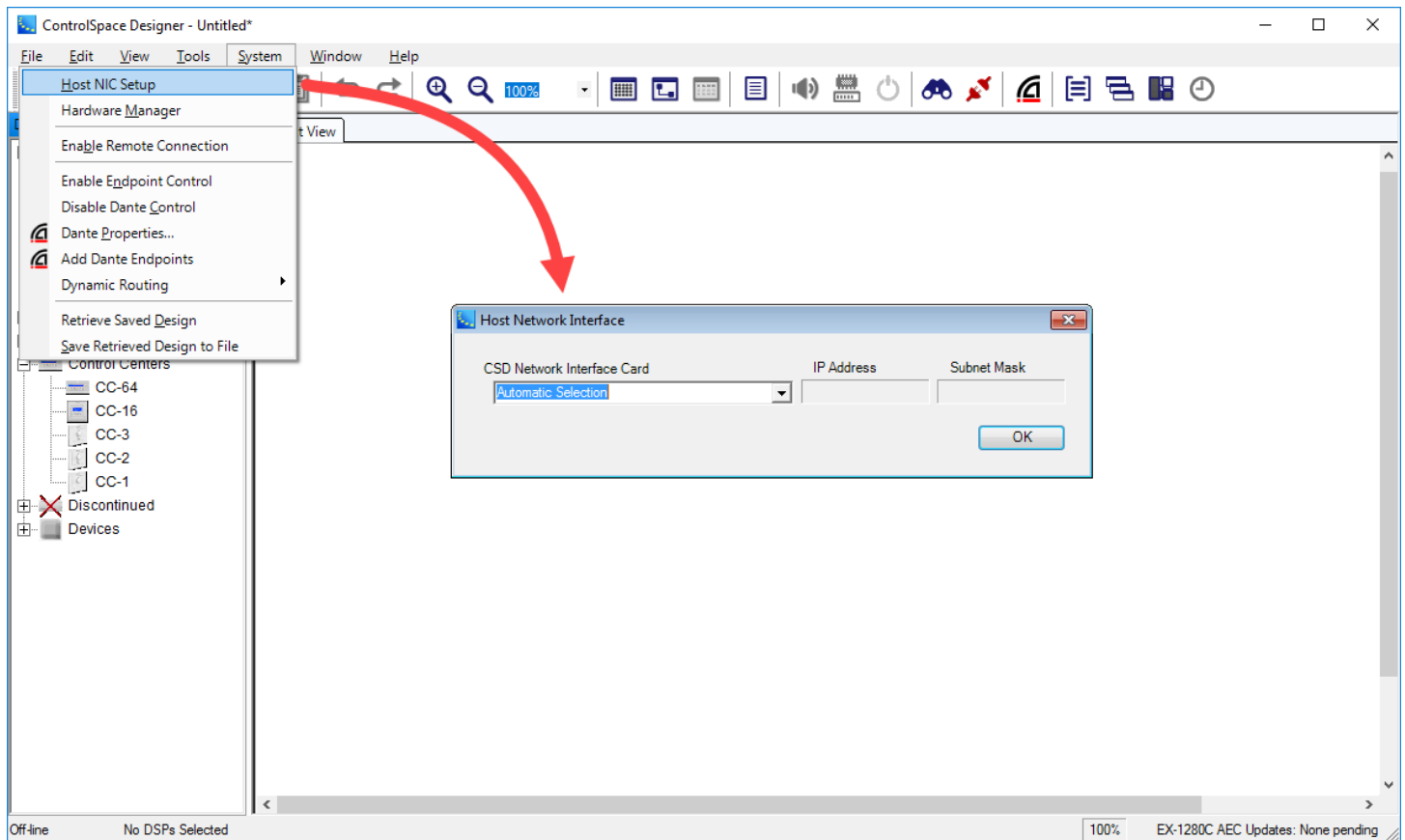

Opening the Host Network Interface dialog

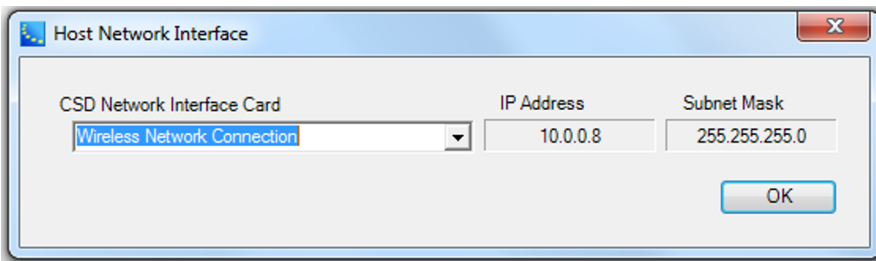

Identifying the project NIC

When a NIC is selected, it is always saved to the Settings.xml file and restored on every CSD launch. The selected NIC is used for all communications to the network. In the case where no NIC has been selected since installation of CSD, the NIC is selected automatically to match the project address. When selected, project devices are unaffected as the NIC is independent from the Project Network Address.

Managing Device Addresses

Bose network electronics ship with one of these default device address schemes:

- DHCP assigned - IP address of device is assigned by DHCP server (or Auto IP for some devices if no DHCP server)
- Fixed IP address - Static IP address, manually assigned

The table below summarizes the default IP address scheme used for each type of device.

Device IP Addresses

Device	DHCP Assigned or Default Fixed IP Address	Address Range
ESP-00 II	Fixed IP: 192.168.0.160	160-175
ESP-880/1240/4120/1600 & EX-1280C	DHCP assigned Note: EX-1280C uses an Auto IP address if no DHCP server.	N/A
PM8500N/PM8250N PM4500/PM4250N	DHCP assigned	N/A
CC-64	Fixed IP: 192.168.0.176	176-207
System PC	DHCP assigned (or Auto IP if no DHCP server)	N/A
Dante Endpoints	DHCP assigned (or Auto IP if no DHCP server)	N/A

As new devices are added to a design they are automatically given an IP address according to their device type and the currently defined Project Network Address. As additional devices of the same type are added the device address octet is incremented to prevent duplicate IP addresses being added to the design.

NOTE: It is not necessary to have a project open within ControlSpace Designer to change IP addresses. However, the address you assign to the devices should be consistent with the addresses in your design.

Devices Using DHCP

Most ControlSpace devices ship by default in DHCP mode, which facilitates automatic IP address assignment when commissioning a system. However, once the design of the system is finalized, it is recommended that you assign a fixed IP address to each device.

Devices Using a Fixed IP Address

If you are using more than one of any type of device on the network with a fixed IP address, you will need to set the IP address for each of those devices on the network individually using the Network Setup function within ControlSpace[®] Designer[™] software. The fixed IP addresses must fall within the address range shown in the table.

EX-1280C or Other Devices Without DHCP Server/Router

If the EX-1280C is deployed in a network *without* a DHCP server or router, it will default to link local mode (Auto IP) with an IP address in the range of 169.254.x.x. If other devices, including but not limited to Dante endpoints, are deployed in the same DHCP-less network, they will also default to link local mode with an address in the same space.

A link local address is a network address that is valid only for communications within the network segment (link) or the broadcast domain that the host is connected to. Link local addresses are not guaranteed to be unique beyond a single network segment. Routers therefore do not forward packets with link local addresses.

NOTE: Normally in networks without DHCP, the network and other addresses in Project Settings in the Hardware Manager should automatically populate with those in the link local address space. However, if they do not, you will not be able to add or see devices in Project View in CSD. In this case, you must update the Project Settings in Hardware Manager manually to reflect the link local address space. Once the design of your system is finalized, it is recommended that you assign a fixed IP address to each device.

Hardware Manager

Launching the Hardware Manager

The Hardware Manager dialogs are used to set the project network properties, to set device network properties, and to upload EQ files to Power Match devices. To launch the Hardware Manager, select **Hardware Manager** in the **System** menu.

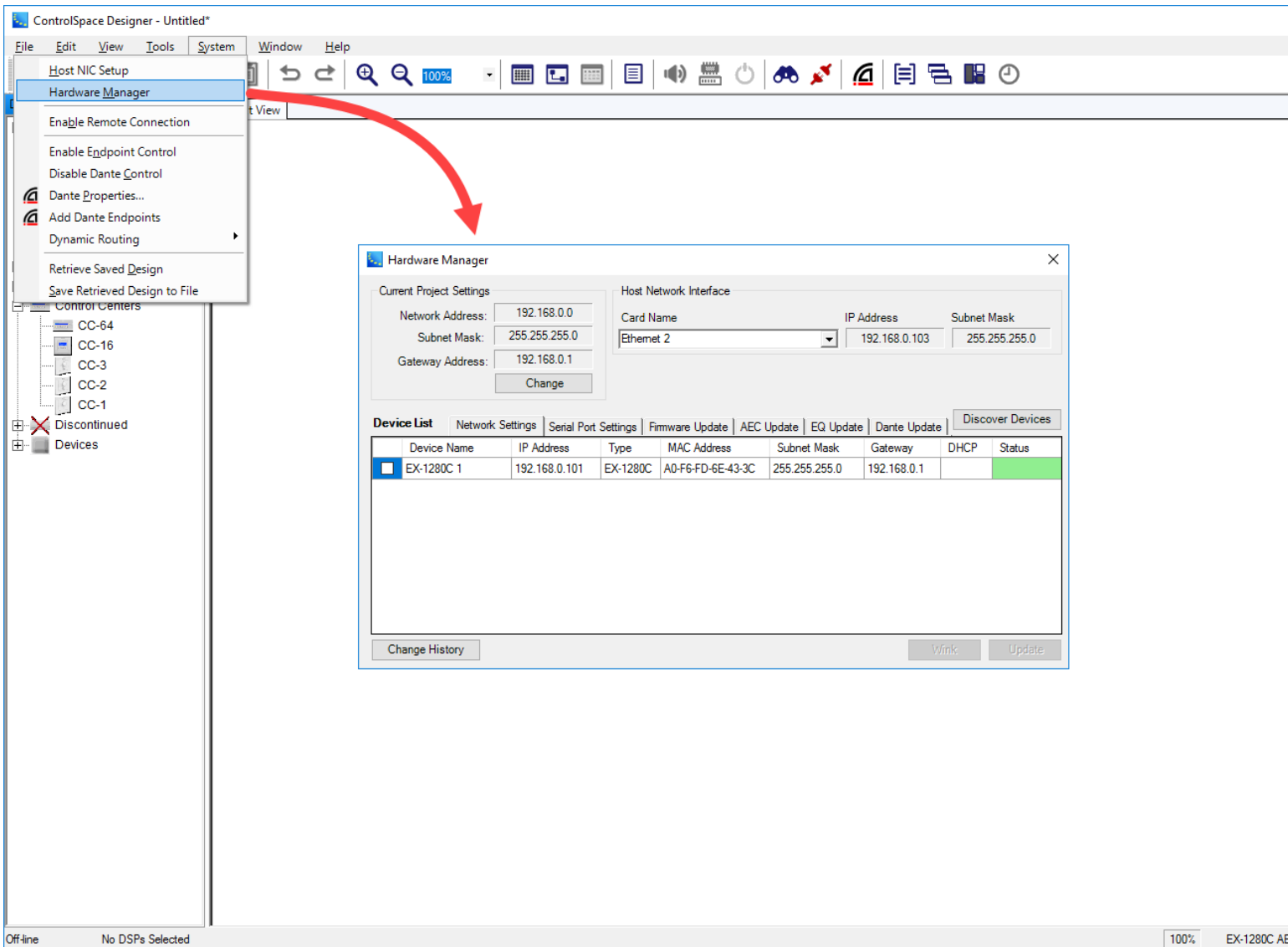

Upon launch of the dialog, a scan is performed to discover devices that answer the Broadcast scan, and are within the project network.

NOTE: When launching the Hardware Manager, the Dante network polling is suspended, as is consistent with previous behavior when launching Network Setup or Firmware Update. This means that any Dante endpoints will vanish from the project view until Dante communication is reestablished.

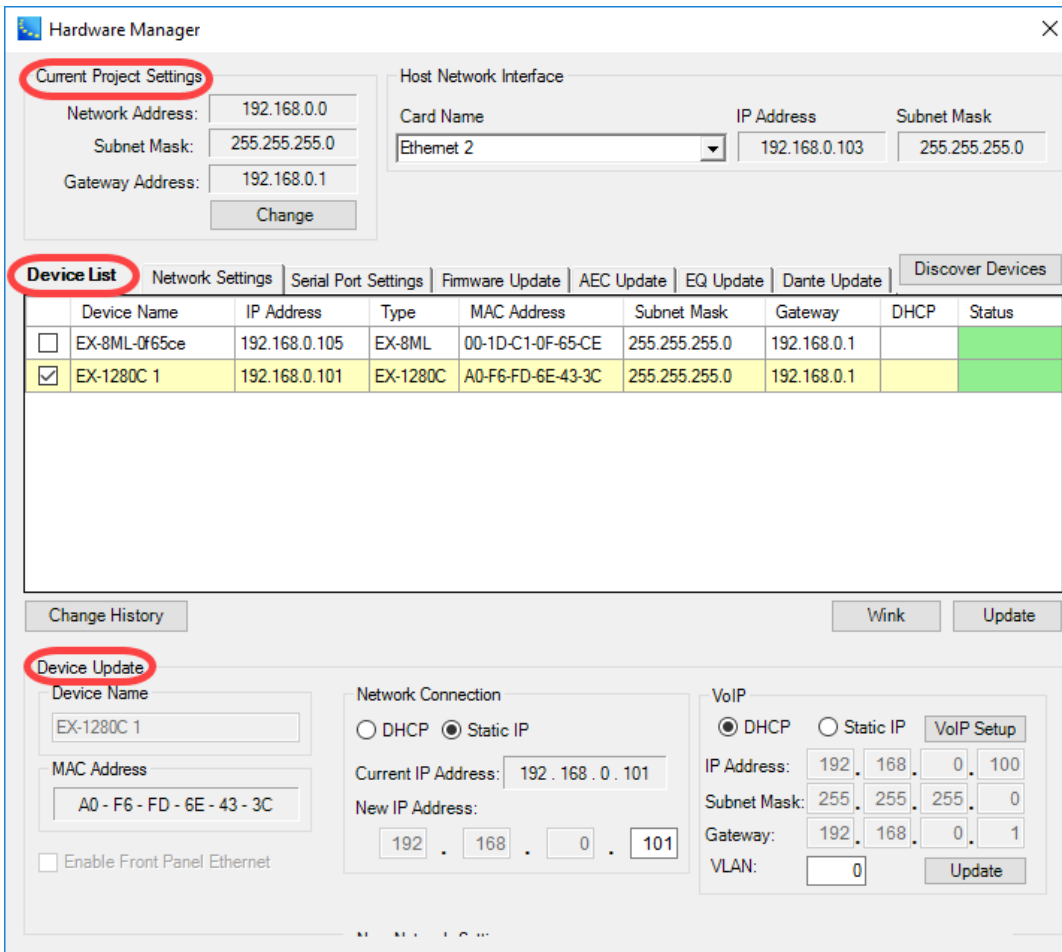

Three sections of Hardware Manager window

The Hardware Manager comprises three stacked sections of data.

Current Project Settings - The top section displays the project network address, subnet mask, and gateway address. For convenience, the current NIC settings are also displayed for comparison.

Device List - The middle section contains the list of devices that are discovered on the project network, and is always visible. The tabs included in this list are: Network Settings, Serial Port Settings, Firmware Update, AEC Update, EQ Update, and Dante Update. For convenience, the **Discover Devices** button allows you to rescan when needed, which is useful when confirming changes to hardware device properties or discovering devices that have been connected after launching the dialog. PowerMatch® non-networked devices are not included in the list.

Device Update - The lowest section is used to set device properties, but is only displayed for the Network Settings and Serial Port Settings tab when a single item is selected in the device list that has properties you can modify.

Device List Tabs

The **Device List** contains multiple tabs, including Network Settings, Serial Port Settings, EQ Update, Firmware Update, AEC Update, and Dante Update. A **Wink** button and an **Update** button are included to identify a device and change device properties, respectively. **Wink** is only enabled when a single device is selected that supports that function, including ESPs, EX-1280C, and PowerMatch® amplifiers.

In the following view, one device within the **Serial Port Settings** tab has been selected. Its serial information is shown in the Device Update section of the dialog. Note that only ESP or EX-1280C devices support serial communication and can be selected.

The screenshot shows the Hardware Manager dialog box with the following sections:

- Current Project Settings:** Network Address: 192.168.0.0, Subnet Mask: 255.255.255.0, Gateway Address: 192.168.0.1, and a Change button.
- Host Network Interface:** Card Name: Ethernet 2, IP Address: 192.168.0.103, Subnet Mask: 255.255.255.0.
- Device List:** A table with columns: Device Name, IP Address, Type, Baud Rate, Bit Length, Parity. The table contains two rows:

	Device Name	IP Address	Type	Baud Rate	Bit Length	Parity
<input type="checkbox"/>	EX-8ML-0f65ce	192.168.0.105	EX-8ML			
<input checked="" type="checkbox"/>	EX-1280C 1	192.168.0.101	EX-1280C	115200	8	None
- Buttons:** Discover Devices, Change History, Wink, Update.
- Device Update:** Serial Port Settings section with Baud Rate: 115200, Bit Length: 8, and Parity: None.

Serial Port Settings Example

Baud rate, bit length, and parity are all configurable for the serial port on ESPs or EX-1280C processors. Selecting the **Firmware Update** tab displays the Loaded Version, Latest Version, and Status for the listed devices. This view supports multi-select, and automatically selects all devices with out-of-date firmware files (highlighted in pink). Clicking the **Update** button sequentially sends a new firmware file to the selected devices. You may be asked to reboot the device or devices after new firmware is installed. Upon completion, the status column is modified accordingly.

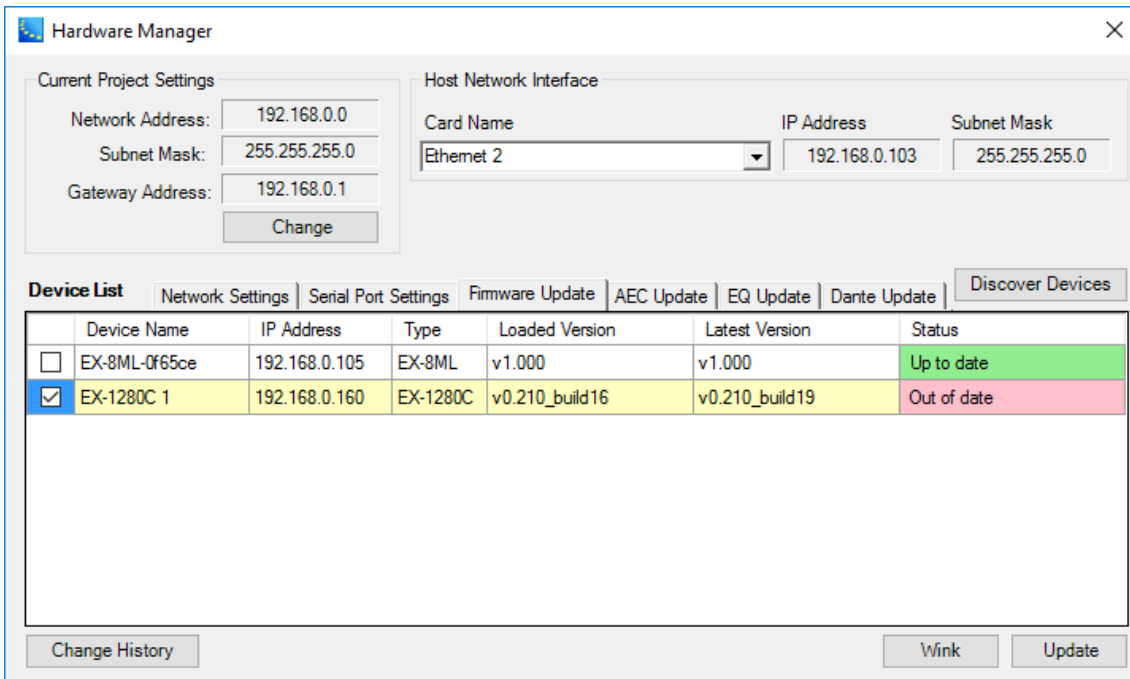

Firmware Update Tab Example

Selecting the **AEC Update** tab displays the Loaded Version, Expected Version, and Status of AEC card firmware for the listed devices. This view supports multi-select, and automatically selects all devices with out-of-date AEC firmware files (highlighted in pink). Clicking the **Update** button sequentially sends a new AEC firmware file to the selected devices. You may be asked to reboot the device or devices after the AEC card is re-flashed with the new firmware. Upon completion, the status column is modified accordingly.

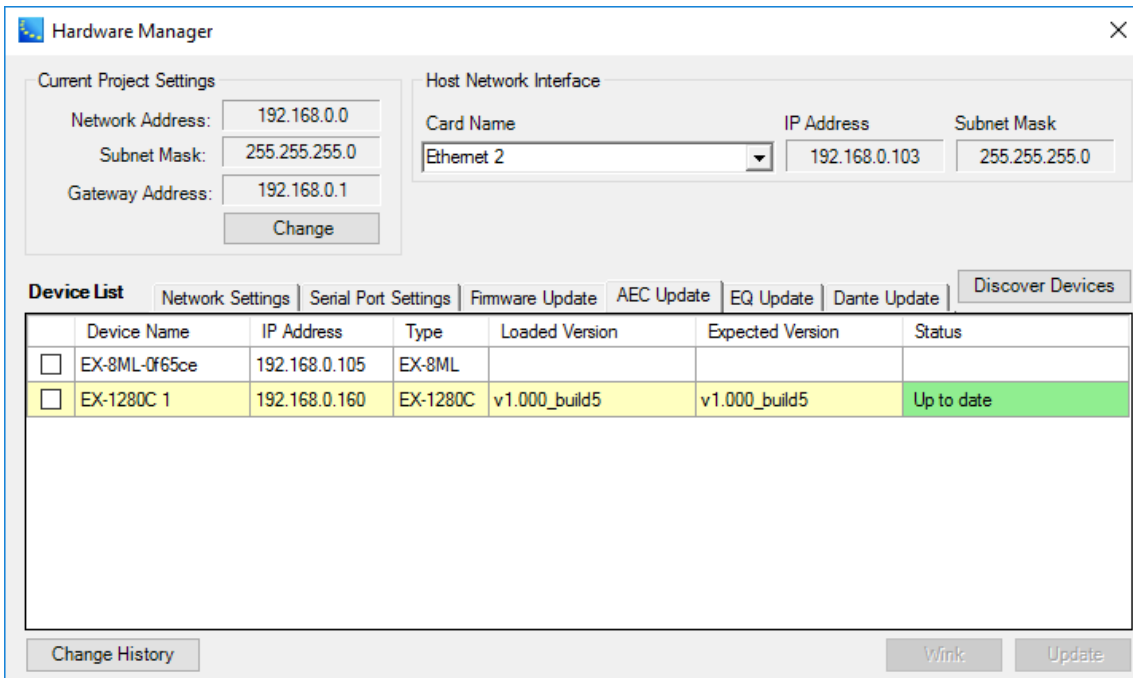

AEC Update tab example

Selecting the **EQ Update** tab displays the Loaded Version, Latest Version, and Status for the listed devices. This view supports multi-select, and automatically selects all devices with out-of-date EQ files (highlighted in pink). Clicking the **Update** button sequentially sends a new EQ file to the selected devices. Upon completion, the status column is modified accordingly.

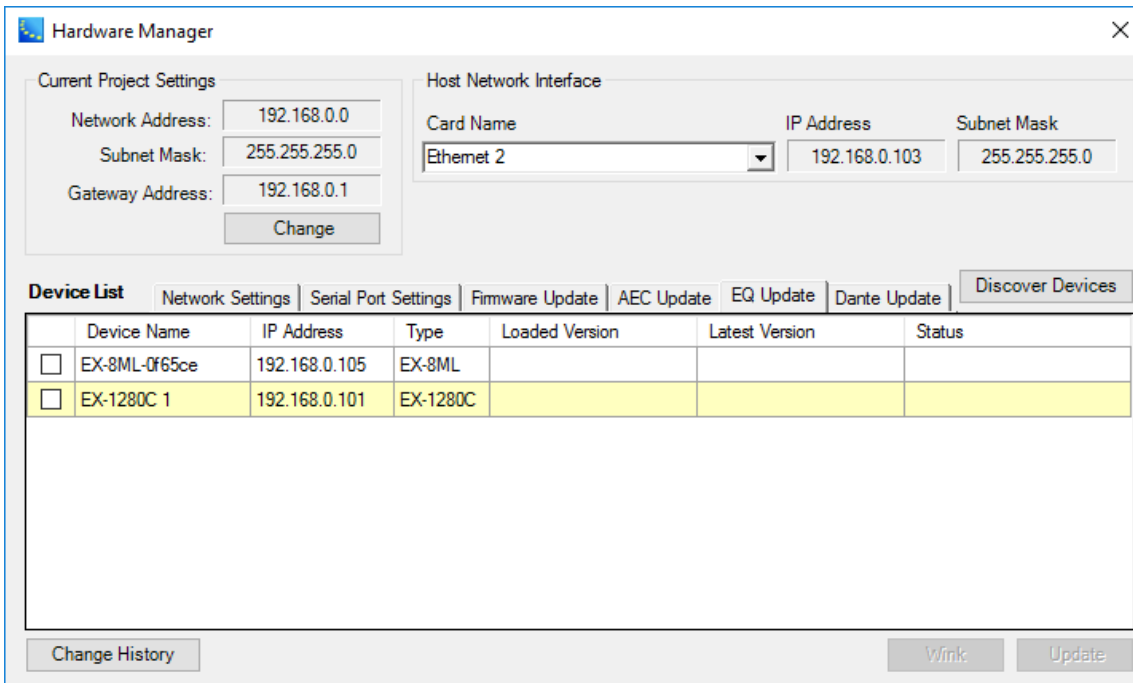

EQ Update Tab Example

Selecting the **Dante Update** tab displays the Loaded Version, Expected Version, and Status of Dante network firmware for the listed Dante network cards and Dante devices. This view supports multi-select, and automatically selects all cards and devices with out-of-date Dante network firmware files (highlighted in pink). Clicking the **Update** button launches the Audinate Dante Firmware Update Manager which is used to update the firmware in the selected Dante network devices (see [Updating Firmware in Bose® Dante Network Cards and Devices](#)). You may be asked to restart the card or device after the Dante firmware is installed. Upon completion, the status column is modified accordingly.

NOTE: You can use the Dante Update tab to update Dante endpoints only. For Dante firmware updates to the EX-1280C processor, see [Updating Firmware in Bose® Dante Network Cards and Devices](#).

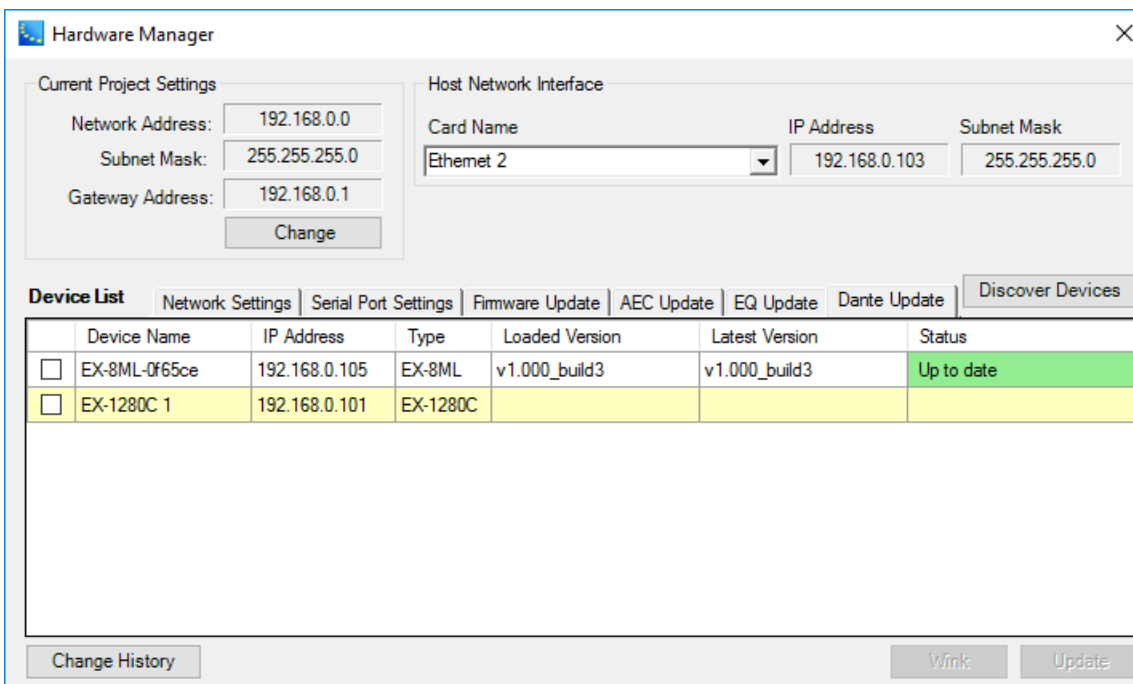

Dante Update tab example

Batch Mode

CSD software supports a Batch Mode for updating multiple devices with a single button click. In the illustration below, the project address has been changed from 192.168.0 to 192.168.1, placing each networked device outside the project. Note the status column to the right. The devices that fall outside the project are automatically preselected when opening the **Network Settings** tab. The **Batch Update** section at the bottom of the dialog shows a row entry for each selected device, and the data that places it outside the project is indicated in pink. Gateway values that are not a match with the project are indicated in goldenrod yellow.

NOTE: IP addresses are changed only if outside the selected subnet.

The screenshot shows the Hardware Manager dialog box with the following sections:

- Current Project Settings:** Network Address: 192.168.1.0, Subnet Mask: 255.255.255.0, Gateway Address: 192.168.1.1. A "Change" button is present.
- Host Network Interface:** Card Name: Ethernet 2, IP Address: 192.168.0.103, Subnet Mask: 255.255.255.0.
- Device List:** A table with columns: Device Name, IP Address, Type, MAC Address, Subnet Mask, Gateway, DHCP, Status. Two devices are listed: EX-8ML-0f65ce (IP: 192.168.0.105, Type: EX-8ML, Subnet Mask: 0.0.0.0, Status: Out of project) and EX-1280C 1 (IP: 192.168.0.101, Type: EX-1280C, MAC: A0-F6-FD-6E-43-3C, Subnet Mask: 255.255.255.0, Gateway: 192.168.0.1, Status: Out of project).
- Batch Update:** Starting IP Address: 192.168.1.2. A table with columns: Device Name, Type, Old IP Address, New IP Address, New Gateway, New Mask. Two rows are shown: EX-8ML-0f65ce (Old IP: 192.168.0.105, New IP: 192.168.1.2, New Gateway: 192.168.1.1, New Mask: 255.255.255.0) and EX-1280C 1 (Old IP: 192.168.0.101, New IP: 192.168.1.3, New Gateway: 192.168.1.1, New Mask: 255.255.255.0).

Dialog for Batch Mode

While the target IP address for each selected device cannot be explicitly set, a starting IP address is indicated, and each newly generated IP address is an increment from the initial seed value (192.168.1), skipping over IP addresses that are already in use on non-selected devices.

The **Change History** button launches the following dialog containing an entry for each change to a device network property to help keep track of their current IP, subnet and gateway state.

Index	Date	Label	Type	MAC Address	IP Address	Mask	Gateway	NIC Name
1	9/18/2017 10:25:22 ...	EX-1280C 1	EX-1280C	A0-F6-FD-6E-43-3C	192.168.0.101	255.255.255.0	192.168.0.2	Ethernet 2
2	9/18/2017 10:40:01 ...	EX-1280C 1	EX-1280C	A0-F6-FD-6E-43-3C	192.168.0.150	255.255.255.0	192.168.0.1	Ethernet 2
3	9/18/2017 10:42:23 ...	EX-1280C 1	EX-1280C	A0-F6-FD-6E-43-3C	192.168.0.101	255.255.255.0	192.168.0.1	Ethernet 2
4	9/21/2017 11:07:48 ...	EX-1280C 1	EX-1280C	A0-F6-FD-6E-43-3C	192.168.0.160	255.255.255.0	192.168.0.1	Ethernet 2

Properties Dialog launched by Change History Button

The **Current Project Settings** section of the Hardware Manager provides access to the **Set Project Network Properties** dialog via the **Change** button. The dialog initially contains the CSD default project network IP address (as well as subnet and gateway addresses), which can be modified using the New Project Network Address field. By selecting the "Use as default for New Projects" option, the same setting will be used for new projects. Normally, only the project address would be altered although the Subnet Mask and Gateway Address area can also be modified.

Whenever the project network IP address is changed, the addresses for all devices in the project are automatically modified in CSD software to conform to the new values. To transfer all these new settings to the hardware devices, make sure the devices are selected in the **Device List** and click **Update** in the Hardware Manager dialog.

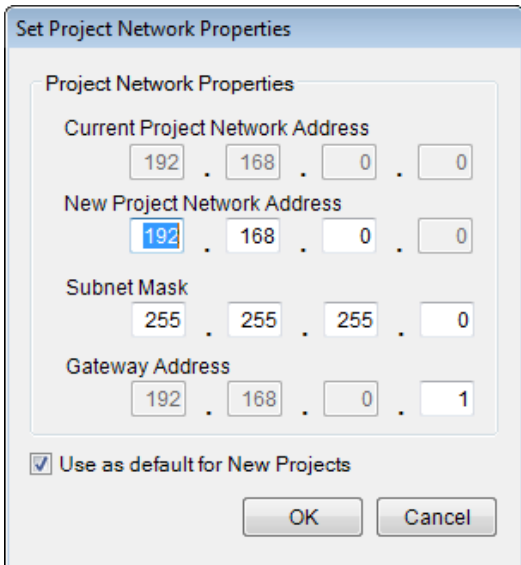

The dialog box titled "Set Project Network Properties" contains the following fields and options:

- Project Network Properties** (Section Header)
- Current Project Network Address:** 192 . 168 . 0 . 0
- New Project Network Address:** 192 . 168 . 0 . 0 (The number 192 is highlighted in blue)
- Subnet Mask:** 255 . 255 . 255 . 0
- Gateway Address:** 192 . 168 . 0 . 1
- Use as default for New Projects
-

Set Project Network Properties Dialog

Non-Networked PowerMatch Devices

When connected via USB to a non-networked PowerMatch device, only the EQ and Firmware Update tabs are available. To change the device ID, use the **Device ID** setting at the bottom of the dialog. When making changes that require a reboot, as in firmware or device ID, the dialog is dismissed upon completion.

The screenshot shows the 'Hardware Manager' window with a 'Device List' table. The table has columns for Device Name, IP Address, Type, Loaded Version, Latest Version, and Status. A single row is visible for 'PM4500 1' with a status of 'Up to date' highlighted in green. Below the table are buttons for 'Change History', 'Device ID: 6', 'Wink', and 'Update'.

Device Name	IP Address	Type	Loaded Version	Latest Version	Status
PM4500 1		PM4500	v0.019	v0.019	Up to date

The screenshot shows the 'Hardware Manager' window with a 'Device List' table. The table has columns for Device Name, IP Address, Type, Loaded Version, Latest Version, and Status. A single row is visible for 'PM4500 1' with a status of 'Out of date' highlighted in red. Below the table are buttons for 'Change History', 'Device ID: 6', 'Wink', and 'Update'.

Device Name	IP Address	Type	Loaded Version	Latest Version	Status
PM4500 1		PM4500	v2.030	v2.030	Out of date

Connecting to Devices

Connection Methods

The ControlSpace® Designer™ software supports three methods of connection to Bose system electronics and control devices:

- USB connection
- Direct Ethernet connection
- Networked Ethernet connection utilizing network switches or hubs

The connection method you use will vary based on the capabilities of the hardware device. The following table summarizes the supported connection methods for the Bose system electronics that are configured using the ControlSpace Designer software.

Connection Method vs. Device

Device	USB Connection	Direct Ethernet Connection	Networked Ethernet Connection
PowerMatch USB-only amplifier	Yes	N/A	N/A
PowerMatch networked amplifier	Yes	Cat-5*	DHCP (Default) or Fixed IP
ESP-00 II	No	Cat-5	Fixed IP
ESP-880, ESP-1240, ESP-4120, ESP-1600, or EX-1280C	No	Cat-5* (Cat-5e recommended)	DHCP (Default) or Fixed IP Note: EX-1280C supports Auto IP if DHCP server not available.
CC-64	No	Cat-5	Fixed IP
Dante Endpoints	EX-UH only	Cat-5	DHCP (Default) or Auto IP if no DHCP server

*Auto-MDIX devices resolve Tx/Rx pairs and support direct connections between a PC and the hardware using either standard or crossover Ethernet cables.

Cabling and PC Configurations

Each of the connection methods described above uses a unique connection and PC configuration. When connecting to the hardware, first determine the method of connection that will be used and then use the following reference information to determine the PC and hardware cabling, and communication settings.

Direct Connection Methods

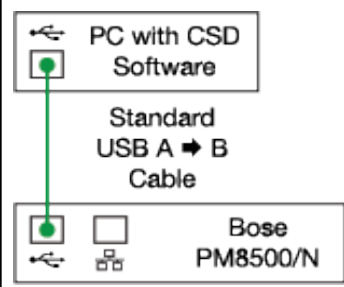
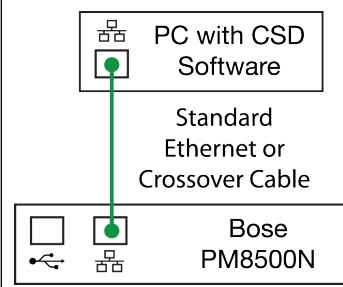
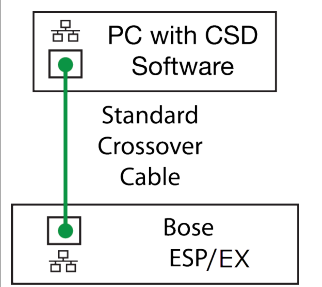
USB	Ethernet Auto MDIX	Ethernet Crossover
 <p>PC with CSD Software</p> <p>Standard USB A → B Cable</p> <p>Bose PM8500/N</p>	 <p>PC with CSD Software</p> <p>Standard Ethernet or Crossover Cable</p> <p>Bose PM8500N</p>	 <p>PC with CSD Software</p> <p>Standard Crossover Cable</p> <p>Bose ESP/EX</p>
<ul style="list-style-type: none"> PC must support USB 1.0 or greater 	<ul style="list-style-type: none"> PC configured to use TCP/IP networking Set PC Network Address to 192.168.0.10 PM8500N Default Address is 192.168.0.80 	<ul style="list-style-type: none"> PC configured to use TCP/IP networking Set PC Network Address to 192.168.0.10 ESP/EX-1280C Default Address is 192.168.0.160

Adding Devices to an Existing Network

Multiple devices can be configured for operation on an Ethernet network that utilizes network switches or routers to manage data communications between the devices. ControlSpace software is configured for operation within a single local area network (LAN) and is not designed for operation across multiple networks (i.e. communication via network gateways). In applications with large wide area networks, this requires creating a dedicated subnet for the various system processing, amplification, and control devices that will be installed.

NOTE: Bose system electronics are designed for installation on a private Ethernet network, and are not intended for a direct connection to the internet.

If you are adding your devices to an existing network, contact the network administrator for information about how the IP addresses are assigned for the network. Based on this information you will need to configure the devices for either DHCP or Fixed IP operation as shown below:

Ethernet Network Connection

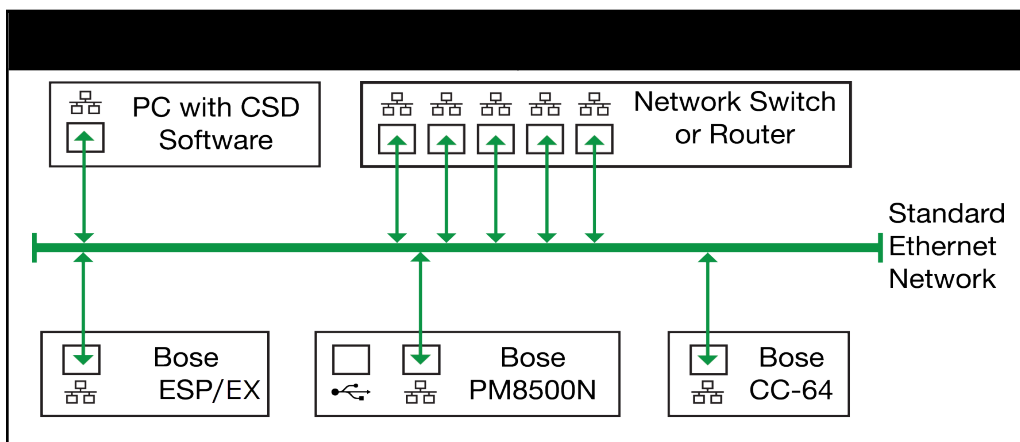

DHCP	Fixed IP
<ul style="list-style-type: none"> • PC configured for DHCP IP addressing • Requires Ethernet switch or router configured as a DHCP server • Bose PM8500N, ESPs, and EX-1280C use DHCP by default • Bose ESP-00 II and CC-64 require fixed IP 	<ul style="list-style-type: none"> • PC configured for Fixed IP • Requires Ethernet switch or route • See information on setting the IP address for various device types • See network administrator for available IP addresses

For more on device IP address management, see [Managing Device Addresses](#).

Using USB

ControlSpace[®] Designer™ software supports the control of devices which are configured for USB control, such as Bose PowerMatch[®] amplifiers.

The first time a USB-enabled hardware device is connected to the PC, the BULK USB Driver is installed. Installation is confirmed by the following message:

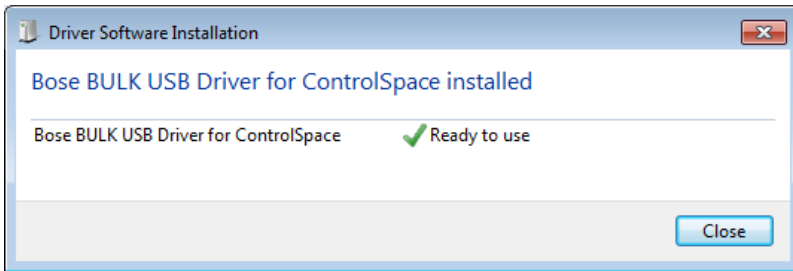

Once this step is performed, all subsequent connections via USB will occur automatically.

With the driver installed, launch the ControlSpace[®] Designer™ application. During the launch process, the PowerMatch[®] amplifier will be recognized and a new connection will be established.

The USB connection is indicated by a blue-green background color. At this point, it is possible to modify the signal processing settings in real time.

For more information on connecting to and controlling devices via USB, see [USB Connection](#).

Direct Ethernet

Standard or crossover Ethernet cables can be used to directly connect your PC to the Bose device.

Auto-MDIX Ethernet ports

The Bose[®] PowerMatch[®] amplifiers use Auto-MDIX Ethernet ports that automatically correct for the cable type used for network connections. With this hardware, it is possible to use either a standard or crossover Ethernet cable and accomplish a direct connection between the PC and the hardware.

In this configuration, the only difference in the set up is that a standard Ethernet cable is used between the PC and the hardware, all other network configuration parameters are identical to those used for a direct connection with a crossover cable.

Ethernet cables

When connecting the PC directly to either a single ESP or EX-1280C processor or PowerMatch amplifier, a standard or crossover Ethernet cable can be used. This connection does not require the use of a network management device, (switch, router or hub), but does require that you properly configure your PC for communication with the device.

Device Connection Status

Within the ControlSpace[®] Designer™ software the background color of the Project View, and title bar of devices within the Project View are used to indicate the current status of the device when a connection to the system is established.

Project and Signal Processing View Device Status

Connection Status	Background Color
Offline	White
USB connection established	Green
Ethernet connection established	Blue
Ethernet connection established, device offline	Gray (Signal Processing View only)
Connection established, device in standby	Yellow (Signal Processing View only)

NOTE: The background color of the Project View and Signal Processing View is gray when System Mute is engaged.

Project View Icon Device Status

Connection Status	Device Color
Offline	Default color
Connection established	Default color
Device offline	Gray
Device in standby	Yellow

Network Scan

The Network Scan function can determine which devices are currently active on the ControlSpace[®] network, without actually connecting to the system. In general, the Network Scan should only be used with a new, blank project as a means to identify what hardware already exists on the local network as the Project View will be populated with these devices.

NOTE: The Network Scan only retrieves device configuration information and does not include any signal processing or control programming information stored within the device.

To identify the devices on the network, go to the main toolbar and click the Scan button  (or press Alt + T, S). Once the scan is completed the Project View is automatically populated with the devices in your local network.

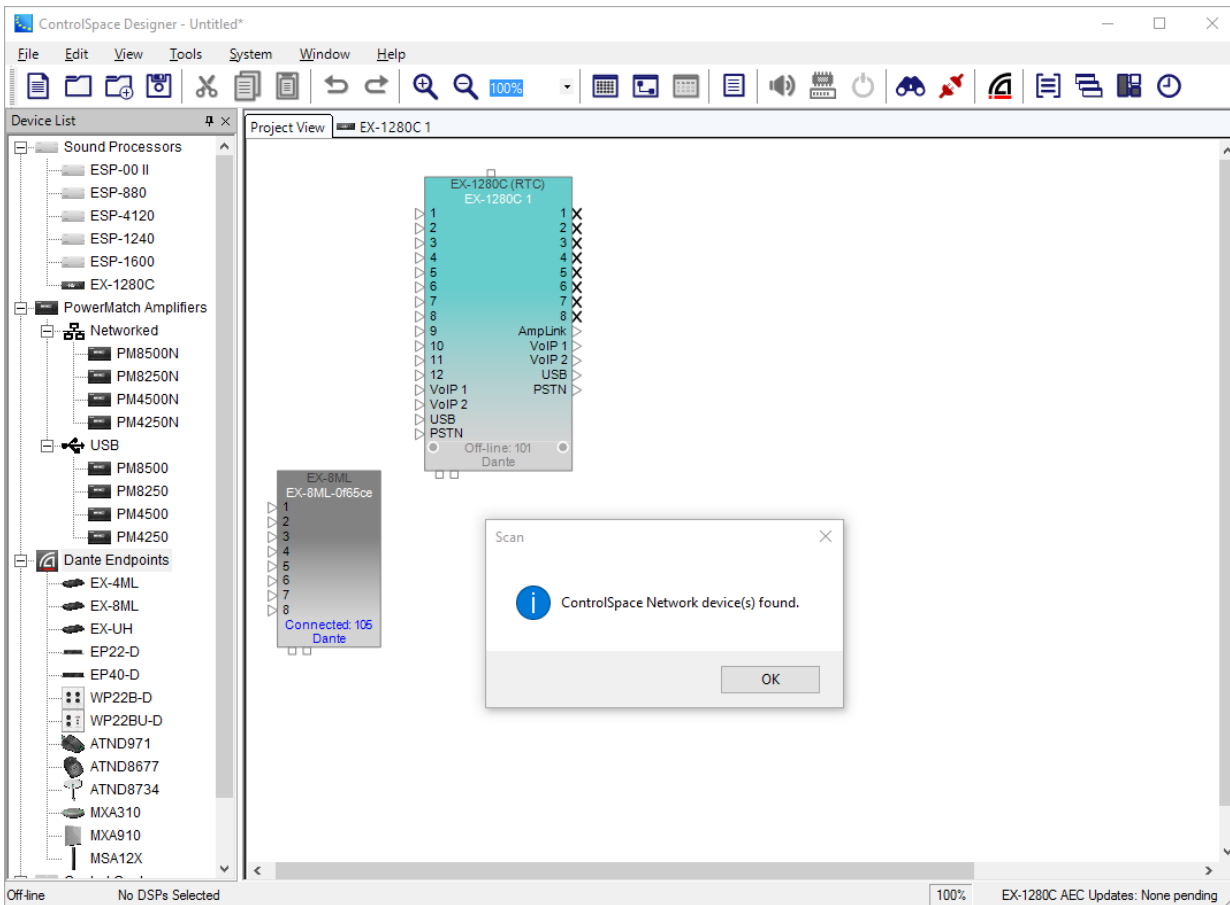

Scanning for devices

Error Messages

If no devices are present on the network you will receive an error message stating that no devices were found:

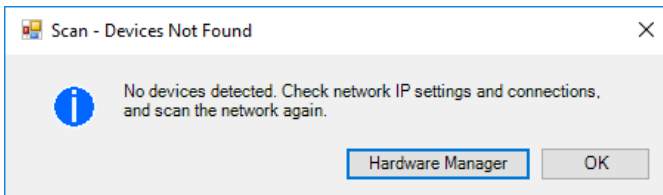

No devices detected message

In this situation, verify that the devices are powered on, and that the PC IP address and the Project Network Address within ControlSpace® Designer™ software are configured for the same primary network addressing scheme as the hardware.

When performing a Network Scan, additional errors may be generated notifying you of the need to update device firmware and EQ database files.

When performing a Network Scan with devices already added to the project, the following additional errors may be generated:

- **Configuration Mismatch**
- **Devices Not Found**

Setting Device IP Addresses

When changing the project network address, the IP addresses, gateway and subnet mask addresses of all devices in the project will be modified to be consistent with the new project settings. To change the IP of a project networked device, including all ESPs, EX-1280C, PM, CC-64, and CobraNet cards, launch the device properties dialog and click the **Set IP Address** button. For convenience, these dialogs also have a link to the Hardware Manager.

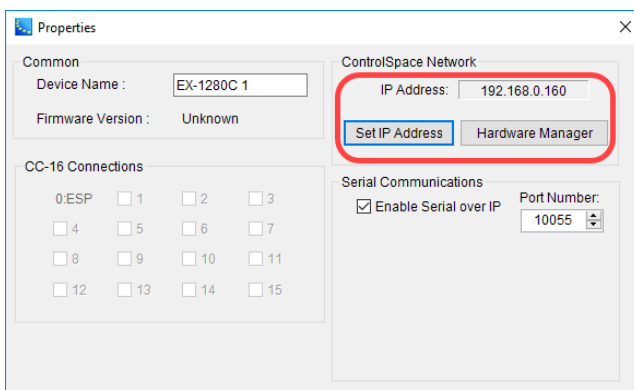
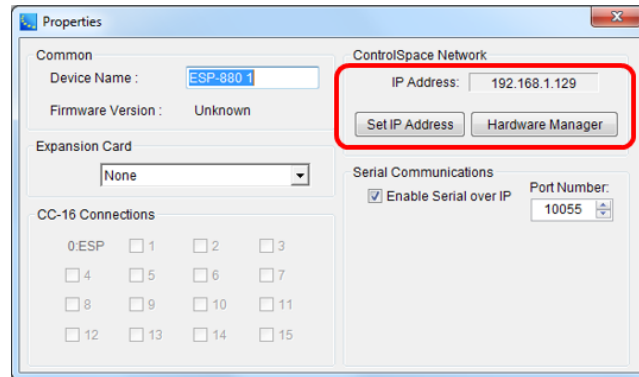
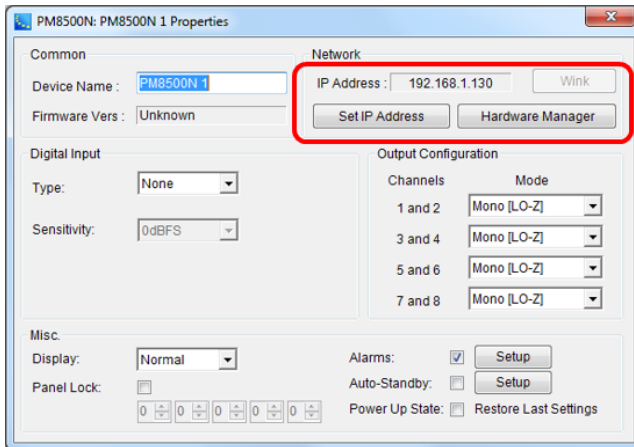
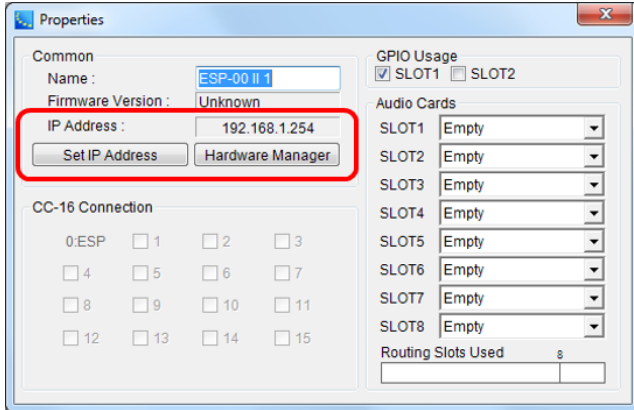

After clicking the **Set IP Address** button, the **Set Device IP Address** dialog is displayed. For convenience, the project properties are displayed across the upper portion, including the range of IP addresses that lie within the project subnet. The project subnet mask dictates the octets within the IP address that can change and still fall within the target range. However, unless the mask is the default \24 or \16, there will be some addresses that can be entered that are not allowed. In that case, a warning will be issued, and the original IP address restored.

IP Address	Device Name	Device Type
192.168.0.160	EX-1280C 1	EX-1280C

NOTE: Dante is not supported remotely. When in Remote Mode, right-clicking on a device or Dante card will offer the option to display the Dante properties as queried by the host device, but will not launch Dante communication.

Connecting to a System

Once the system is configured for operation on the ControlSpace[®] Network you can connect to the system, upload a configuration, and control the system's operation. ControlSpace[®] Designer™ offers the option of either sending the current configuration to the hardware, or retrieving the stored configuration from the hardware when connecting to the system.

The system connection process used is based on the current state of the Project View at the start of the connection process. The possible states are:

- Empty Project View
- Project View populated from a network scan
- Project View populated with devices from a ControlSpace Project File (.CSP)

Empty Project View

An immediate connection to the system is initiated using the **Go Online**  button in the main toolbar, or by selecting **Tools > Go online**. In this scenario, no devices are present within the Project View.

1. In the main toolbar, click the **Go Online** button to initiate a connection.

If the Project View does not contain any devices you will be asked to select the device which contains the Project File:

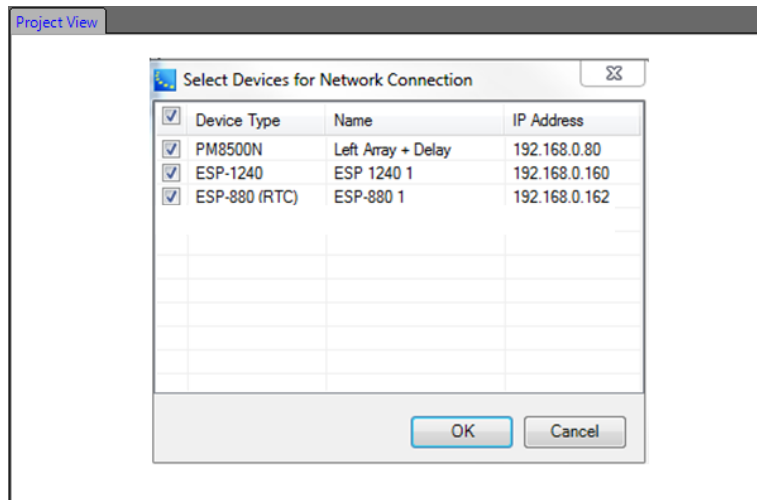

NOTE: The Project File contains information related to control programming for the system, and the display of the system devices within the Project View.

2. Select the device which contains the Project File and click **OK**. You are now connected to the system.

Project View Populated from a Network Scan

In this scenario, the Project View contains devices which were added to the view using the network scan function. When a network scan is performed only configuration information is retrieved from the system devices. Any information related to signal processing functionality and settings, and control programming is still resident within the devices, and has not been retrieved for display within ControlSpace Designer software.

To perform a network Scan to identify any active devices on the ControlSpace Network:

1. Click the network **Scan** button  in the main toolbar.

The Project View is now populated with all the devices currently active on the network:

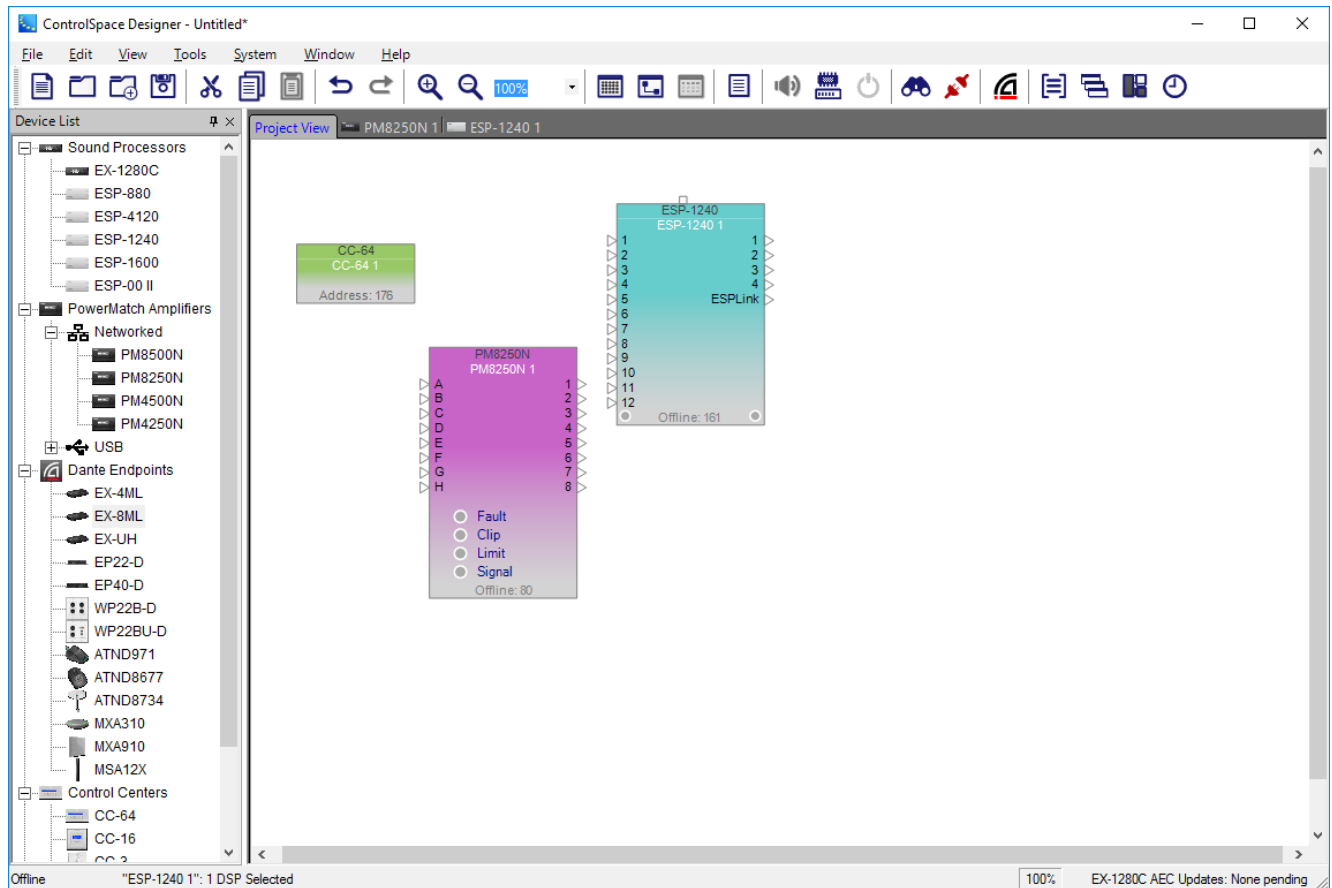

2. Click the **Go Online** button in the main toolbar to initiate the connection.
You will be asked to select which settings you wish to use for this connection session.
3. Select **Get from Devices (download design)**.

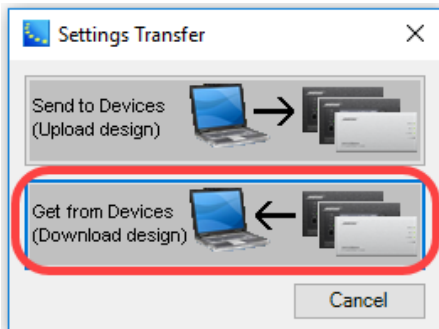

This will cause the settings within the hardware to be used. If the settings within the Project View were applied, (upload design), it will replace any signal processing and control parameters with the default hardware settings.

4. When asked to save changes to the current document select **No**.
5. Select the device which contains the Project File and select **OK**.

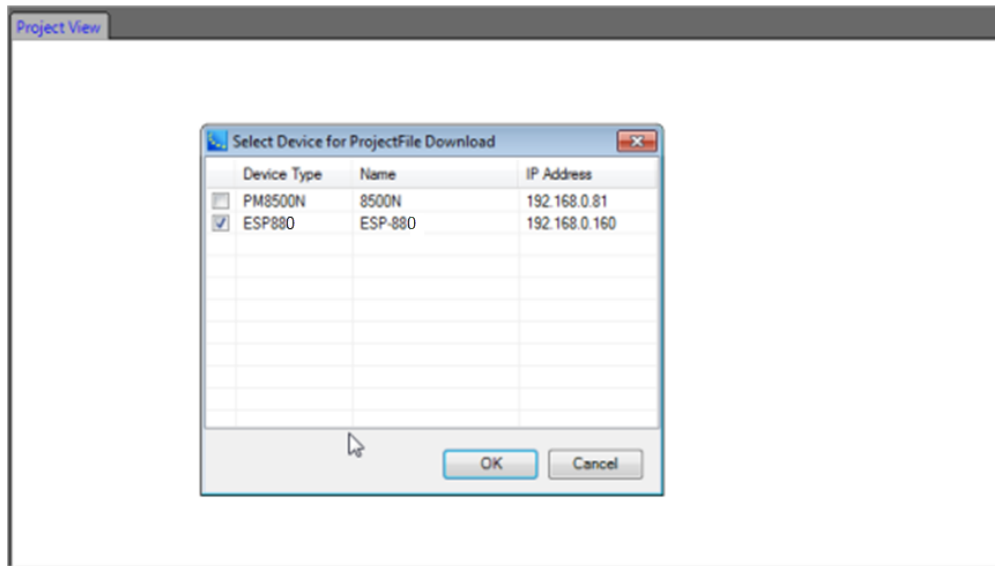

NOTE: The Project File contains information related to control programming for the system, and the display of the system devices within the Project View.

You are now connected to the system.

If all system devices contained in the Project File are active on the network, they will all be present and available. If any devices were not active on the network, but present in the Project File they will be indicated as being off-line.

Project View Populated With Devices from a ControlSpace Project File

This method of connecting to the system is the most common for new system configurations. In this case the Project File has been built to represent the desired system signal processing and control functions which need to be applied to the hardware.

1. Open the desired Project File.
2. Click the **Go Online** button  to initiate a connection.

You will be asked to select which settings you wish to use for this connection session.

3. Select **Send to Devices (upload design)**.

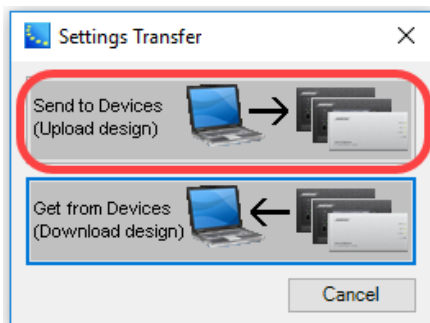

4. Select the devices on the network to which you will connect. In this case, select all devices and click **OK**.

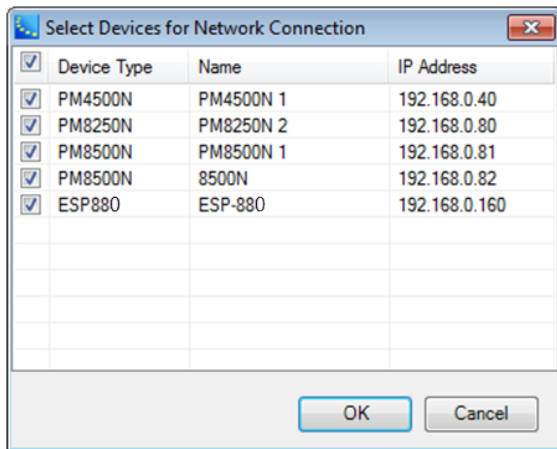

5. Select the devices which will have a copy of the Project File stored within them.

The Project File contains all device control programming and signal processing information. While it is not necessary to store it in all system devices, it should be stored within the main signal processing unit for future connections.

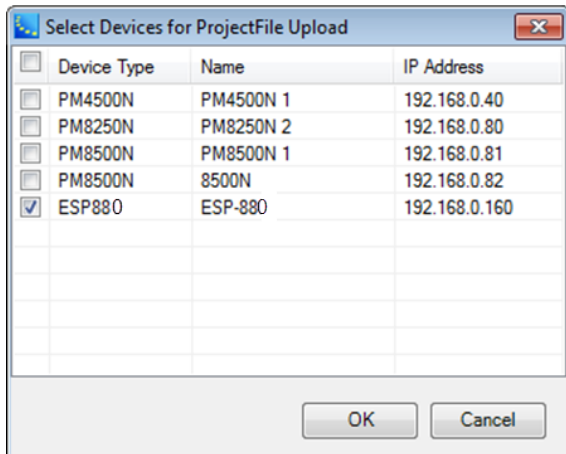

The signal processing and control parameters (Netlist) are transferred to all system devices and the Project File is stored in any selected devices. You are now connected to the system.

When connecting to a system using a Project File, it is possible to receive a configuration mismatch or device-not-found error:

Configuration Mismatch Error: The hardware configuration of the device on the network does not match the configuration of matching device, based upon its IP address, within the design. For example, a PowerMatch amplifier which uses a different output configuration from the one within the design in ControlSpace Designer software. When the device configurations do not match a dialog is presented to describe the differences in the configurations, and to allow you apply the correct configuration to either hardware or to the design.

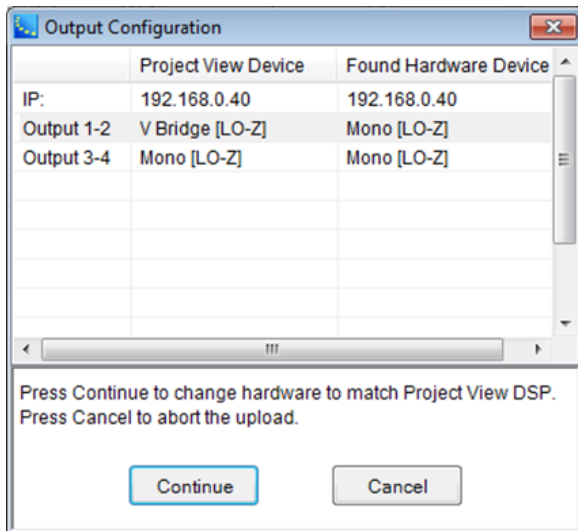

Connection Error – Configuration Mismatch

Select **Continue** to send the Project View configuration to the hardware, or **Cancel** to cancel the operation.

Devices Not Found Error: If the project file contains devices that are not active on the network you will receive an error message to notify you of the devices that are present on the network, and the devices in your design which cannot be located.

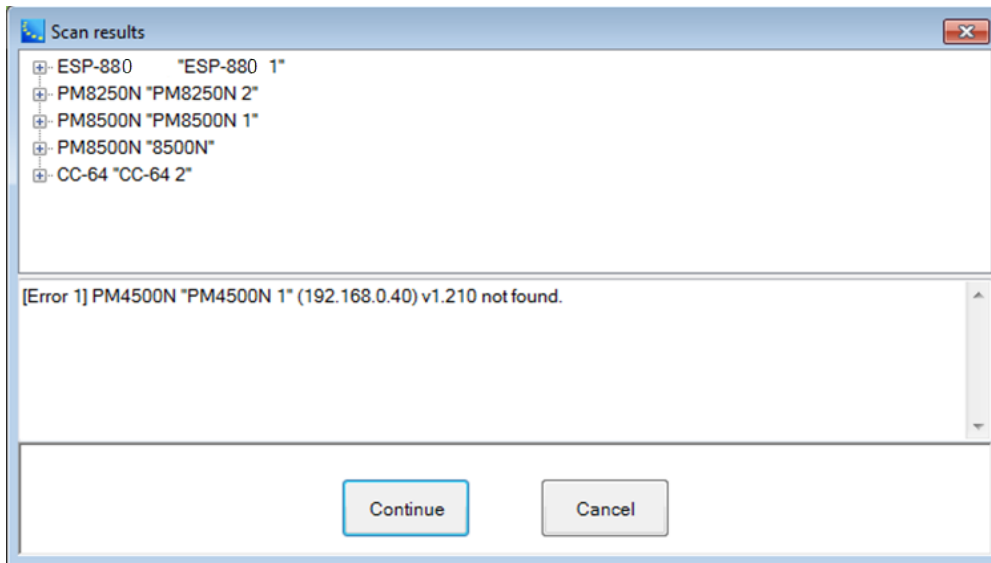

Scan Error - Devices not found

Select **Continue** to connect to the system, the missing device will appear in the Project View as being off-line. Press **Cancel** to cancel the connection to the system.

NOTE: ControlSpace Designer will only establish a connection with those devices that are included in the configuration file. If you do not see a device once the connection is established, it must be added to the configuration file, and the new configuration must be uploaded to the system.

Disconnecting From the System

NOTE: This section applies to networked devices only.

When disconnecting from a networked system you will be prompted to save any changes that were made during the session. Not saving the changes will cause them to be lost during the next power cycle of the system.

The nature of a ControlSpace[®] Networked system is that each device on the network powers up to a pre-defined state. Any changes made to the system during operation are not recalled at the next power-up, unless they were expressly saved to system devices using ControlSpace[®] Designer[™] software. When saving the configuration to the hardware you want to make sure that all system settings are in the desired power-on state.

When disconnecting from the system use the following steps:

1. Make sure that all system settings are in the desired power-on state for the system.
2. Click the **Go Offline** button  in the main toolbar to initiate the disconnection process.

If no changes were made to system settings during the session you will be immediately disconnected from the system. When a change of any sort to the signal processing settings has been made you will be prompted to save the settings to the system devices:

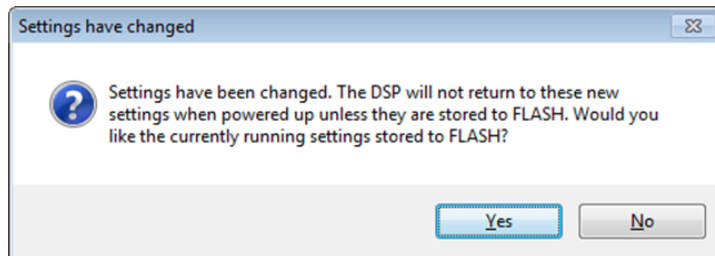

3. If you wish to make the current settings the new Power-On State select **Yes**. Otherwise you can select **No** and the current settings will not be restored at the next Power On – rather the previously saved configuration will be recalled, and you will immediately go offline from the system.
4. When selecting **Yes** you will be asked in which of the system devices you would like to save the Project File – which contains device signal processing and control information.

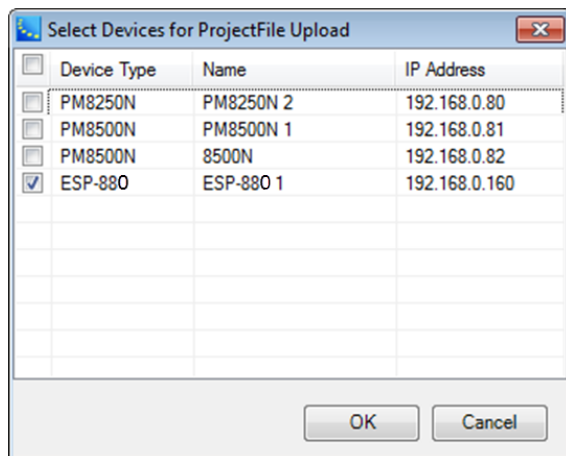

NOTE: You must save the Project File to at least one system device so that it can be recalled in future connection sessions. Not doing this could cause you to lose information about the systems signal processing and control settings.

5. Select the desired device or devices and click **OK**.
6. Once the settings and Project File has been transferred to the devices you will be disconnected from the system.

Dante Digital Audio Networks

Dante™ Network Audio

Dante™ Network Audio is built into the EX-1280C sound processor and supports 64 x 64 audio channels. Dante™ network cards are available for Bose ESPs and PowerMatch® configurable professional power amplifiers. Each of these network cards use industry-proven Dante technology to transport multiple channels of high quality, uncompressed digital audio in real time across a standard Ethernet network.

Bose Dante network functionality supports both switched and redundant operation – allowing Bose EX-1280C, ESPs and PowerMatch amplifiers to be integrated into small systems without additional network hardware and into large systems utilizing multiple endpoints and redundant network design.

All EX-1280C and ESP-880/1240/4120/1600 sound processors (with a Dante network card installed) are capable of receiving both ControlSpace control data and Dante audio data from the Dante network. ESP-00 II engineered sound processors and PowerMatch amplifiers do not have this capability and require a physically separate audio and control connection.

All Dante devices operate on a standard Ethernet network and use standard Ethernet switch hardware to manage data traffic.

Basic Dante Network

A basic Dante network consists of a managed Ethernet switch, Dante endpoints, and a DHCP server. Dante endpoints can be any type of device from any manufacturer, provided they support the Dante audio network protocol.

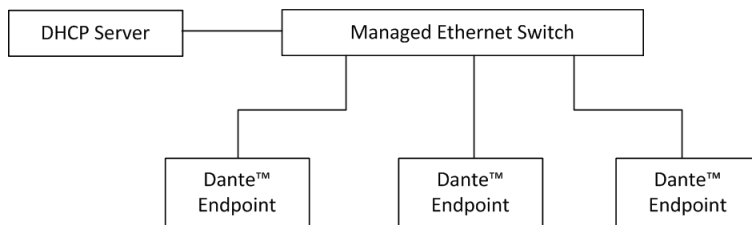

All Dante endpoint devices operate using DHCP as default, and will wait to receive a network address from the DHCP server. If a DHCP server is not present, Dante devices will default to a predefined IP address within the range of 169.254.x.x.

Combined Digital Audio and Control Network

A combined digital audio and control network integrates both control and audio data onto a common Ethernet network. Using standard network switch configuration parameters, it is possible to optimize the flow of both types of data traffic to provide the best system performance. The following example illustrates how Bose ControlSpace engineered sound processors and PowerMatch amplifiers are integrated into a Dante digital audio network.

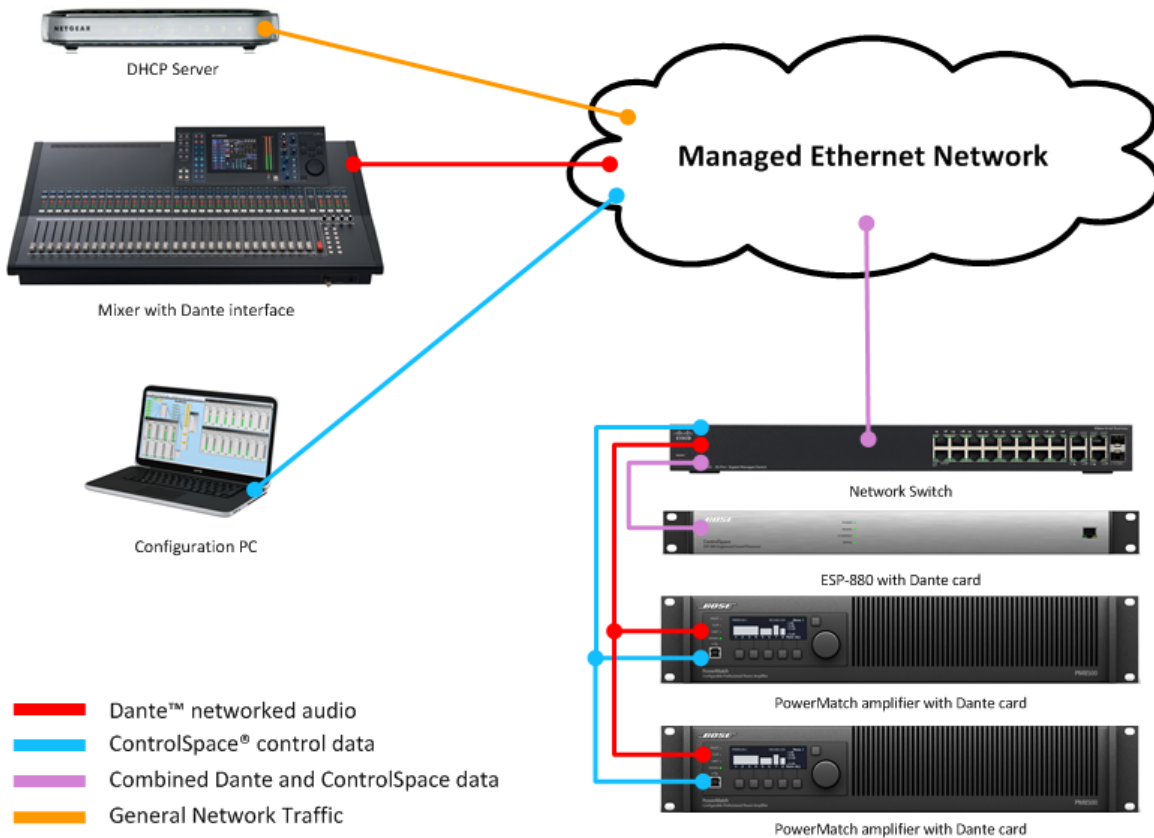

Example system with Dante network audio

The Bose® ControlSpace® ESP-880/1240/4120/1600 and EX-1280C sound processors can be easily integrated into a combined data and control network. PowerMatch® amplifiers require physically separate control and data connections to the network, as does the ControlSpace ESP-00 II engineered sound processor. In the case of the ESP-00 II and the CC-64 control center, these devices operate at a much slower network speed and require additional configuration when being integrated into a larger Dante digital audio network.

Dynamic Routing for Dante Networks

Enabling Dynamic Routing

For projects that allow dynamic changes to audio routing between ControlSpace and networked PowerMatch devices using Parameter Sets, select **Enable Dynamic Routing** from the System menu. Dante Control must be enabled for this option to be available.

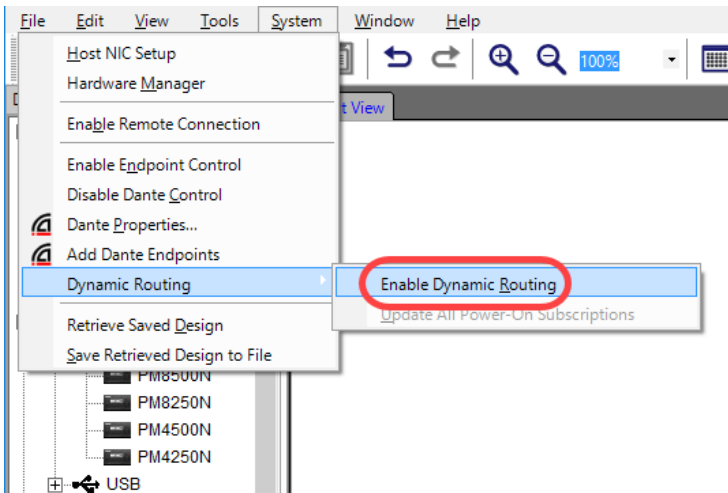

When dynamic routing is enabled, Dante input blocks added to Parameter Sets will also include the subscription information (routing). This allows routing changes to be recalled as required during system operation. For more information, see ["Programming Dante Subscriptions into Parameter Sets" on page 439](#).

With dynamic routing enabled, the ControlSpace and PowerMatch devices receive 'Power-On' subscriptions that restore them to a known state consistent with the rest of the system at power-up. For more information on how to set up and store the power-on routing, see ["Setting the Dante Routing Used for Power-On" below](#).

Setting the Dante Routing Used for Power-On

To ensure that the routing returns to a known state that is consistent with the rest of the power-on settings for the system, the ESP/EX-1280C processors and networked PowerMatch amplifiers recall designated 'power-on' subscriptions. These can be updated per module, per device, or for the whole system.

To set a power-on subscription, first set up the system with the desired routing. Once the routing is correct, use one of the following options to capture the settings.

- To capture settings for all the devices at the same time, select the **Update All Power-On Subscriptions** option in the **System > Dynamic Routing** menu. Dante Control and Dynamic Routing must be enabled for this option to be available.

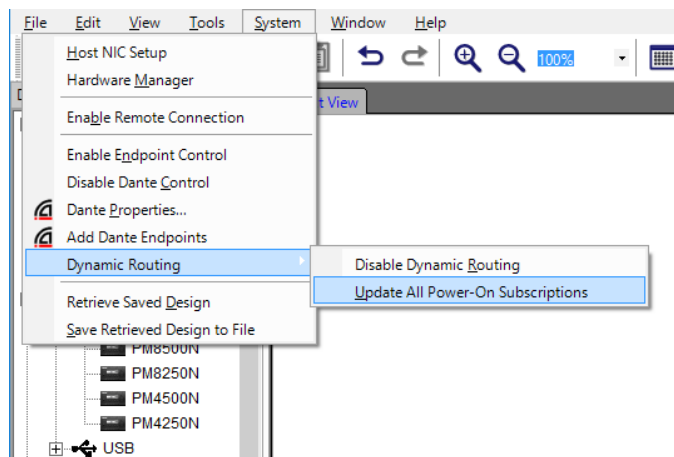

- To capture settings for a single device, right-click on the device in Project View and select **Update Power-On Subscriptions**. Dante Control and Dynamic Routing must be enabled for this option to appear.

in the context menu.

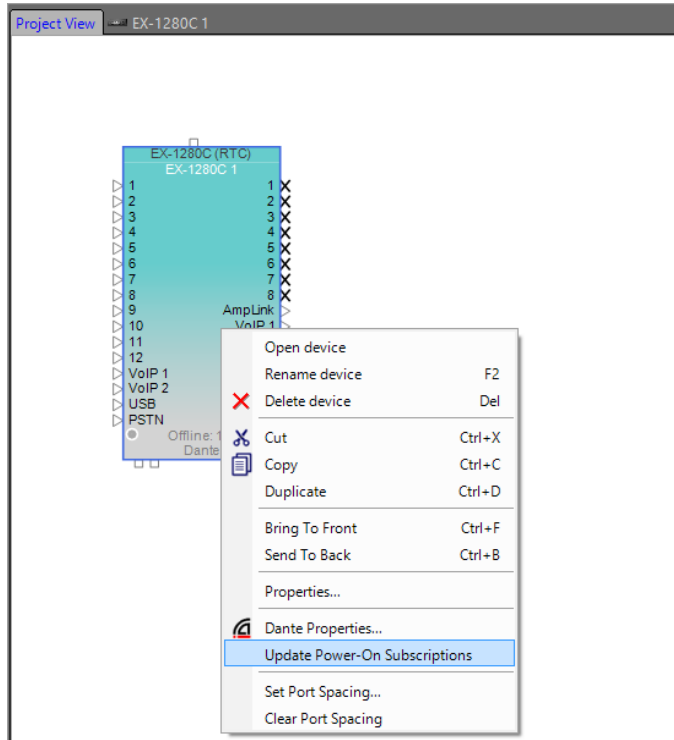

- To capture settings for a single ESP/EX-1280C Dante Input block, right-click on the block in Device View and select **Update Power-On Subscriptions**. Dante Control and Dynamic Routing must be enabled for this option to appear in the context menu.

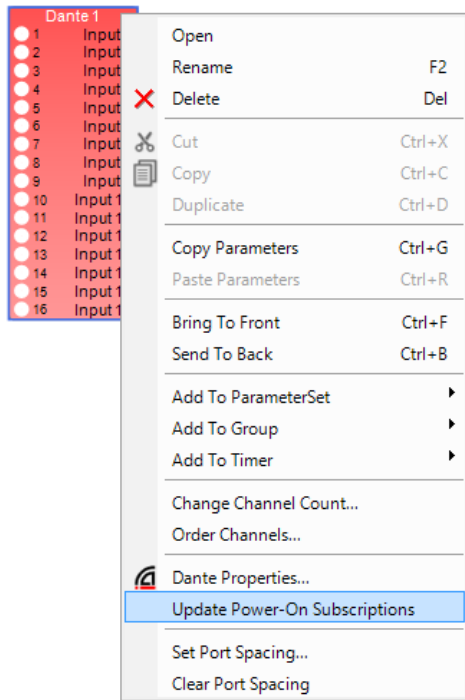

View the saved 'Power-On' subscriptions for any Dante input block in the Properties Window. Use this to check which 'Power-On' subscriptions will be sent to the hardware when opening and uploading an existing file.

To view the subscription settings, select the Dante Input block in Signal Processing View and then select **Window > Properties** from the main menu. If Dynamic Routing is enabled, then the Properties Window displays both the Current Subscriptions and the Power-On Subscriptions. If Dynamic Routing is disabled, then the Properties Window displays the Current Subscriptions only.

Subscriptions - Current	
Subscription (1)	Ch 1;PM85TCDN
Subscription (2)	Ch 2;PM85TCDN
Subscription (3)	Ch 3;PM85TCDN
Subscription (4)	Ch 4;PM85TCDN
Subscription (5)	Ch 5;PM85TCDN
Subscription (6)	Ch 6;PM85TCDN
Subscription (7)	Ch 7;PM85TCDN
Subscription (8)	Ch 8;PM85TCDN
Subscriptions - Power-On	
Power On Subscription (1)	0;
Power On Subscription (2)	0;
Power On Subscription (3)	0;
Power On Subscription (4)	0;
Power On Subscription (5)	0;
Power On Subscription (6)	0;
Power On Subscription (7)	0;
Power On Subscription (8)	0;

Dante Properties Window with Dynamic Routing enabled

Subscriptions - Current	
Subscription (1)	Ch 1;PM85TCDN
Subscription (2)	Ch 2;PM85TCDN
Subscription (3)	Ch 3;PM85TCDN
Subscription (4)	Ch 4;PM85TCDN
Subscription (5)	Ch 5;PM85TCDN
Subscription (6)	Ch 6;PM85TCDN
Subscription (7)	Ch 7;PM85TCDN
Subscription (8)	Ch 8;PM85TCDN

Dante Properties Window with Dynamic Routing disabled

NOTE: Power-On subscriptions will not affect the current routing when uploading the design file to hardware. Routing is only affected when the hardware is rebooted.

User Interface

Interface Overview

The ControlSpace® Designer™ software interface consists of three primary areas:

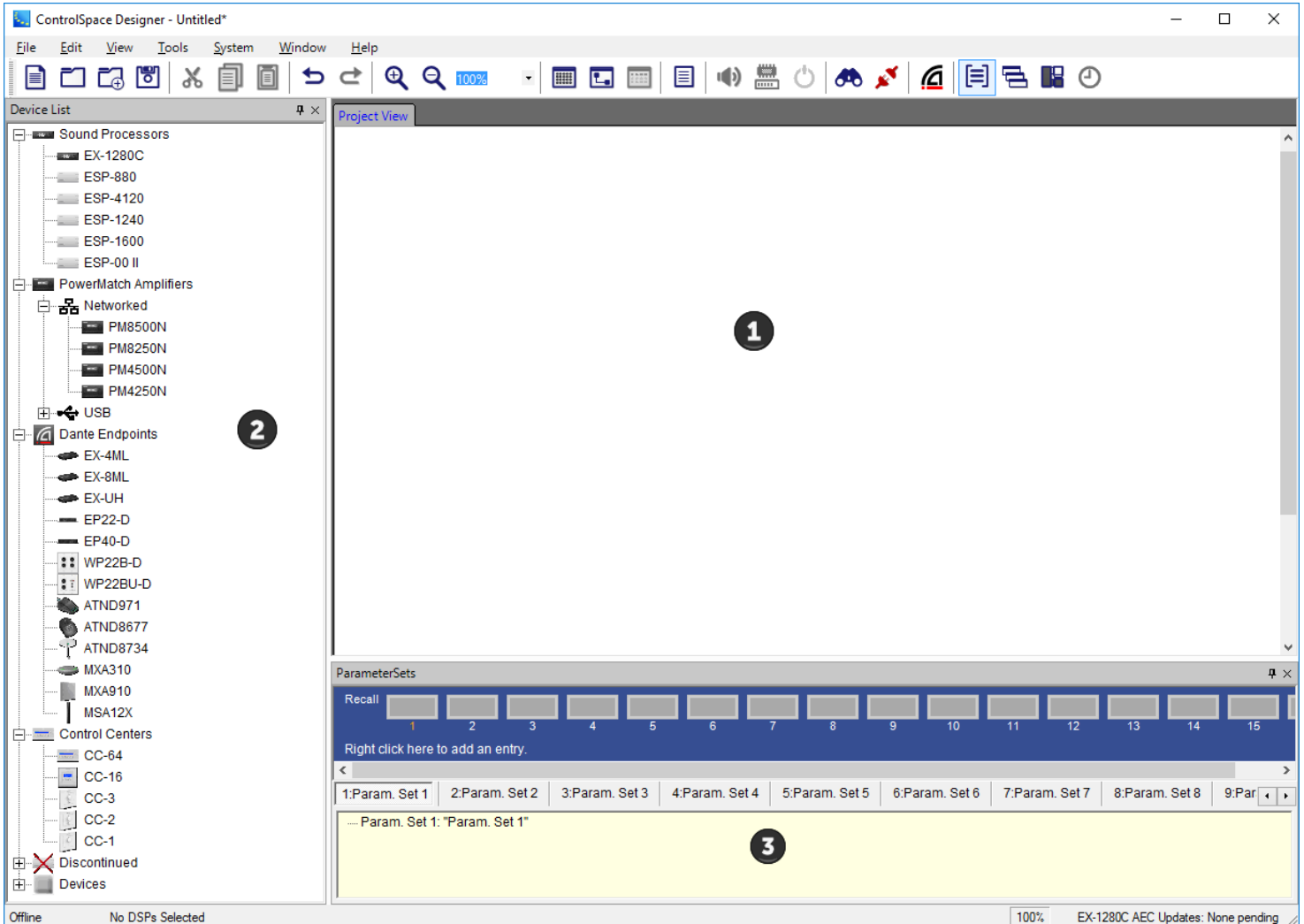

- 1 Design Workspace** - Used to define system devices, create signal processing diagrams, and to access operational screens for various devices and signal processing objects.
- 2 Device List/SP Tool Kit** - A context-sensitive panel that lists devices that can be added to the system design in Project View, or when an ESP, PM, or EX-1280C device tab is selected, lists signal processing tools.
- 3 Control Library Functions** - Used to display system control functions placed in Parameter Sets, Groups, RCGroups, and Timers.

While a number of additional views, and windows are available, these three elements comprise the primary work areas.

Windows Reference

Design Workspace

The Design Workspace is used to define the system devices, create the signal processing diagram that will be implemented within the ESP or EX-1280C and access the operational screens for various devices and signal processing blocks.

Create your system design by dragging and dropping individual processing and control components from the **Device List** into the **Project View**. The **Project View** represents a block diagram of all system components and their interconnections.

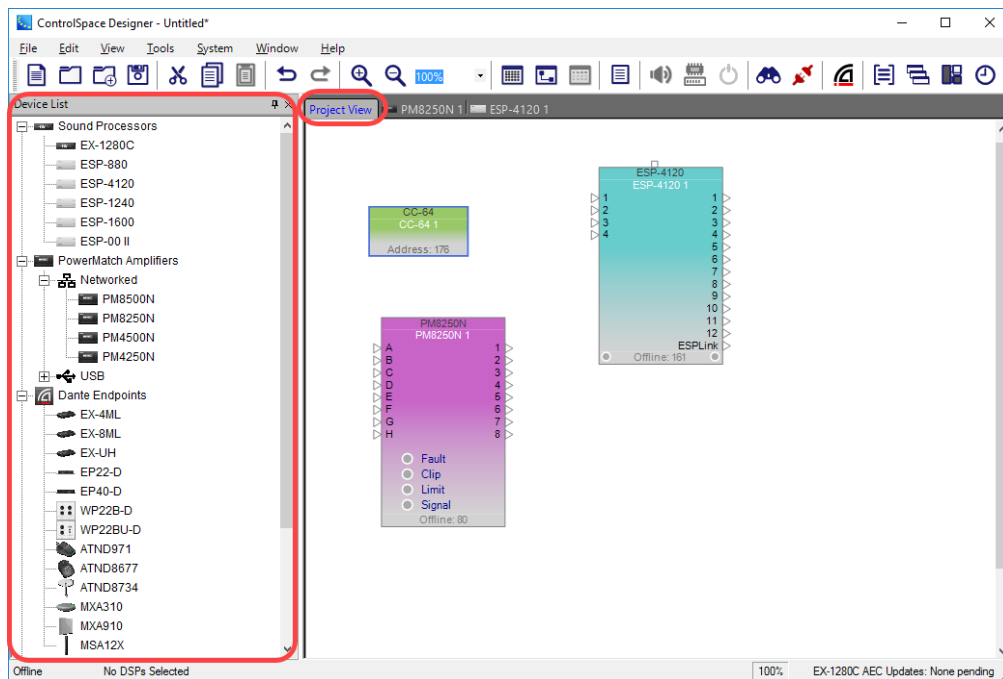

Device Tab and Signal Processing View

Once a system component is added to the design, a new **Device Tab** for the component is created. Selecting the **Device Tab** displays the Signal Processing View for the device.

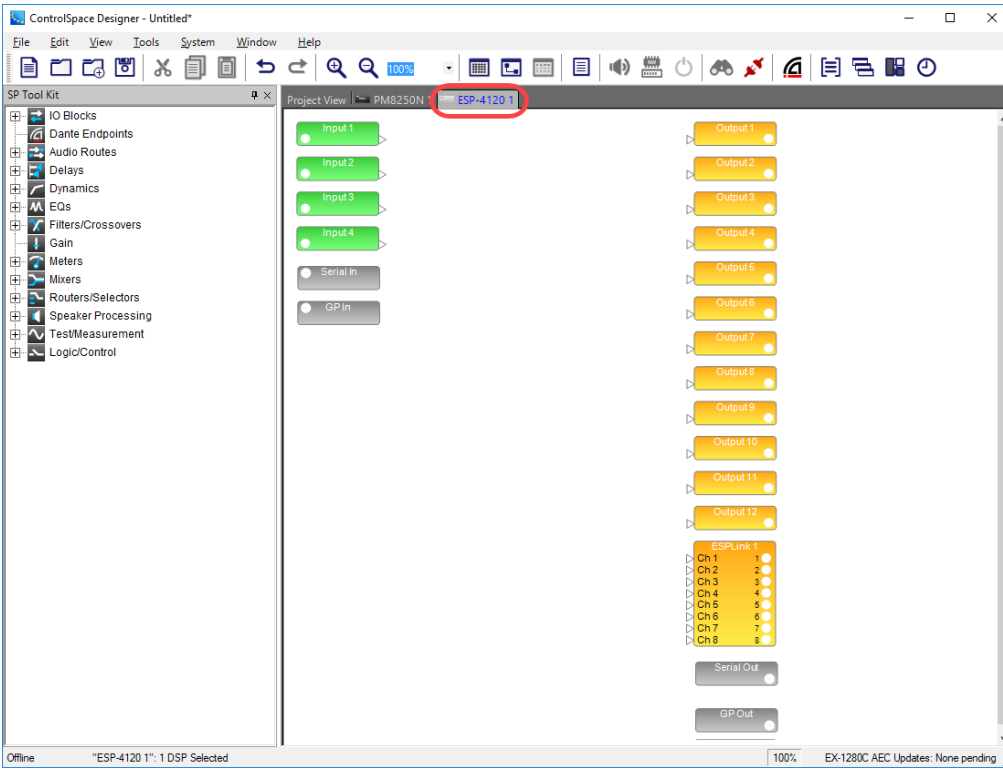

SP Tool Kit

The **SP Tool Kit** contains all the available signal processing blocks for use in the selected device. Drag and drop these blocks into the **Signal Processing View** in the Device tab on the right to configure your system.

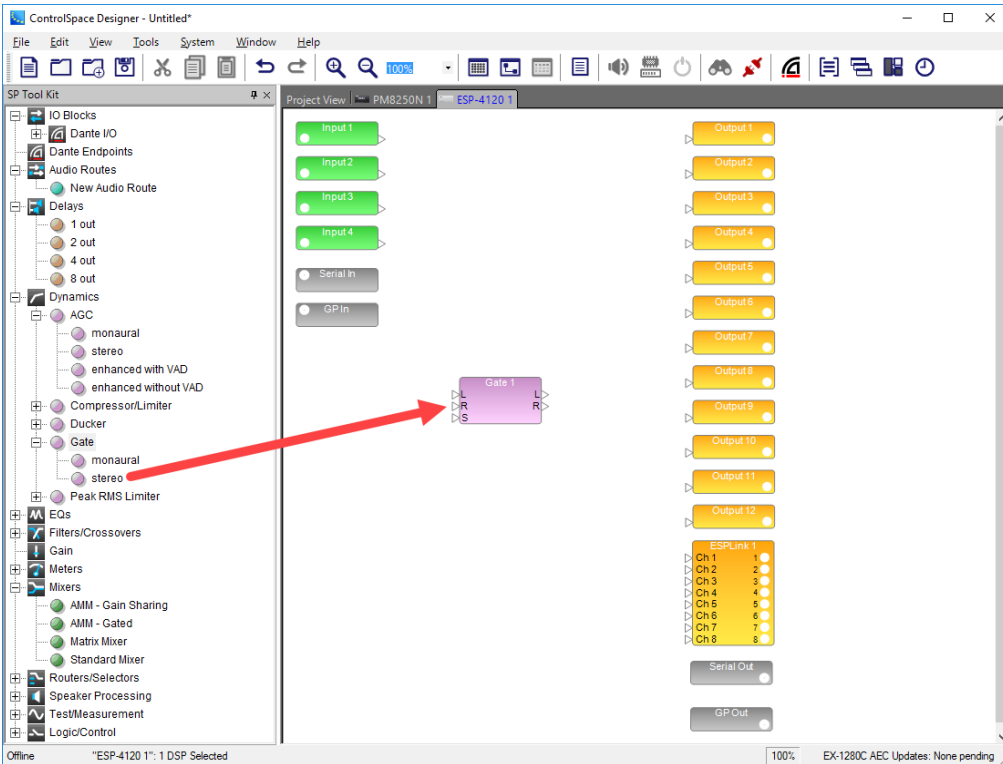

Wiring Between SP Blocks

Basic wiring in Signal Processing View is accomplished by selecting an output port on the sending SP block and dragging the wire to an input port on the receiving SP block.

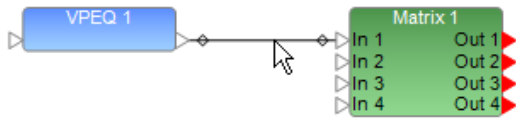

The same wiring functions are also available for devices in Project View. See [Wiring Operations](#) for a description of more wiring functions.

NOTE: The wiring shown in the Project View is representational only and it does not affect the signal path. As such, not including wiring in the Project View will not affect the operation of your design. However, the devices within the Signal Processing View must be wired together to successfully route audio from inputs to outputs.

Renaming a Device or Signal Processing Block

All devices displayed in the Project View and blocks in Signal Processing View have a user-definable label. To **rename a device or signal processing block**, right click on the icon to display the context menu and select **Rename** or press the F2 key and enter the new label. Alternatively you can change the device or signal processing block's Label property in the Properties window.

Device List

The Device List contains a list of devices that may be dragged and dropped into the Design Workspace. When you drag a device block into the Design Workspace, a device tab containing the Signal Processing View is added for that device. When you select the device tab, only the signal processing blocks that are applicable to that device are shown in the SP Tool Kit.

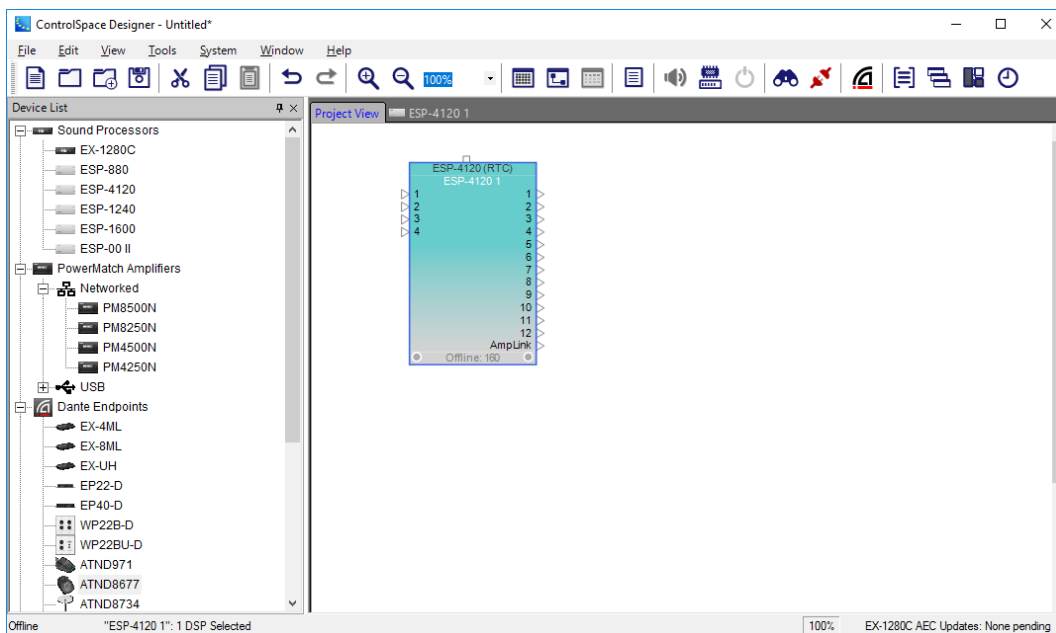

Device List - Project View tab selected

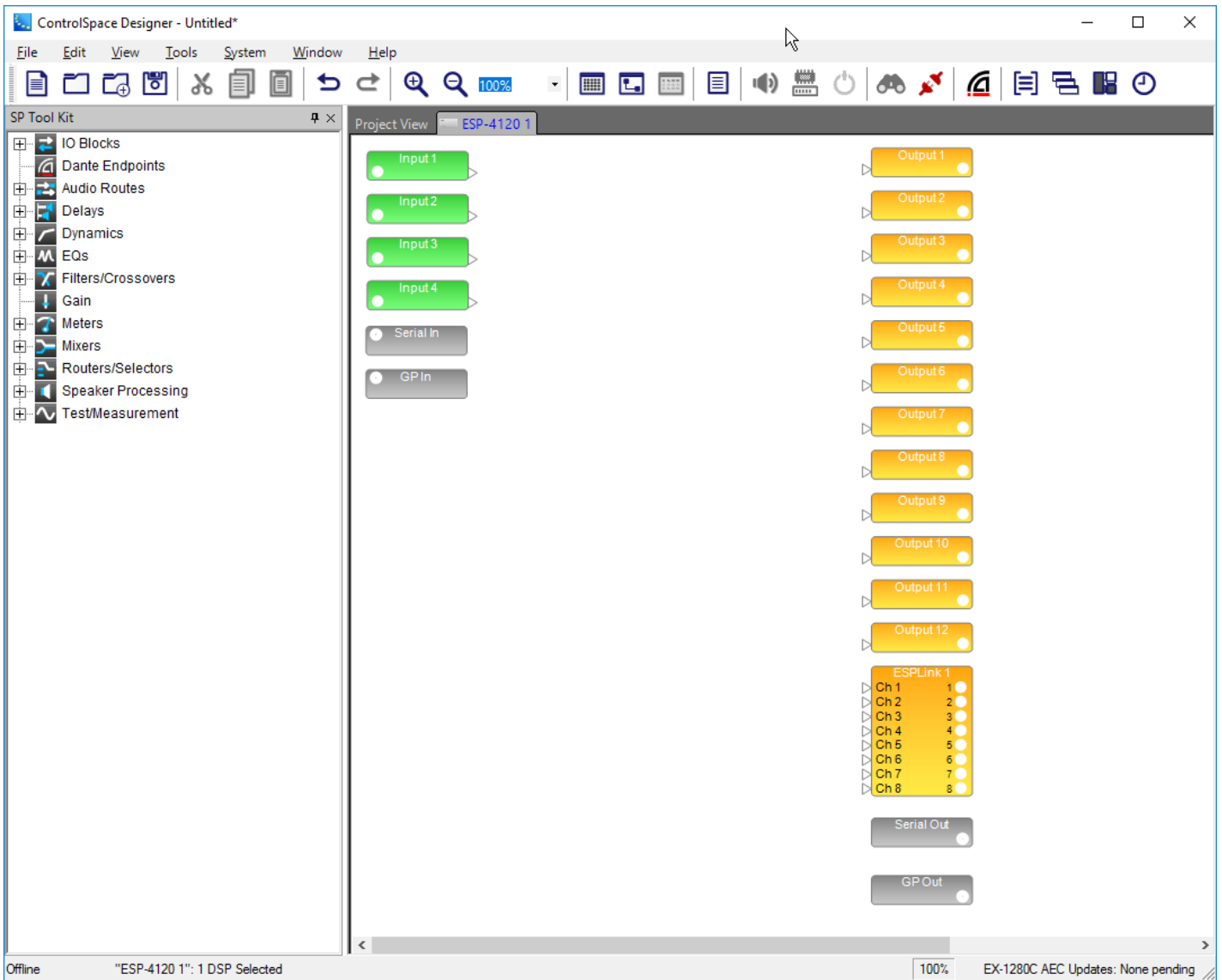

ESP-4120 Device tab selected showing SP Tool Kit and Signal Processing View

Some devices, such as the PM8250N below, have a fixed, non-configurable, signal processing diagram. When the Signal Processing View for a fixed block diagram device is active the SP Tool Kit is empty indicating that no additional signal processing may be added to this device.

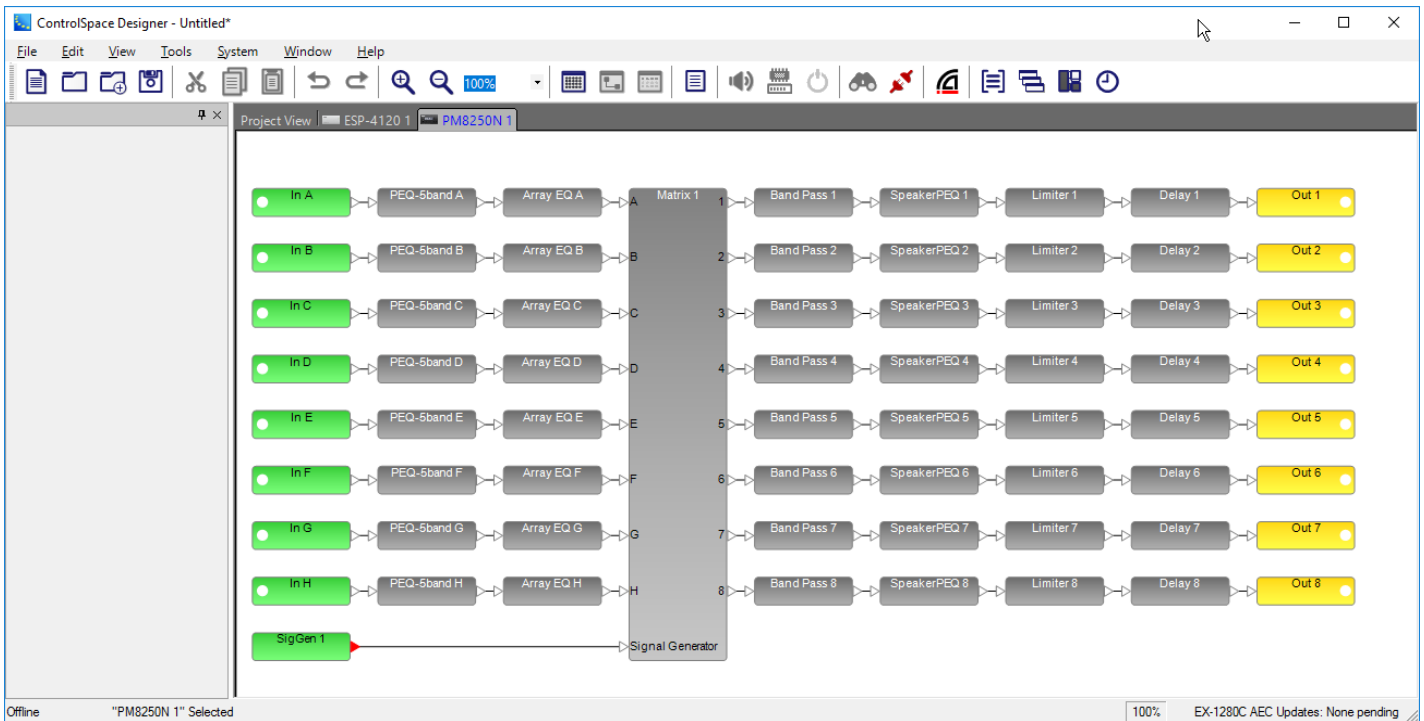

PM8250N Signal Processing View

Control Library

Control Library Functions

A ControlSpace system may be controlled through a variety of methods - ControlSpace Control Centers, general purpose interfaces, serial data control, etc. The commands issued by the control devices either directly control signal processing objects, such as a gain control, or trigger a state change to one or more signal processing devices.

The Control Library contains these types of control functions:

- **Parameter Sets**
- **Groups**
- **RCGroups**
- **Timers**

Access the Control Library from the Window menu. From here, you can open the Parameter Sets, Groups, RCGroups, Timers, and Presets windows.

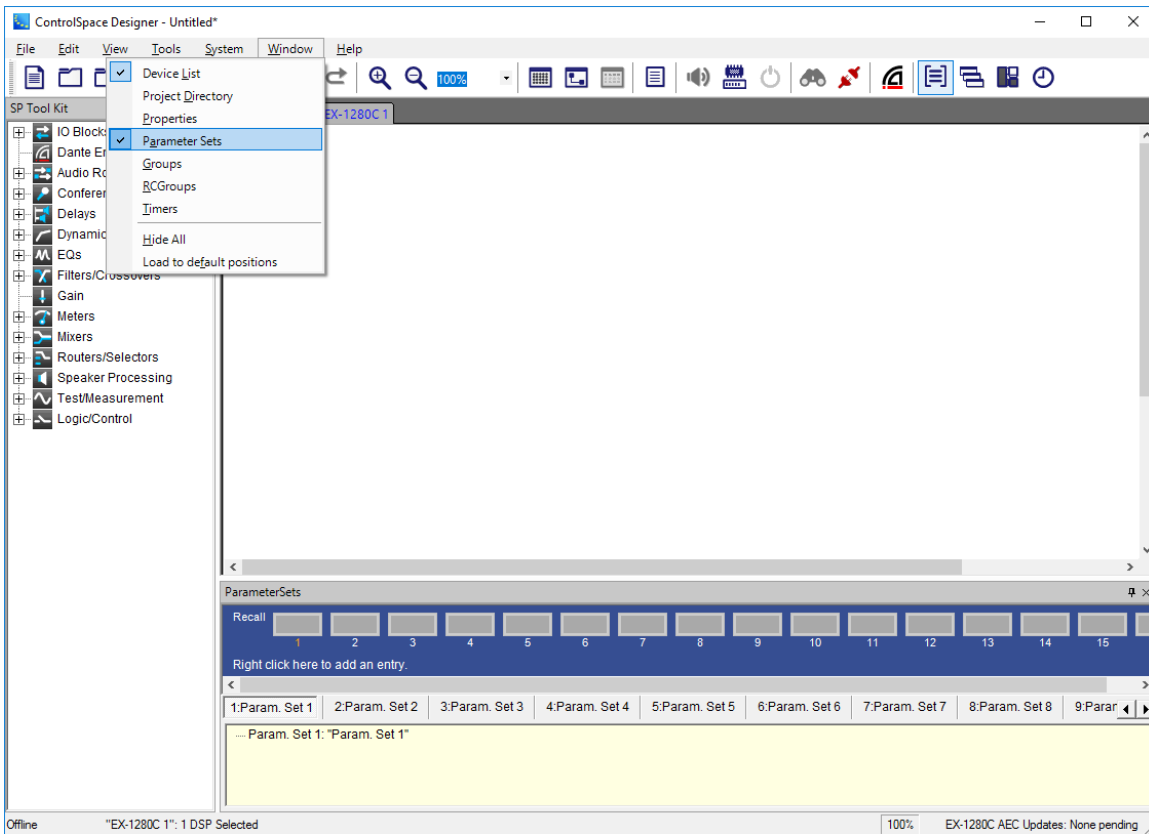

Control **programming** is done by dragging and dropping CSD objects or blocks. For example, to control two input gains using a single master gain, select the two input gains within the Signal Processing View, and then drag them to the next available Group within the Group Tab of the Control Library.

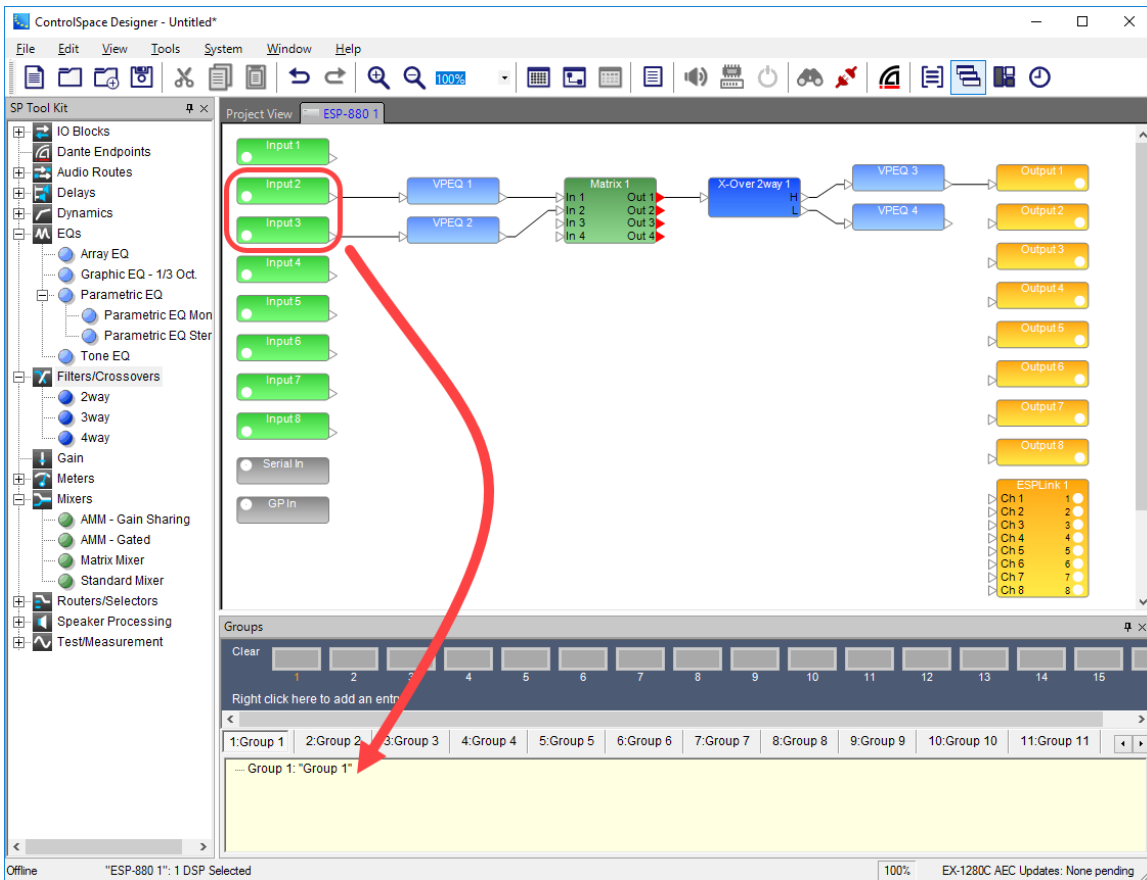

Parameter Sets Window

Parameter sets store the current state of selected devices or signal processing blocks. When recalled, the saved state is restored. All programming associated with parameter sets is stored within the ControlSpace Project file. Once the file is uploaded to the system, parameter set programming is stored within individual system devices.

To create new and view active parameter sets, select **Parameter Sets** from the **Window** menu.

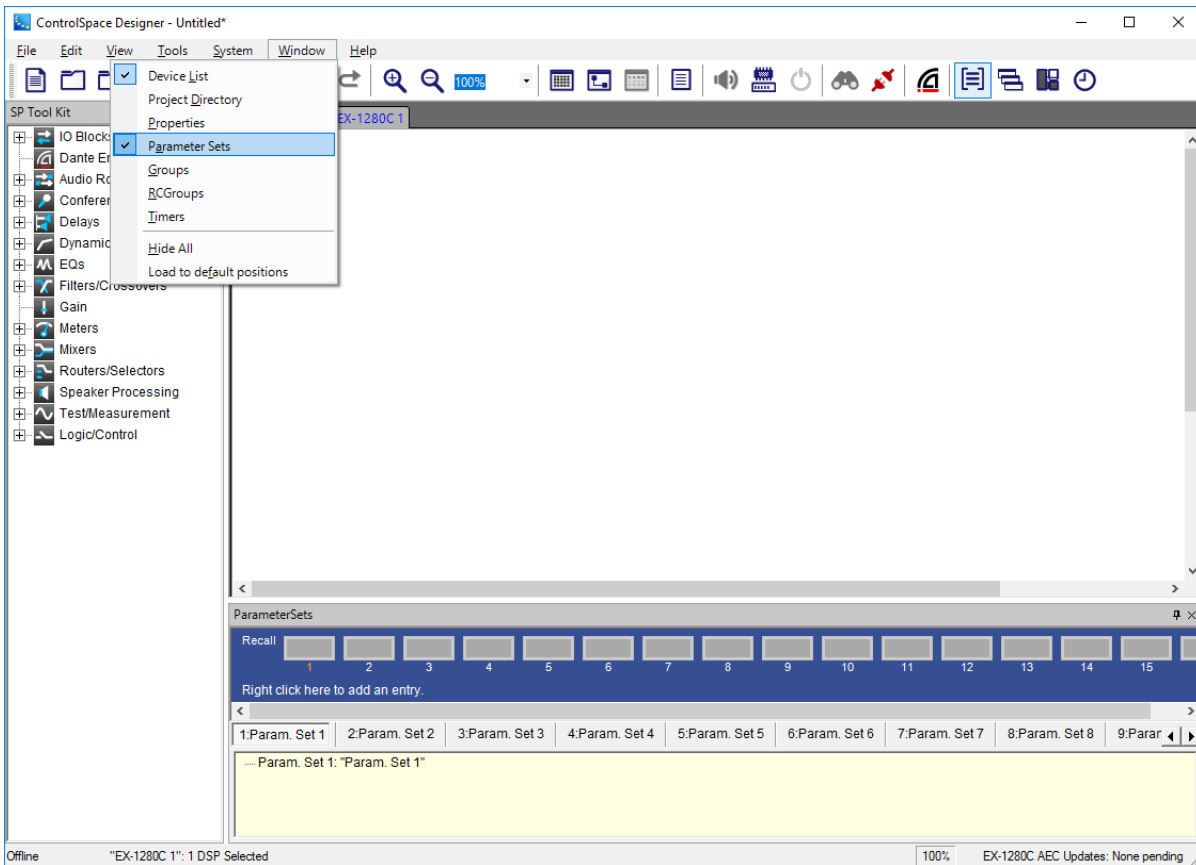

Parameter set programming is accomplished using drag and drop. Individual devices, signal processing objects or object properties may be dragged to a specific parameter set. When the parameter set is invoked, or recalled, the state of the object at the time of programming will be restored.

From within the Parameter Sets window the following functions are available:

Recall Parameter Set – Selecting this item recalls the stored parameter set settings.

Add Parameter Set – Right-click anywhere on the blue area of the Parameter Set window to add a new parameter set.

View Parameter Set – Select the desired parameter set name to view the device settings associated with the parameter set.

Edit Parameter Set – Expand the tree view of the selected parameter set to view and edit device settings.

Double-clicking on the top level of the tree view for a parameter set will display the Parameter Set Node List. This tree view shows all available system devices and their settings available to be used within a parameter set. Selected items are those that are included within the parameter set.

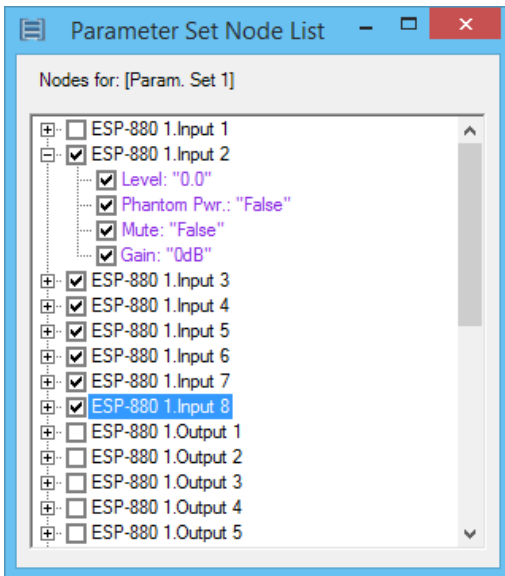

NOTE: It is possible to streamline Parameter Set programming by only including those device settings which will be affected by the Parameter Set. For example, when including an output gain change in a parameter set, the mute property can be removed. This simplifies programming and reduces file size in systems with a large number of parameter sets.

Parameter Set Lists Window

A parameter set list is a collection of multiple parameter sets (described in ["Parameter Sets" on page 427](#)) consolidated under a single node. You can place a parameter set list on a control center (CC) block and arrange its parameter sets in the desired order.

Each parameter set list keeps track its most recently recalled parameter set, enabling CCs to display the system's status even when different groups of parameter sets control different aspects of the system.

Note: A parameter set can belong to only one parameter set list at a time.

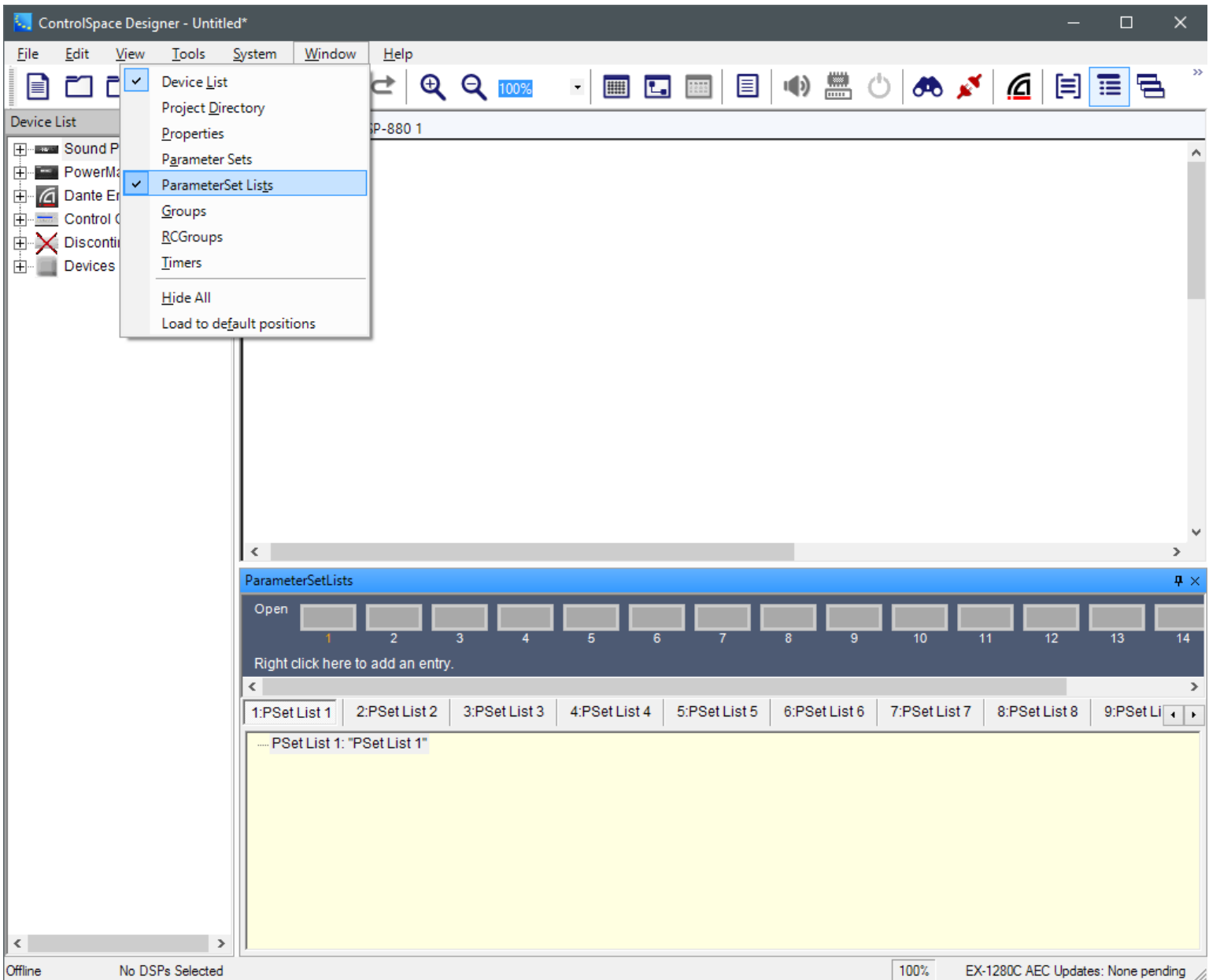

To show or hide the **Parameter Set List** window, do one of the following:

- Click the second icon in the last group of icons in the toolbar.

- Click **Window** and select **ParameterSetLists**.

- Right-click the top of any visible window in the project (**Device List**, **Project Directory**, etc.) and select **ParameterSetLists**.

Parameter set list programming is accomplished using drag and drop. Parameter sets may be dragged from the Parameter Set window to a specific parameter set list.

See [Control System Devices > Control Library > Parameter Set Lists](#) to learn more.

Groups Window

Groups provide for the control of multiple like control panels from a single control. An effective use of groups is the combining of multiple gains into a single master gain, or multiple crossovers into a single group crossover.

When creating groups it is important to remember that only like processing blocks may be grouped to a single control.

To create new and view active Groups, select **Groups** from the **Window** menu.

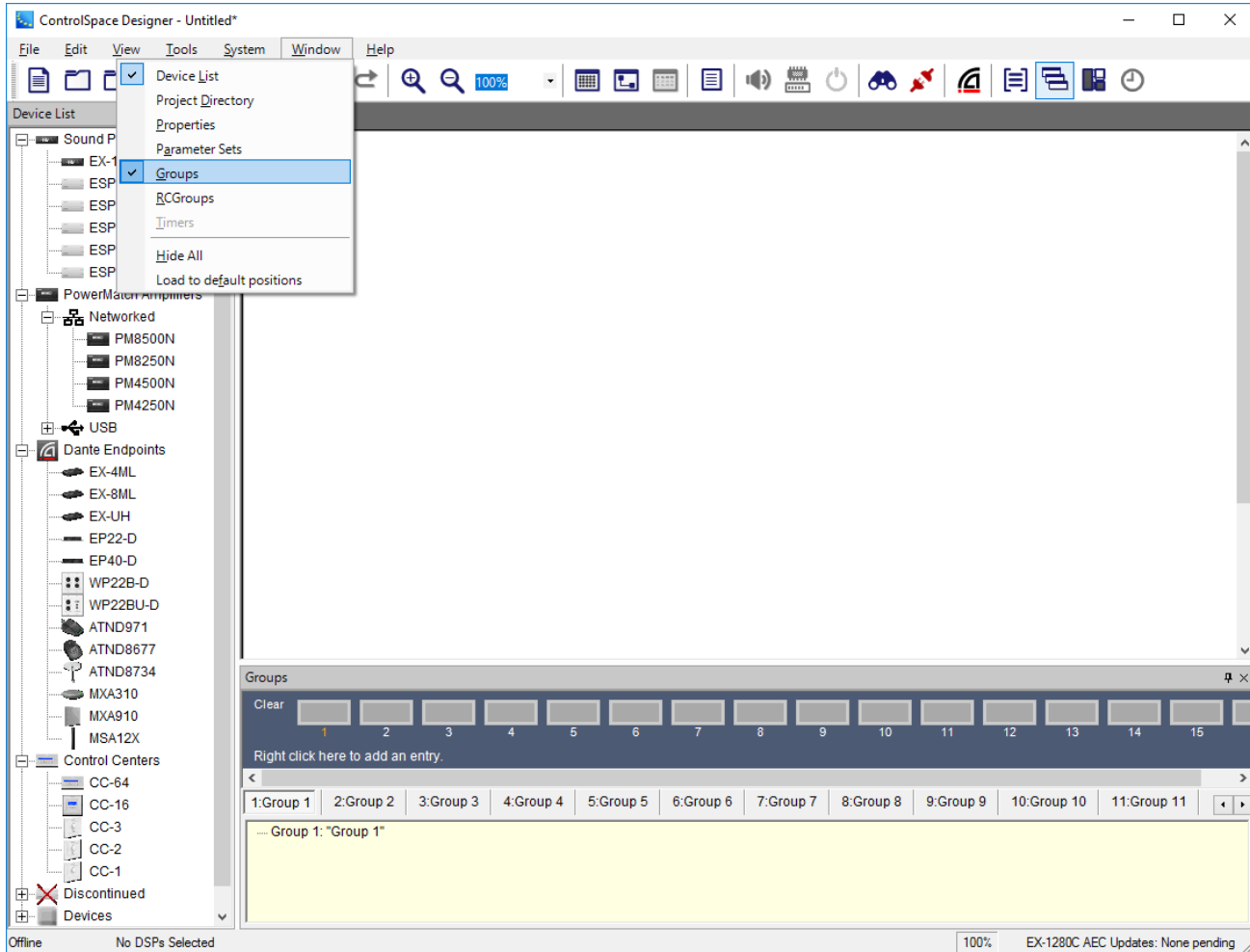

Group programming is accomplished using drag and drop. Multiple signal processing objects of the same type, input gains, output gains or gain blocks may be dragged to a specific group. When a Gain group is invoked, a master gain control will be displayed. Signal processing groups operate using linked controls – changes made to any one member of the group are reflected in all members.

From within the Groups window, the following functions are available:

- Clear Group** – Selecting this item removes all signal processing devices or gains from the selected group.
- Add Group** – Right-click anywhere on the blue area of the Groups window to add a new group.
- View Group** – Select the desired group name to view the signal processing devices or gains associated with the group. Double click on the top level of a gain group’s tree view to display the master volume control panel.
- Edit Group** – Expand the tree view of the selected group to view and edit its settings.

RCGroups Window

RCGroups (or Room Combine Groups) allow you to combine conference rooms by adding Conference Room Router (CRR) blocks to an RCGroup, one CRR per room added. Up to six CRR blocks per RCGroup are supported. For more on combining rooms, see [Configuring Combined Rooms](#).

To create new and view active RCGroups, select **RCGroups** from the **Window** menu.

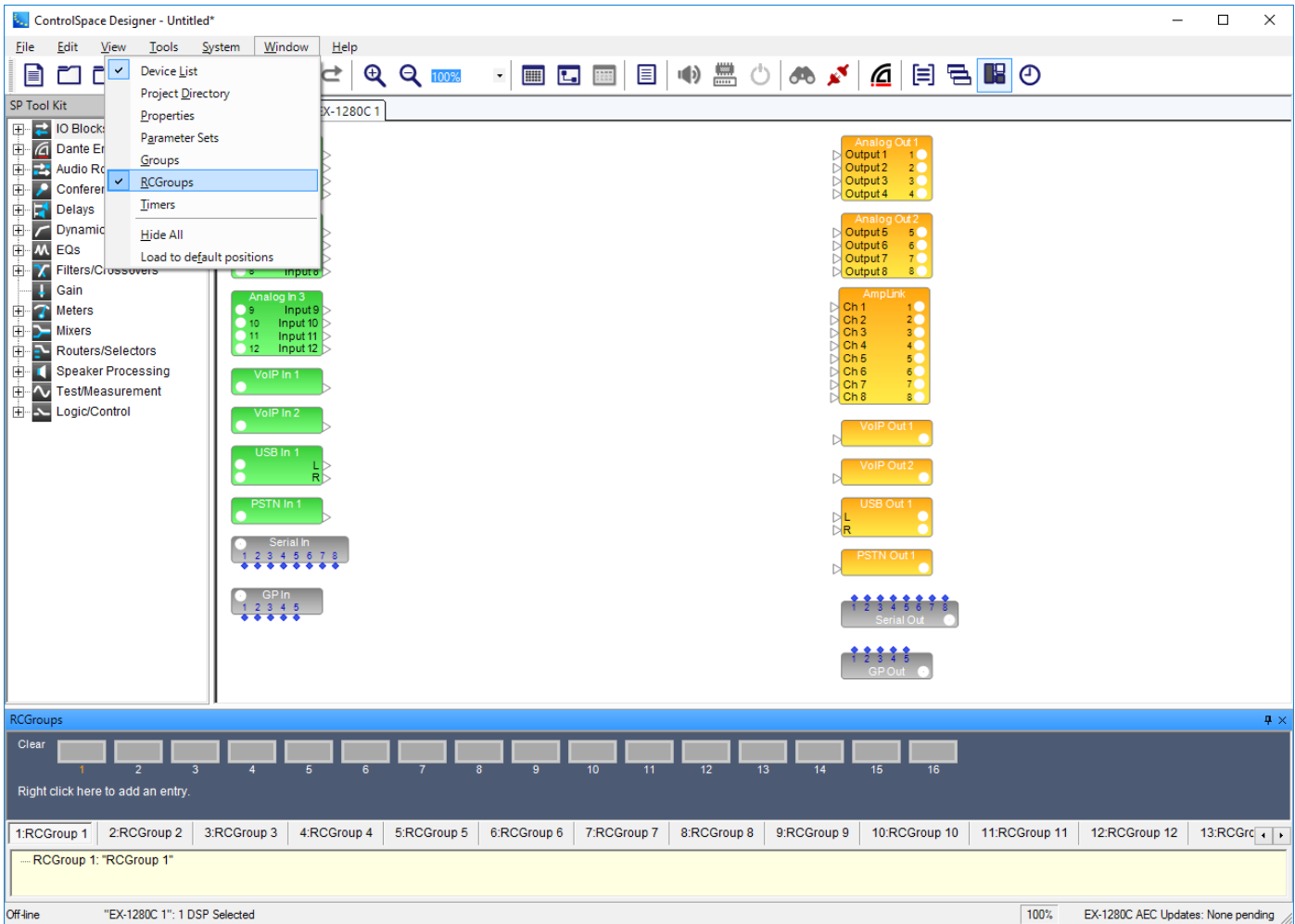

RCGroups Window

RCGroups programming is accomplished using drag and drop. Multiple CRR blocks may be dragged to a specific RCGroup.

From within the RCGroups window, the following functions are available:

- Clear RCGroup** - Click on the Clear block corresponding to the RCGroup number. This removes all CRR blocks from that RCGroup, but does not delete the RCGroup itself.
- Add RCGroup** - Right-click anywhere on the blue area of the RCGroups window to add a new RCGroup.
- View RCGroup** - Select the desired RCGroup name to view the CRRs associated with the RCGroup.
- Edit RCGroup** - Expand the tree view of the selected RCGroup to view and edit its settings.

Timers Window

Timers are used to invoke a specific signal processor state, or Parameter Set at a specific day or time. Timers are only available when the system includes an ESP or EX-1280C signal processor.

To create new and view active Timers, select **Timers** from the **Window** menu.

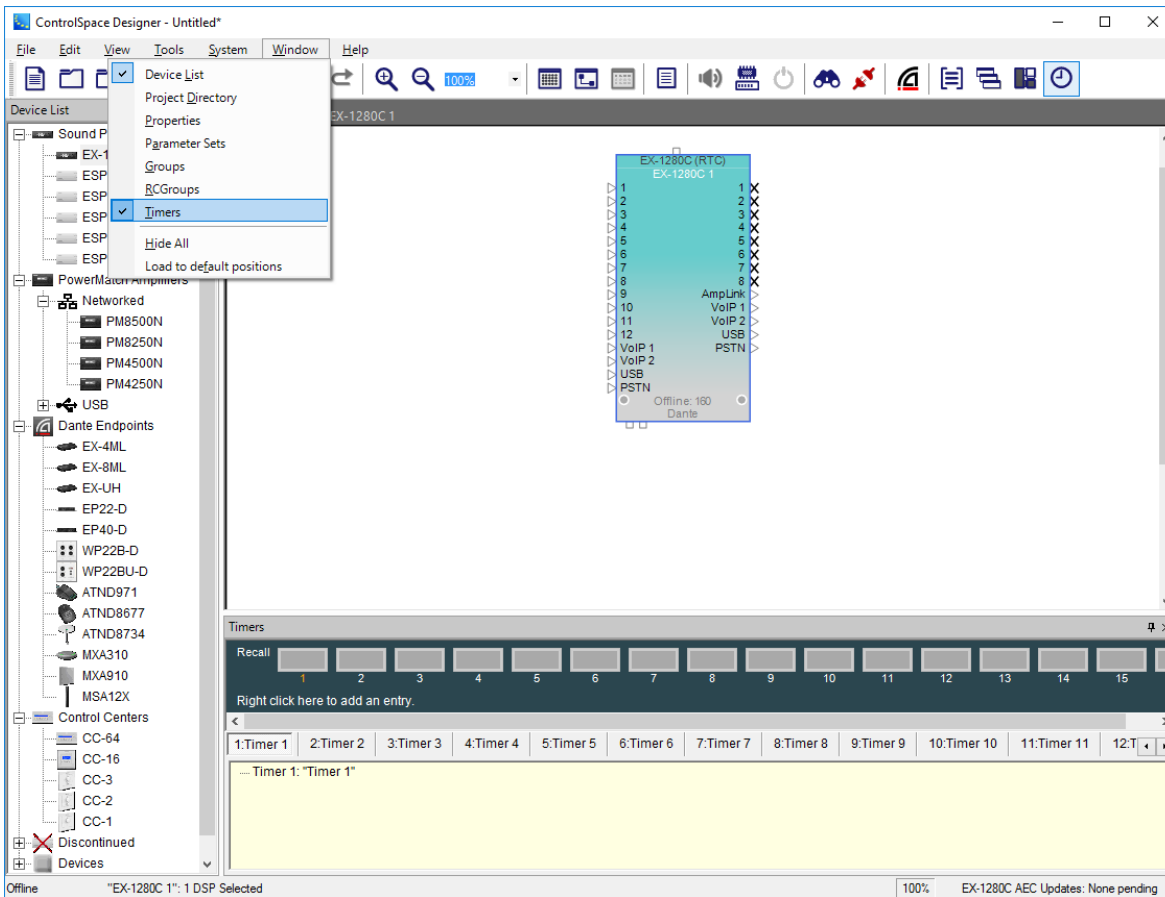

Timer programming is accomplished using drag and drop. Individual signal processing blocks, block properties or parameter sets may be dragged to a specific timer. When the timer is invoked, or recalled, the state of the object at the time of programming will be restored.

From within the Timers window, the following functions are available:

Recall Timer - Selecting this item recalls the settings associated with the timer.

View Timer - Select the desired timer name to view the signal processing blocks or parameter sets associated with the timer. Double click on the top level of a timer's tree view to display the settings for this timer.

Edit Timer - Expand the tree view of the selected timer to view and edit its settings.

When an object is initially dragged and dropped on a timer, the Timer Settings window appears. This displays the timing and recurrence settings for the individual timer:

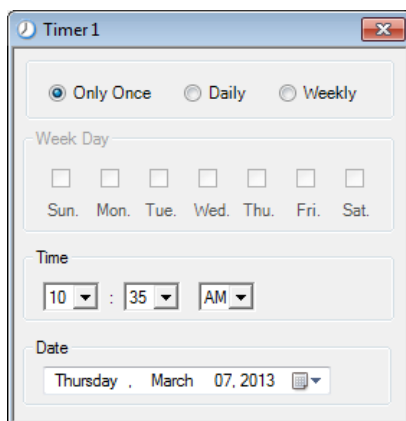

Recurrence - Determines the frequency of the timer. Available options are **Only Once**, **Daily** or **Weekly**.

Week Day – Determines the day or days of the week when the timer is active. This option is only available when the **Recurrence** is set to **Weekly**.

Time – Determines the time of day when the timer will be invoked.

Date – Determines the date the timer will occur. This option is only available when the **Recurrence** is set to **Only Once**.

Project Directory

An advanced method to program a system is to use the Project Directory. The Project Directory is the master directory of all components, signal processing objects, and control functions in the system design. Visibility to all devices, signal processing blocks, inputs, outputs, control centers, and programming functions is provided in this single location.

To access the Project Directory, select **Project Directory** from the **Window** menu.

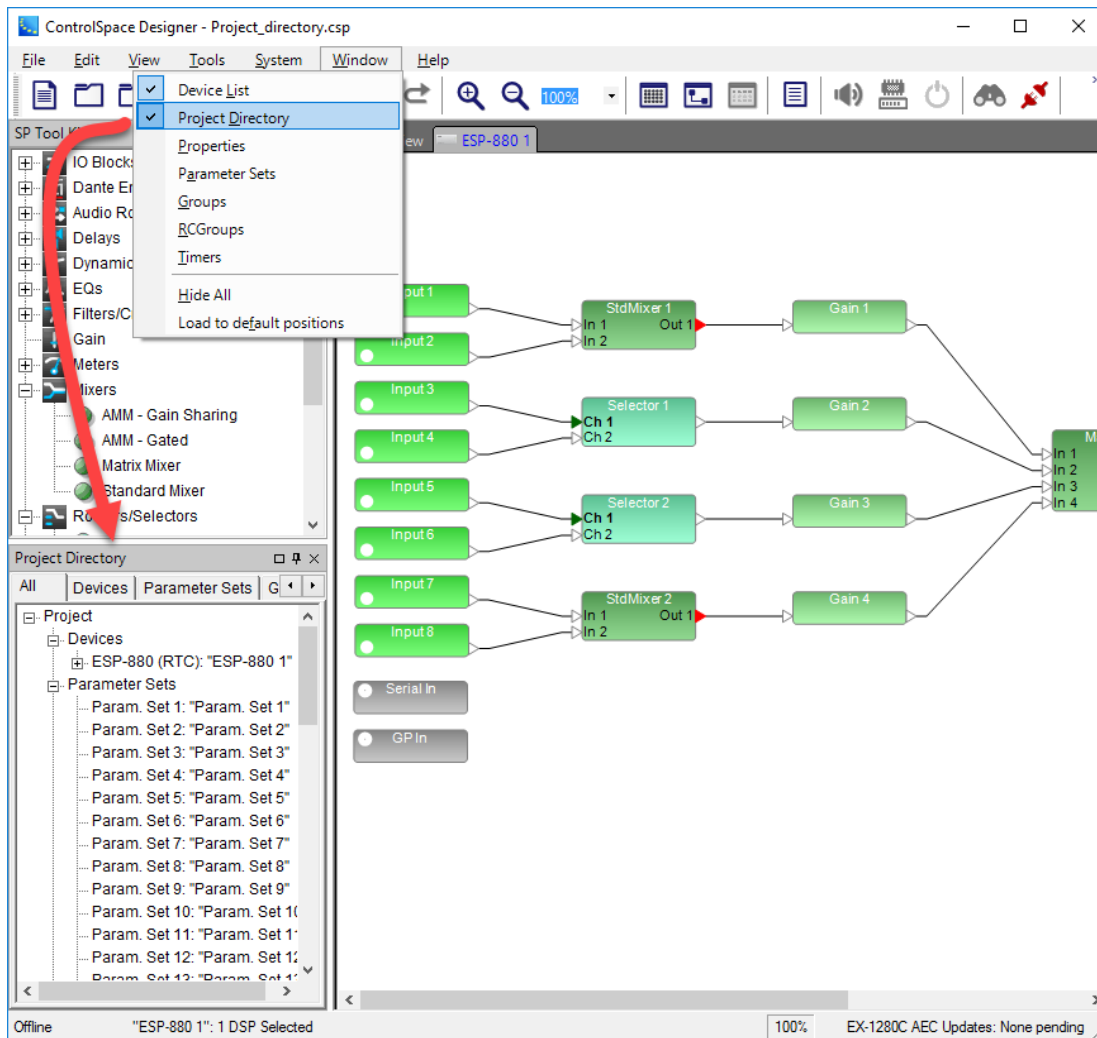

Project Directory window

Use the tabs at the top of the project directory window to select a sub category of objects in your design. By default, the **All** tab is selected at the top of the project directory window to display all objects in your design. You may select different tabs to isolate sub categories of objects. For example, select the **Groups** tab to view all defined Groups in a design.

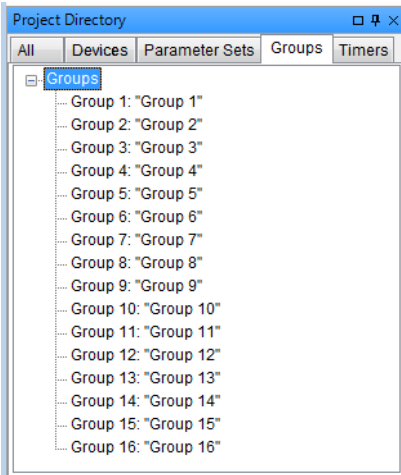

Groups tab of the Project Directory

The project directory window contains all objects in your system design and displays them in a tree structure. To see a particular object in your design, expand this tree structure until you reach the settings of interest. For example, to view the IP Address of a CC-64 Control Center, expand the directory to **Project > Devices > CC-64 > Property**.

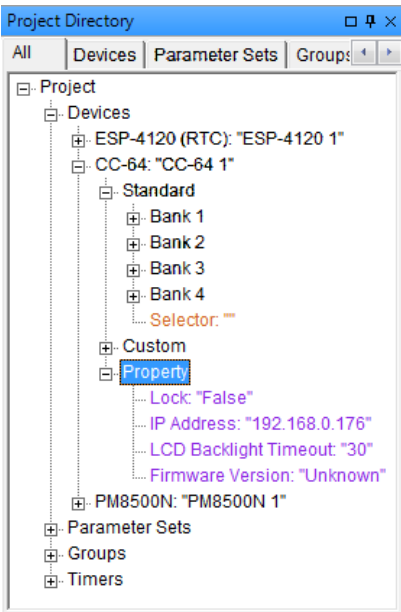

Project Directory tree expanded

You may program Parameter Sets, Groups, RCGroups, and Timers by dragging and dropping signal processing blocks from Signal Processing View into Project Directory locations. For example, to program a parameter set, select signal processing blocks and drag those into the parameter set tree structure.

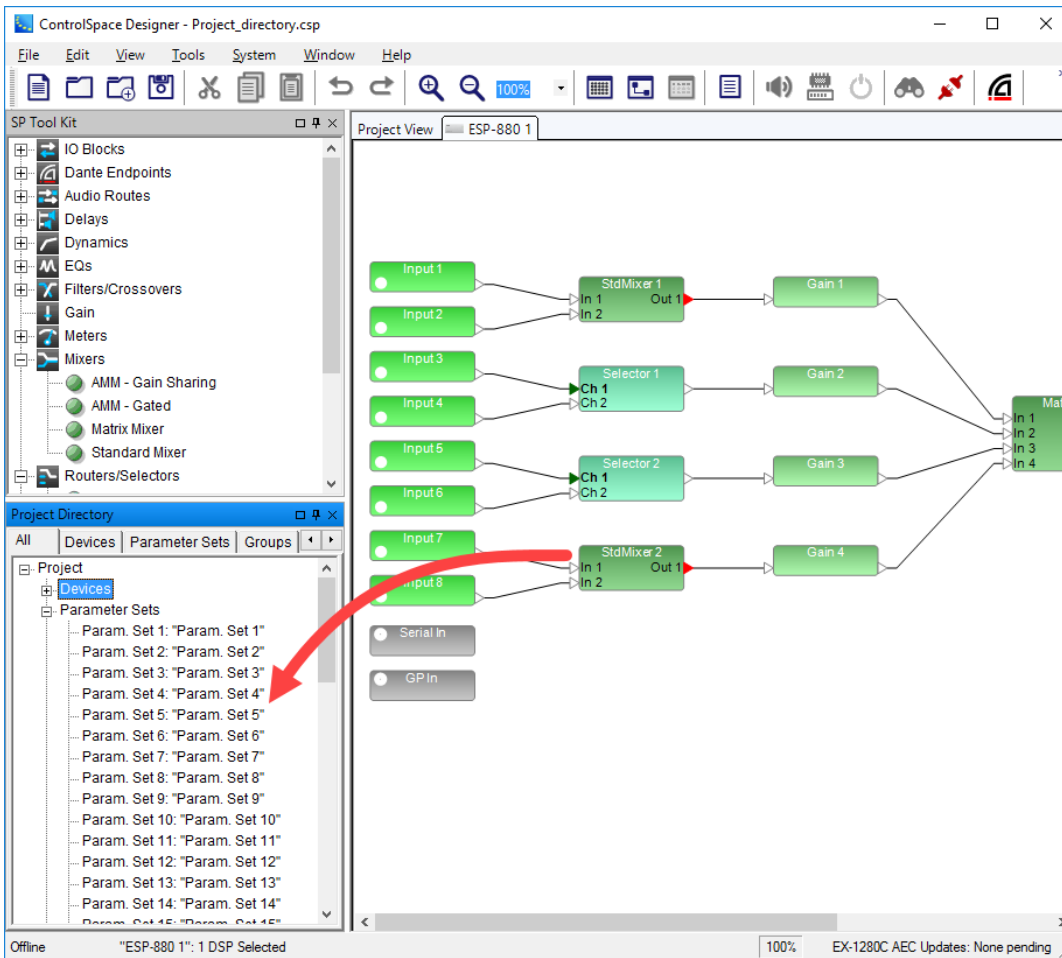

Drag and drop processing blocks into the Project Directory

You may also use the Project Directory to program user controls without opening the Smart Simulators or GPI control panels. For example, to access the CC-64 controls, select the **Devices** tab in the **Project Directory** window, then click on the **CC-64 > Standard**.

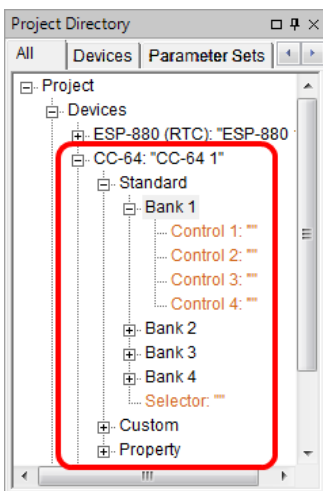

Accessing CC-64 controls in the Project Directory

Once the Project Directory window is open, you may drag and drop into the banked controls, Selector, and Custom controls just as you would with the CC-64 Smart Simulator.

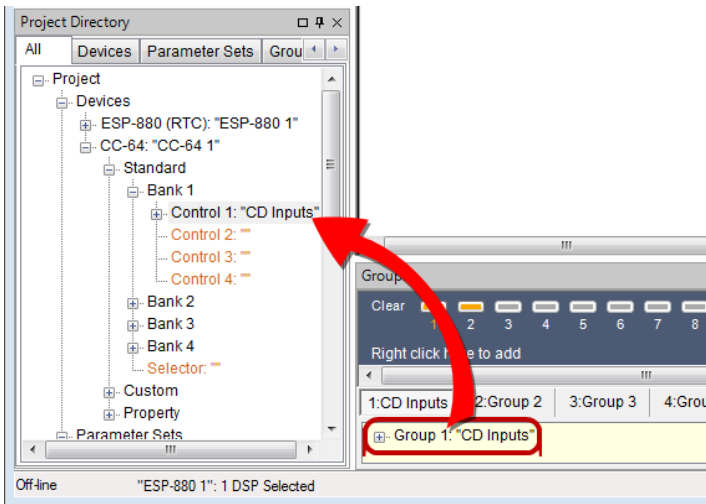

Assigning groups to CC-64 using the Project Directory

In the same manner, you may directly assign selector and gain functions to CC-16 controls using the **Project Directory** window.

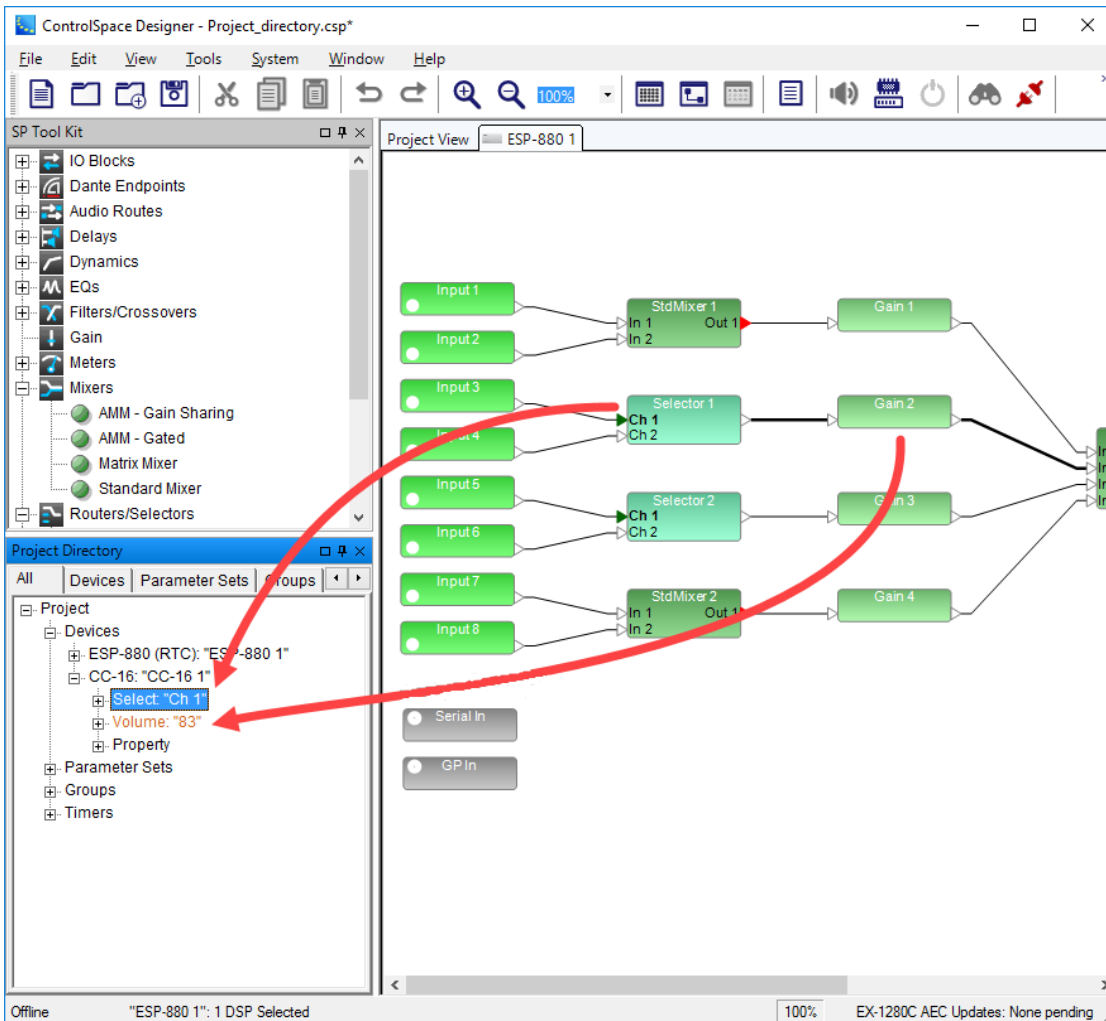

Assigning blocks to CC-16 using the Project Directory

NOTE: The position of CC-16 Zone Controller in the Project Directory is dependent on the ESP or EX-1280C to which it is connected. Before a wiring connection is made from a CC-16 to its associated signal

processing device in the Project View, it appears in the top level of the Devices tree. After a wiring connection is made to a signal processing device, each CC-16 appears within its associated device's (ESP or EX-1280C) tree structure.

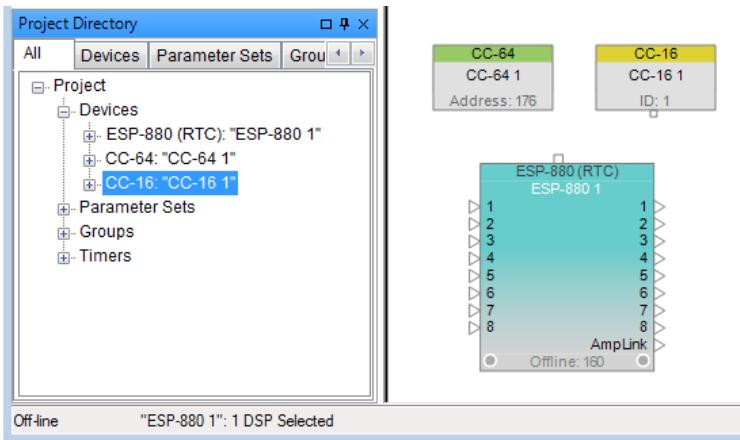

CC-16 "Unconnected" Position within the Project Directory

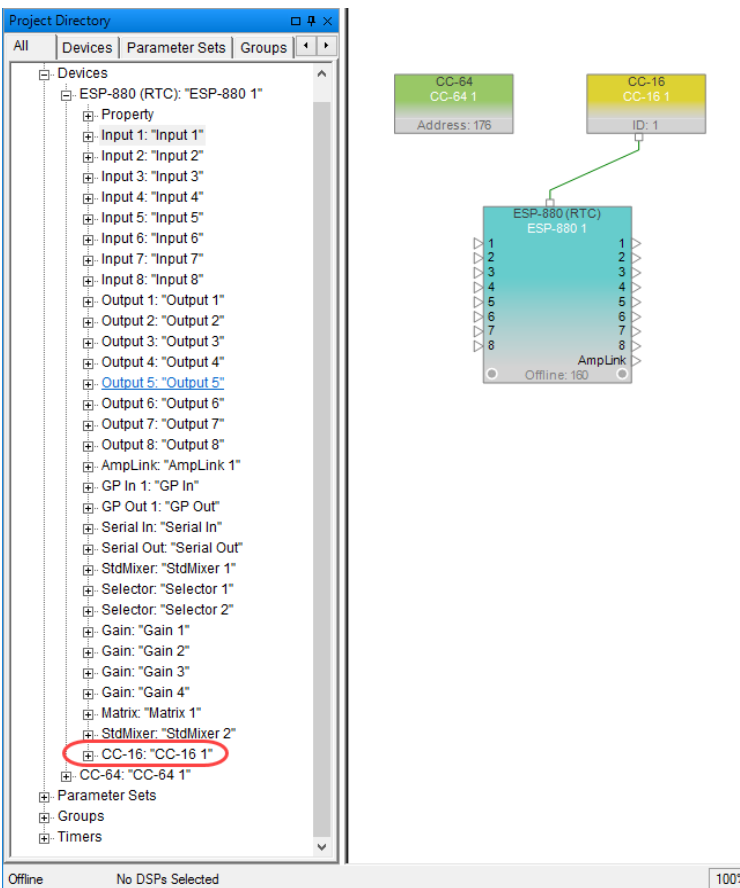

CC-16 "Connected" Position within the Project Directory

Properties Window

The Properties window allows you to view and update settings for a selected object without opening its control panel. Open the Properties window by selecting **Properties** from the **Window** menu.

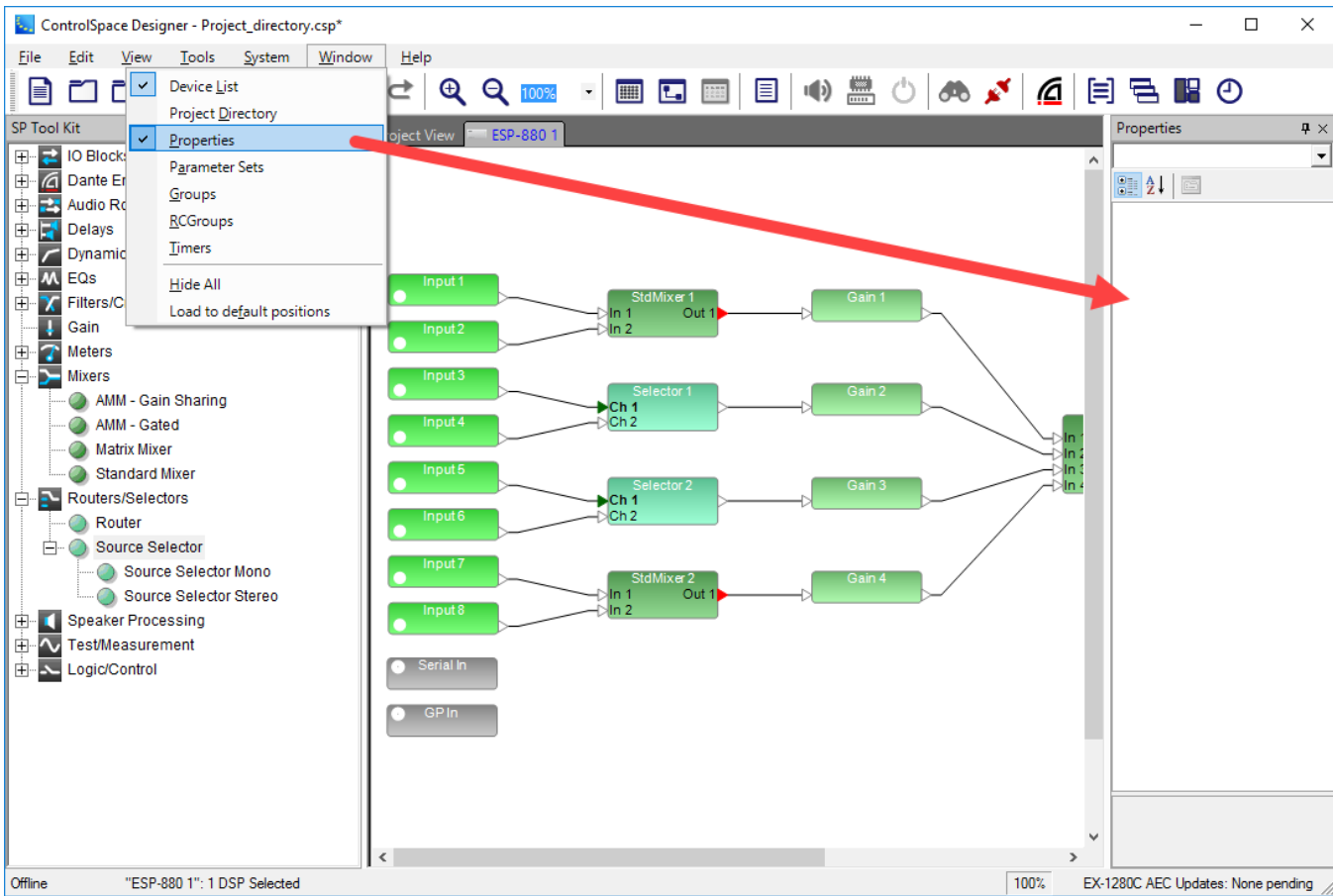

Properties Window

Once the Properties Window is open, select an object in **Project** or **Signal Processing** Views to see all its properties. You may also use the drop-down menu at the top of the Properties window to select a different device.

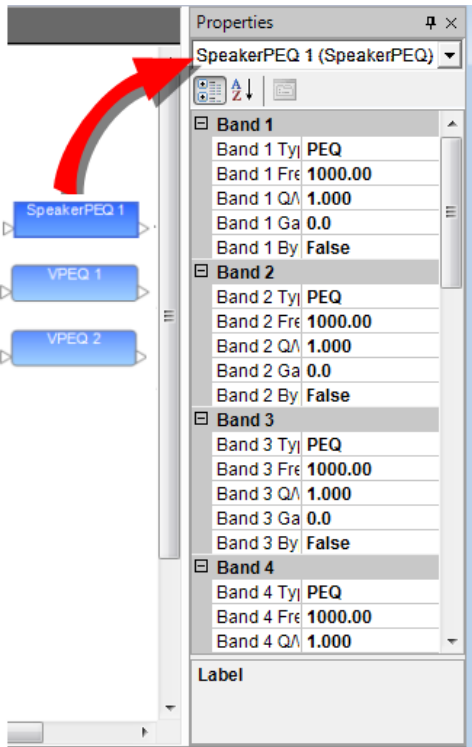

Viewing selected block properties

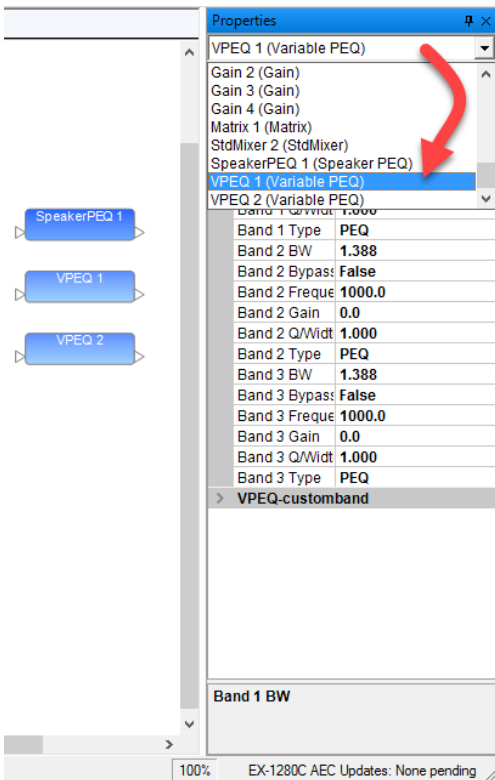

Selecting a different block

The Properties window may be used to change card assignments or any other setting for an ESP or EX-1280C within Project View. For card assignments, select the ESP icon, and then choose a new card for the desired slot in the **Properties** window.

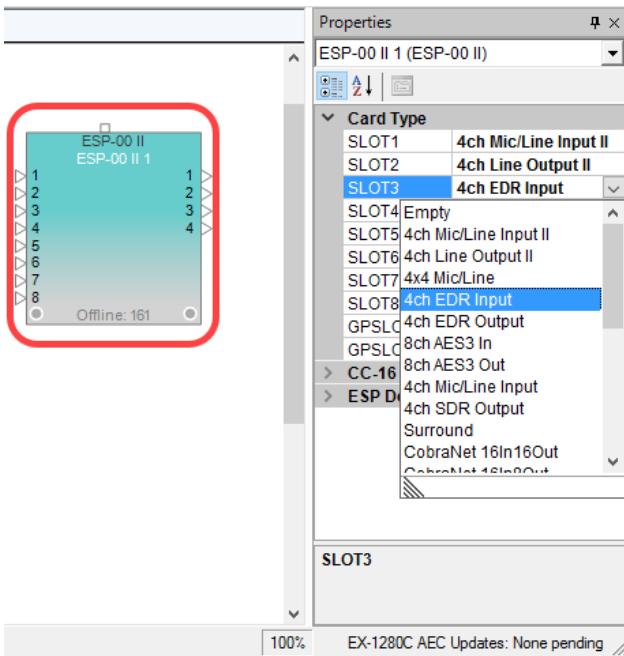

Adjusting ESP Card Assignments in the Properties Window

You may also adjust control panel settings using the Properties window. Select the desired control panel to view or change its properties within the **Properties** window.

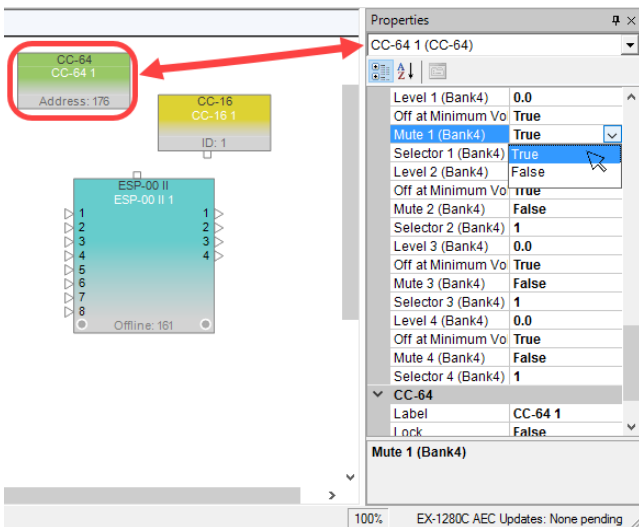

Adjust CC-64 Settings within the Properties Window

Blocks within **Project**, **Signal Processing**, or **PowerMatch** views are equally accessible using the Properties Window. Simply select the desired object to view or change its properties within the **Properties** Window.

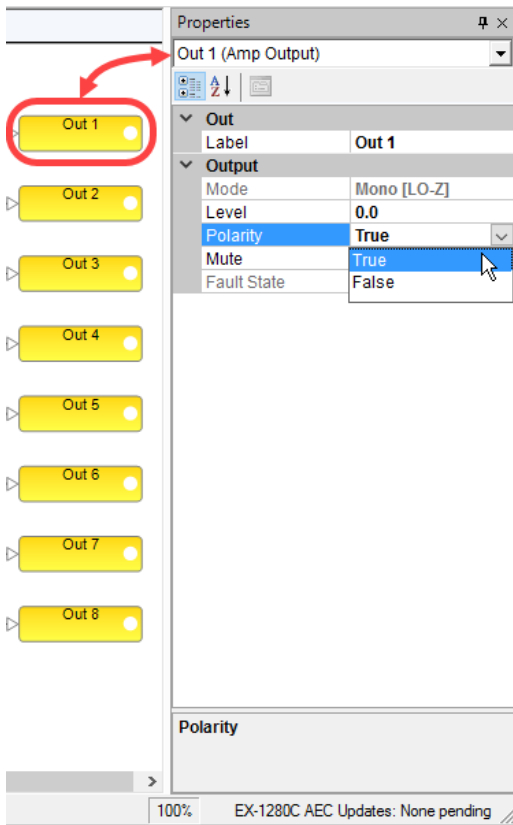

Adjust PowerMatch Settings within the Properties Window

Window Controls

All major windows within the ControlSpace[®] Designer™ interface may be configured as either floating, docked, or docked, but minimized. By default, windows, when made active, are docked.

Floating Windows

To float a window within the application, click on the title bar and drag the window to another location within the application. Windows, when floated, may be placed anywhere on the monitor area.

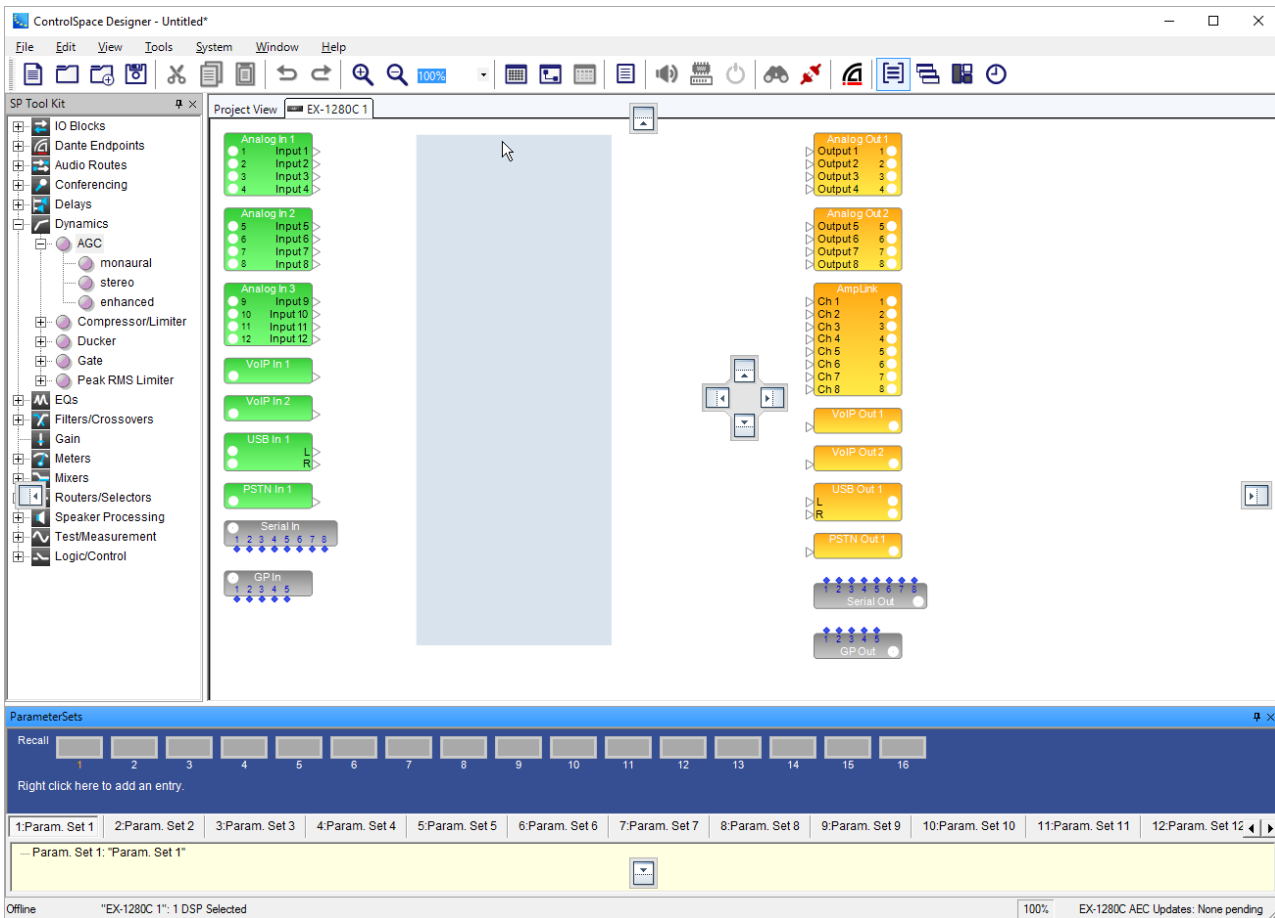

Docking Windows

Windows may be docked anywhere along the edges of the main application window. To dock a floating window drag and drop the window on any of the docking targets along the edge of the application window.

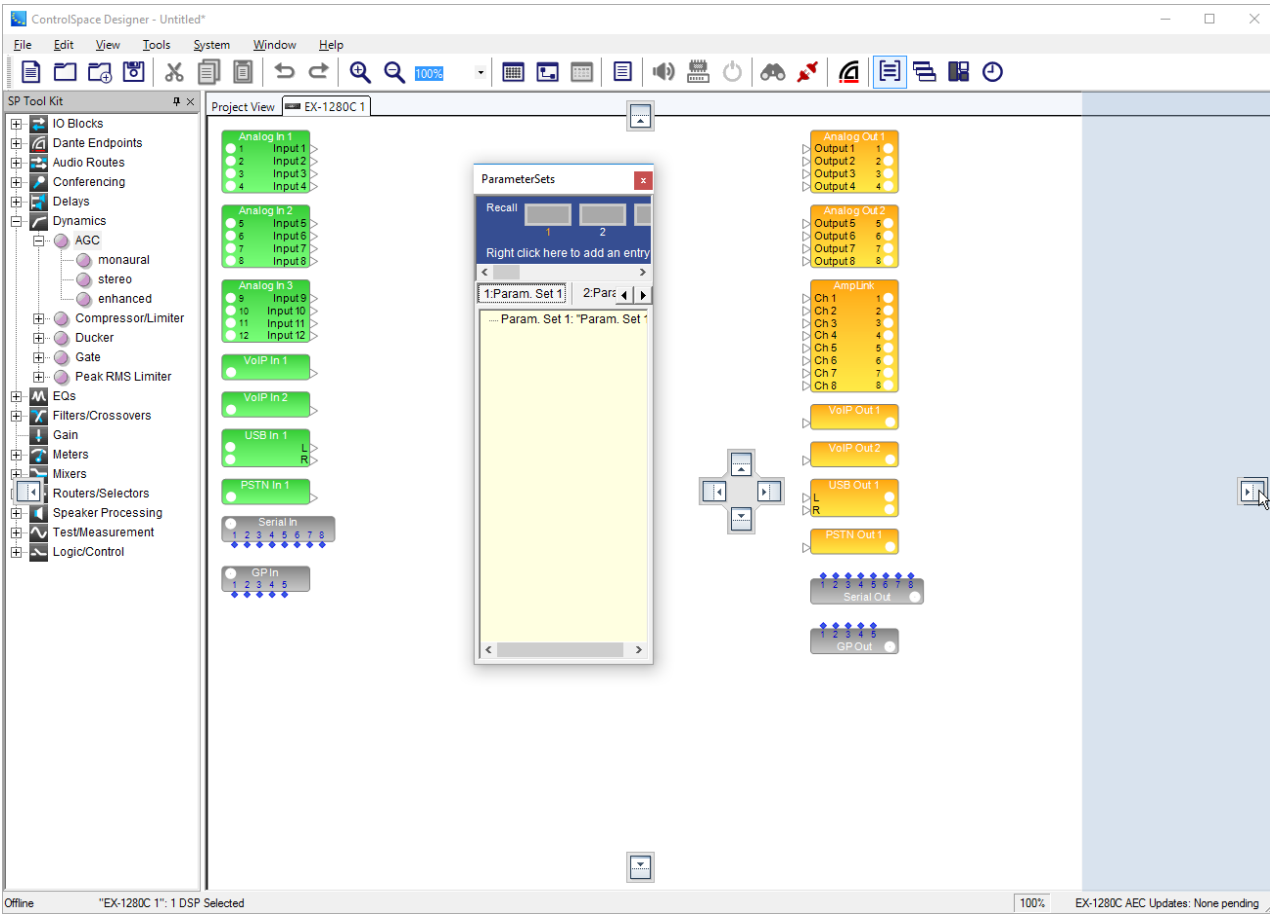

Minimizing Docked Windows



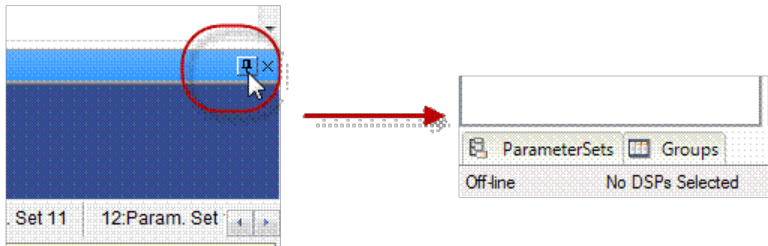

A docked window may be minimized using the Pin tool located in the upper right section of the window's title bar. When selected the window is minimized to a tab along the edge of the application window.



When minimized, selecting the tab will cause the window to be temporarily maximized.

Menus Reference

File Menu





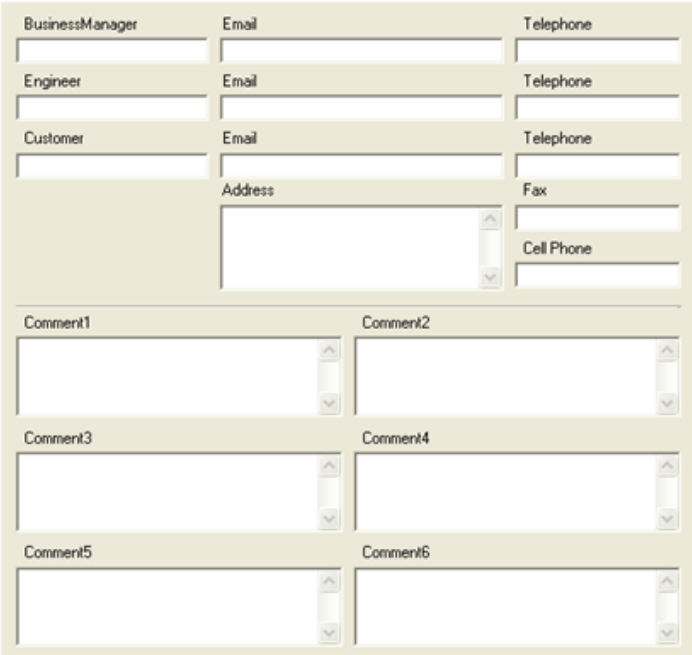
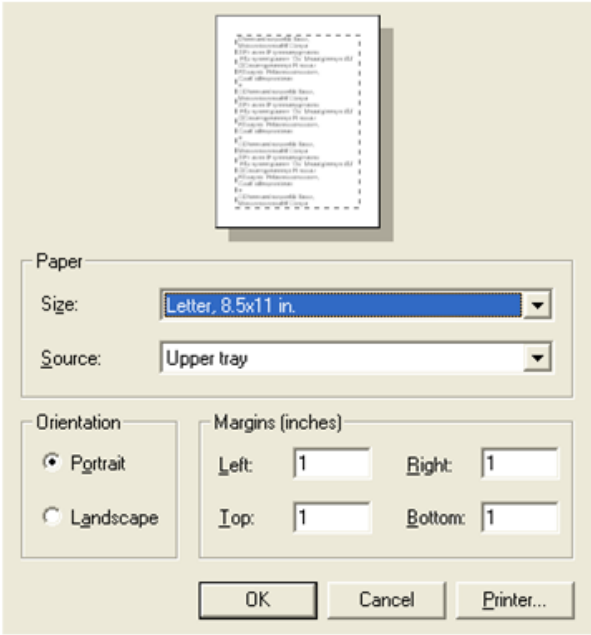

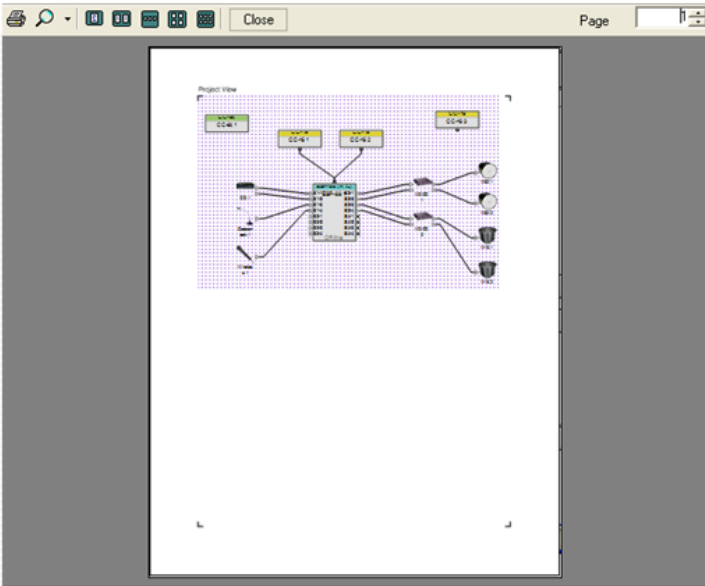
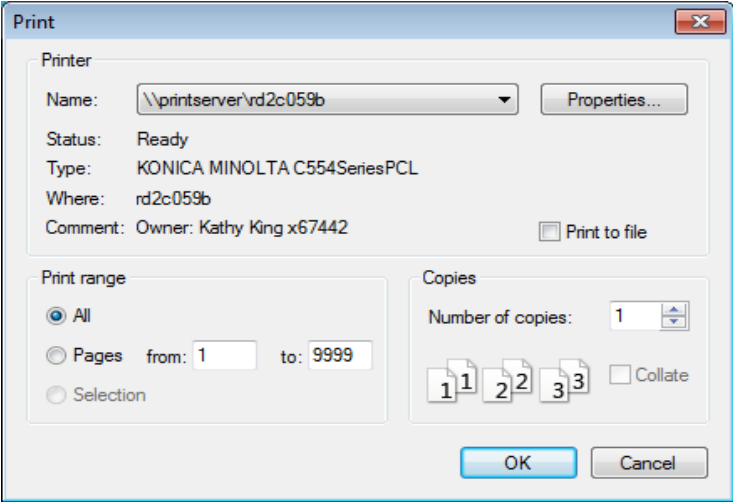
	<u>N</u> ew	Ctrl+N
	<u>O</u> pen	Ctrl+O
	<u>M</u> erge Projects	Ctrl+M
	<u>S</u> ave	Ctrl+S
	Save <u>A</u> s...	
	<u>E</u> xport...	Ctrl+E
	Project <u>I</u> nformation...	Ctrl+I
	Page Setup...	
	Print <u>P</u> review...	
	<u>P</u> rint...	Ctrl+P
	<u>R</u> ecent Files	
	<u>E</u> xit	Alt+F4

Function	Description
New	Creates a new project file (.CSP). If a project is currently open and unsaved, you will be prompted to save it before creating a new project.
Open	Allows you to open an existing project (.CSP) file. If a project is currently open with unsaved changes, you will be prompted to save it before opening a new project.
Merge Projects	Allows you to open a project file and merge it with the currently open project file.
Save	Saves changes to the project. If you have not yet saved the project, you will be prompted to name and save the project.
Save As	Creates a copy of the project and saves it with a different name. The new saved project will remain open and the original project will be closed.
Export	Exports the contents of your project to a comma delimited (.CSV) file. This file contains the entire tree structure of your project, similar to the Project Directory window.

Function	Description
Project Information	 <p>Opens the Project Information window, where you can record contact information and comments related to the design. For more information, see Adding Project Information.</p>
Page Setup	 <p>Opens the Page Setup window for print output, where you can change the paper size, printer paper source, orientation, and margin sizes.</p>

Function	Description
<p>Print Preview</p>	 <p>Opens the Print Preview window to view what your design will look like when printed.</p>
<p>Print</p>	 <p>Opens the Print window to select a printer, specify which pages to print, and the number of copies.</p>
<p>Recent Files</p>	<p>Lists the four most recently active projects. Select one to open the project file.</p>
<p>Exit</p>	<p>Closes ControlSpace Designer software. If a .CSP file is open, you will be prompted to save changes.</p>









Edit Menu

	U <u>ndo</u>	Ctrl+Z
	R <u>edo</u>	Ctrl+Y
<hr/>		
	Cu <u>t</u>	Ctrl+X
	C <u>o</u> py	Ctrl+C
	P <u>a</u> ste	Ctrl+V
	D <u>u</u> plicate	Ctrl+D
	C <u>o</u> py Param <u>e</u> ters	Ctrl+G
	P <u>a</u> ste Param <u>e</u> ters	Ctrl+R
	D <u>e</u> lete	Del
<hr/>		
	Select <u>A</u> ll	Ctrl+A
<hr/>		
	Bring Selection to <u>F</u> ront	Ctrl+F
	Send Selection to <u>B</u> ack	Ctrl+B
<hr/>		
	Align <u>L</u> eft Sides	
	Align Horizontal Centers	
	Align <u>R</u> ight Sides	
	Align <u>T</u> ops	
	Align <u>V</u> ertical Centers	
	Align <u>B</u> ottoms	

Function	Description
Undo	Undo your last action or undo multiple actions for each Project View Tab.
Redo	Redo your last action (after undo) or redo multiple undo actions up to the most recent action within the selected Project View Tab.
Cut	Deletes the selected item and copies it to the clipboard (standard Windows editing function).
Copy	Copies the item to the clipboard (standard Windows editing function).
Paste	Pastes the contents of the clipboard (standard Windows editing function).
Duplicate	Copies <i>and</i> pastes the selected item, in effect cloning it (standard Windows editing function).
Copy Parameters	Copies the parameters, or settings, for an SP block in the Signal Processing View. The parameters can be copied to another SP block of the same type.
Paste Parameters	Pastes the copied settings from one SP block to one or more other blocks of the same type.
Delete	Deletes the selected item.

Function	Description
Select All	Selects all items in the active window.
Bring Selection to Front	Moves selected SP block or device up over any overlapping objects.
Bring Selection to Back	Moves selected SP block or device behind any overlapping objects.
Align Left Sides	Aligns the left sides of all selected blocks in Project View or Signal Processing View.
Align Horizontal Centers	Aligns the horizontal centers of all selected blocks in Project View or Signal Processing View.
Align Right Sides	Aligns the right sides of all selected blocks in Project View or Signal Processing View.
Align Tops	Aligns the tops of all selected blocks in Project View or the Signal Processing View.
Align Vertical Centers	Aligns the vertical centers of all selected blocks in Project View or Signal Processing View.
Align Bottoms	Aligns the bottoms of all selected blocks in Project View or Signal Processing View.

View Menu

	Zoom <u>I</u> n	Ctrl+1
	Zoom <u>O</u> t	Ctrl+2
	Zoom <u>N</u> ormal	Ctrl+3
	Zoom To <u>F</u> it	Ctrl+4
<hr/>		
	Show <u>G</u> rid	
	Hide All Logic I/O	
	Show Signal Processing Logic I/O	
	Hide All <u>W</u> ires	
	Hide <u>A</u> udio Wires	
	Hide <u>L</u> ogic Wires	
	<u>S</u> ystem Status	
	System Status Settings	▶
<hr/>		
	Wire <u>S</u> tyl	▶
	Wire Colors	
	Show Wiring <u>C</u> rosshair	
<hr/>		
	Over <u>v</u> iew	

NOTE: ESP sound processors do not support logic functionality.

Function	Description
Zoom In	Magnifies your view in the Design Workspace.
Zoom Out	Zooms the view out to show a larger area of the Design Workspace.
Zoom Normal	Sets the zoom level to 100%.
Zoom To Fit	Sets the zoom level so that all objects can be seen in Project View or in Signal Processing View.
Show /Hide Grid	Switches the background grid in Project View or in Signal Processing View between two different patterns, or hides grid. When grid is shown, any objects or blocks you place will align with (snap to) grid boundaries.
Show/Hide All Logic I/O	<p>Hide: Hides all Logic I/O ports and wiring for <i>all</i> EX-1280Cs in the design.</p> <p>Show: Shows only the Logic I/O ports and wiring for non-SP blocks (for example, serial I/O or GPI/GPO) for <i>all</i> EX-1280Cs in the design.</p> <p>Tip: To show Logic I/O for all SP blocks in all EX-1280C processors, select Show Signal Processing Logic I/O.</p>
Show/Hide Signal Processing Logic I/O	<p>Hide: Hides only the Logic I/O ports and wiring for SP blocks in <i>all</i> EX-1280Cs in the design.</p> <p>Show: Shows only the Logic I/O ports and wiring for SP blocks in <i>all</i> EX-1280Cs in the design.</p>
Show/Hide All Wires	Shows or hides all wiring for all blocks in the <i>selected</i> Device (processor) tab.
Show/Hide Audio Wires	Shows or hides only the audio wiring for all blocks in the <i>selected</i> Device (processor) tab.
Show/Hide Logic Wires	Shows or hides only the logic wiring for all blocks in the <i>selected</i> Device (processor) tab.
System Status	Displays the monitor panels for all PowerMatch amplifiers.
System Status Settings	Displays the default settings for how monitor panels appear within the application. Select AutoTile to toggle the auto tiling function on and off. Select Collapsed View to toggle the initial display state of all PowerMatch amplifier monitor panels between collapsed and expanded.
Wire Style	Selects Line, Orthogonal, or Bezier style of wiring. There are also several sub-types of Orthogonal wiring available.
Wire Colors	Selects the default wire color used for Audio, Network, or Logic wiring.
Show/Hide Wiring Crosshair	Toggles the wire drawing cursor between the standard Windows cursor and a crosshair (for more precise drawing).
Overview	Opens the Overview window. The Overview window contains a high level view of your signal processing design in Signal Processing View. Use your mouse cursor in the Overview window to draw a box around an area of your

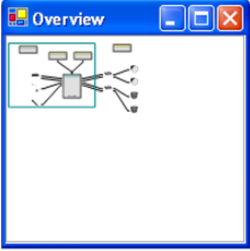
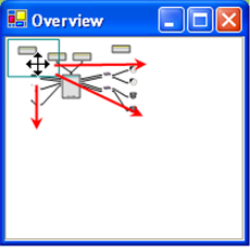
Function	Description
	<p>design that you would like to zoom in on.</p>  <p>Use the mouse in the Overview window to drag the zoom window around your design.</p>  <p>The Overview window can be kept open while making changes to your designs.</p>

Tools Menu

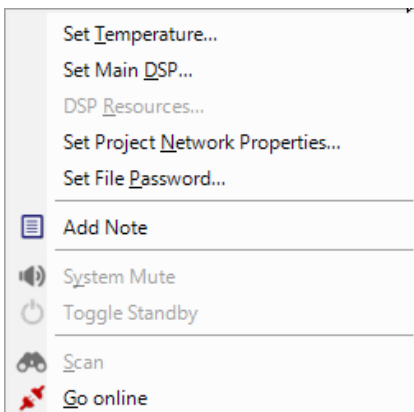

Function	Description
<p>Set Temperature</p>	<p>Opens the Temperature window to set the ambient temperature for which you would like to calculate delay times, in degrees Fahrenheit, or degrees Celsius. Alternatively, you can set the speed of sound at your design location in feet/sec or meters/sec. ControlSpace Designer software uses this value to calculate delay times when entered into a Delay signal processing block.</p> <p>NOTE: This setting does not change or modify any existing delay settings.</p>

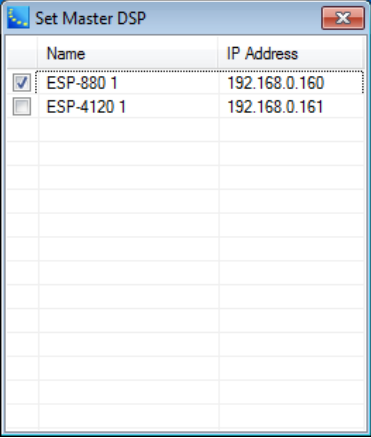
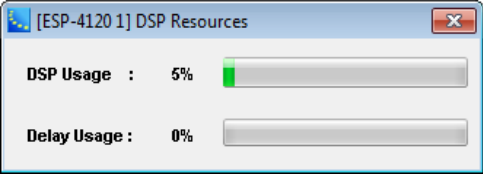
Function	Description						
	 <p>The Temperature dialog box has a title bar with a close button. It contains two radio buttons: 'Temperature' (selected) and 'Speed'. The 'Temperature' section has a numeric input field with '68.000' and a unit dropdown menu set to '°F'. The 'Speed' section has a numeric input field with '1127.625' and a unit dropdown menu set to 'f/s'.</p>						
Set Main DSP	<p>Opens the Set Main DSP window. In a design with multiple devices, use this window to specify which device is the Real Time Clock (RTC) for your system. Only one device can act as the RTC.</p>  <p>The Set Master DSP dialog box has a title bar with a close button. It contains a table with two columns: 'Name' and 'IP Address'. The table has two rows: 'ESP-880 1' with IP '192.168.0.160' (checked) and 'ESP-4120 1' with IP '192.168.0.161' (unchecked).</p> <table border="1" data-bbox="375 737 743 1136"> <thead> <tr> <th>Name</th> <th>IP Address</th> </tr> </thead> <tbody> <tr> <td><input checked="" type="checkbox"/> ESP-880 1</td> <td>192.168.0.160</td> </tr> <tr> <td><input type="checkbox"/> ESP-4120 1</td> <td>192.168.0.161</td> </tr> </tbody> </table>	Name	IP Address	<input checked="" type="checkbox"/> ESP-880 1	192.168.0.160	<input type="checkbox"/> ESP-4120 1	192.168.0.161
Name	IP Address						
<input checked="" type="checkbox"/> ESP-880 1	192.168.0.160						
<input type="checkbox"/> ESP-4120 1	192.168.0.161						
DSP Resources	<p>Opens the DSP Resources window to view the processing and delay memory usage for the selected ESP or EX-1280C.</p>  <p>The [ESP-4120 1] DSP Resources dialog box has a title bar with a close button. It contains two progress bars: 'DSP Usage : 5%' and 'Delay Usage : 0%'.</p>						
Set Project Network Properties	<p>Displays the Set Project Network Properties dialog. Allows you to define a new network and subnet for the current project (when you click OK, this becomes the current project network address). Any devices subsequently added to the Project View for the current project will then use the current project network address. An option is available to use the new network address for devices added to any new projects, not just the current project.</p>						

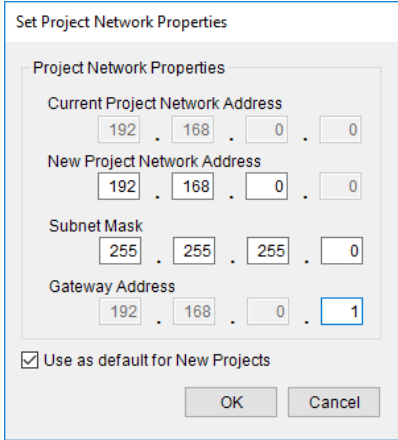
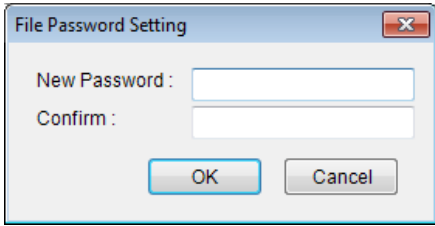
Function	Description
	
Set File Password	<p>The ControlSpace project file may be password protected to prevent modification. Once the project file is protected, all subsequent connections to the system via ControlSpace Designer will require the entry of the password before the connection is established.</p> 
Add Note	<p>Adds a text box to Project View or Signal Processing View for placing labels or notes on your design. For more information, see Adding Design Notes.</p>
System Mute	<p>Mutes all audio output when working online.</p>
Toggle Standby	<p>Places a connected device into or out of Standby. Only works with devices that support a Standby mode.</p>
Scan	<p>Detects hardware on your local network. When ControlSpace Designer software completes the scan, the Project View is automatically populated with the hardware devices that are properly connected in your local network.</p> <p>Do not use Scan while an existing project is open. This may result in a conflict that can cause a change in your system design configuration. Scan should be used only with a blank new project as a means to identify the hardware that exists on the local network.</p>
Go online/ Go offline	<p>Connects/disconnects a device. When connected to hardware on the ControlSpace network, click Go online to upload your system design, or download it from the hardware, and to adjust settings in real time.</p> <p>The background in Project View and in the Signal Processing View turn blue to indicate that you are now working online.</p> <p>If you are online, you can click Go offline to disconnect.</p>

System Menu

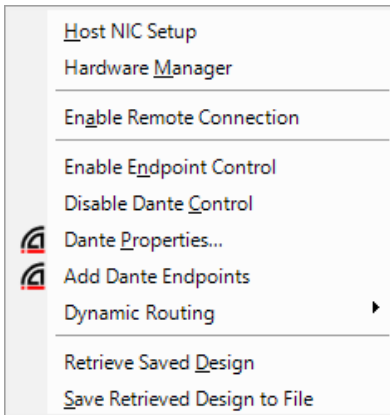

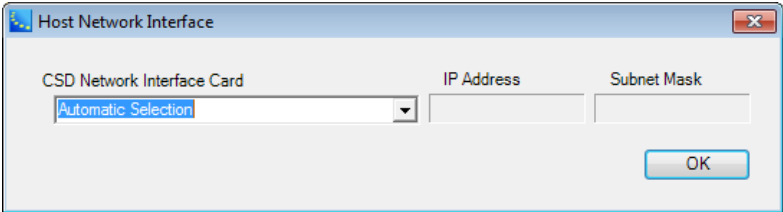
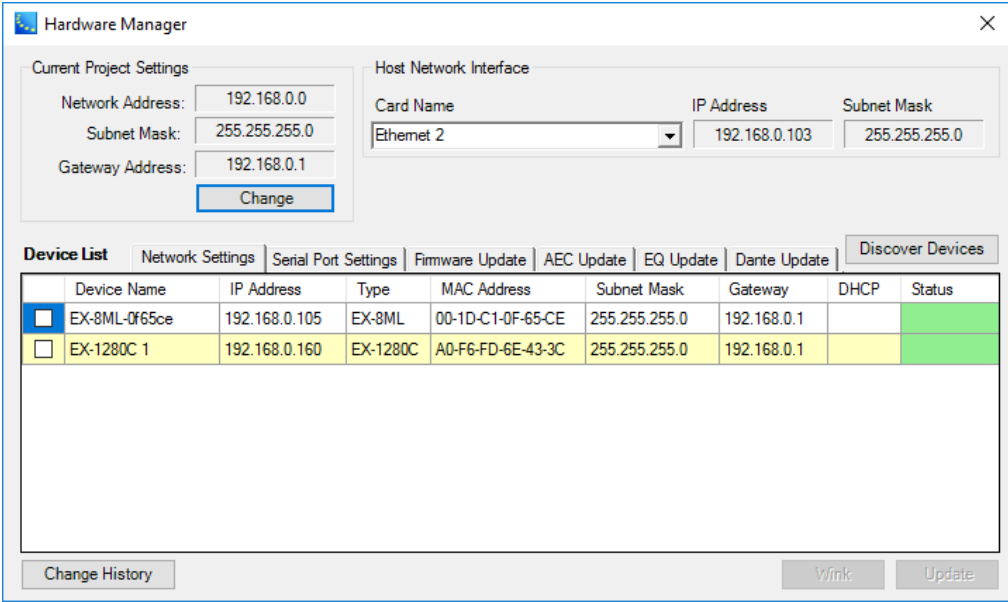
Function	Description
Host NIC Setup	<p>Opens the Host Network Interface window. For usage information, see Host Network Interface.</p> 
Hardware Manager	<p>Opens the Hardware Manager window. For usage information, see Launching the Hardware Manager.</p> 
Enable/Disable Remote Connection	<p>Allows you to make a remote network connection. Clicking Enable Remote Connection adds Remote Network Connection to the menu. Remote Network Connection opens a dialog for establishing connections to remote devices.</p>

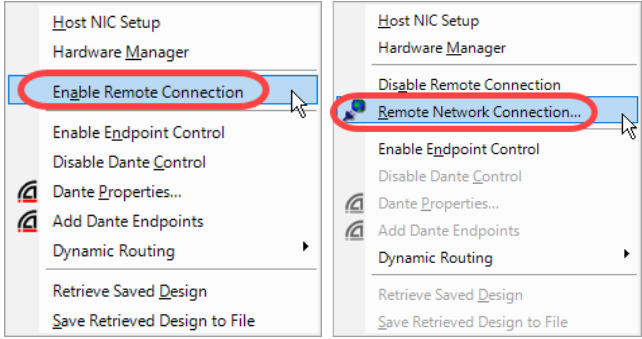
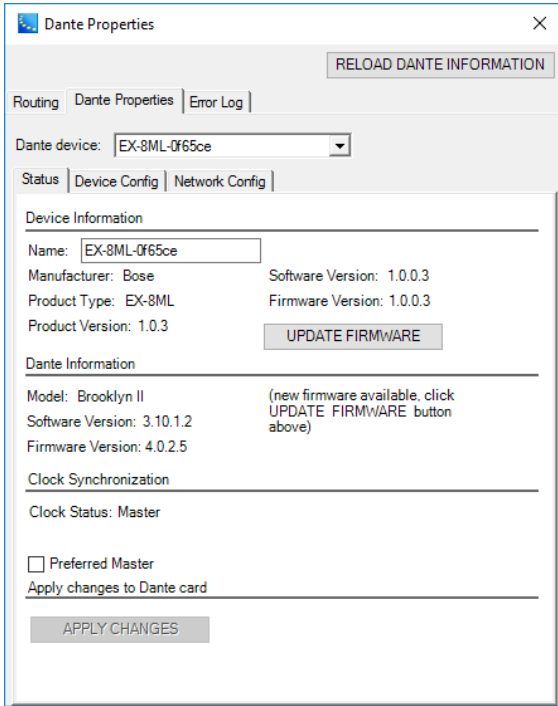
Function	Description
	
<p>Enable/Disable Endpoint Control</p>	<p>Normally Dante endpoints and Dante-equipped microphones are under the control of the firmware in ESP or EX-1280C sound processors.</p> <p>Select Enable Endpoint Control to test Dante device functionality or commands issued specifically from CSD software rather than firmware. You must be in Offline mode to use this command.</p> <p>Default: Disable Endpoint Control (Dante devices are under firmware control).</p>
<p>Disable/Enable Dante™ Control</p>	<p>Disable/Enable control of the Dante network using ControlSpace Designer software so that another software application, such as Dante Controller, can be used without interference.</p> <p>When disabled, Dante Properties are inaccessible. Default: Enabled.</p>
<p>Dante Properties</p>	<p>Opens the Dante Properties Window.</p> 
<p>Add Dante End-points</p>	<p>Normally, Project View in CSD automatically displays the device blocks of</p>

Function	Description
	<p>any Dante endpoints and Dante-equipped microphones that are found on the network. You may at some point delete one or more of these device blocks from Project View.</p> <p>Select Add Dante Endpoints to find and redisplay any Dante devices that were removed or deleted.</p>
Dynamic Routing	<p>Enable/Disable Dynamic Routing allows for dynamic routing changes between ControlSpace ESPs, the EX-1280C, and networked PowerMatch configurable power amplifiers using parameter sets. Dante Control must be enabled to use this option. Dynamic routing is disabled by default. For additional information on when and how to use this function, see "Enabling Dynamic Routing" on page 52.</p> <p>Update All Power On Subscriptions allows you to set up the desired routing and capture the those settings as the Power-On state for routing. For additional information on when and how to use this function, see "Setting the Dante Routing Used for Power-On" on page 53.</p>
Retrieve Saved Design	<p>Retrieves the project file without establishing a network connection to the system. Note that you must have an active network connection to enable this function.</p> <p>For additional information on when and how to use this function, see Retrieving System Configurations.</p>
Save Retrieved Design to File	<p>Retrieves the project file without establishing a network connection to the system, and immediately saves it as a file. Note that you must have an active network connection to enable this function.</p> <p>For additional information on when and how to use this function, see Retrieving System Configurations.</p>

Window Menu

Device <u>L</u> ist	
Project <u>D</u> irectory	
<u>P</u> roperties	
<u>P</u> arameter Sets	
ParameterSet <u>L</u> ists	
<u>G</u> roups	
<u>R</u> CGroups	
<u>T</u> imers	
<hr/>	
<u>H</u> ide All	
Load to default positions	

Function	Description
Device List	Toggles the Device List between show and hide when in Project View. When working in Signal Processing View, toggles the SP Tool Kit between show and hide.
Project Directory	Toggles the Project Directory window between show and hide.
Properties	Toggles the Properties window between show and hide.
Parameter Sets	Toggles the Parameter Sets window between show and hide.
Parameter Set Lists	Toggles the Parameter Set Lists window between show and hide.
Groups	Toggles the Groups window between show and hide.
RCGroups	Toggles the RCGroups window between show and hide.
Timers	Toggles the Timers window between show and hide.
Hide All	Closes all windows except Project View and the Signal Processing View.
Load to default positions	Returns all open windows to their default location in ControlSpace Designer software.

Help Menu

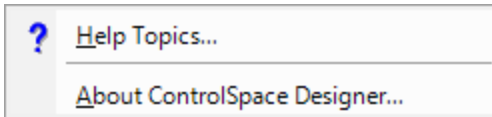

Function	Description
Help Topics	Opens the ControlSpace® Designer™ help.
About ControlSpace Designer	Opens the About ControlSpace Designer software release information window.

Configuring Devices

Building a Project File

The first step in creating a ControlSpace® system design is to specify the hardware components you intend to use. In ControlSpace® Designer™ software this is accomplished by launching the program and adding new devices to a project.

Project Files

Each system design is stored in a file with a .CSP file extension. This file contains configuration information, settings, and control functions for all ControlSpace sound processors and PowerMatch amplifiers. In addition to creating new files, there are several methods to retrieve files and settings stored within the hardware devices. For more information, see Retrieving System Configurations.

When you launch ControlSpace Designer software, a new project is automatically created in temporary working memory and named "Untitled". You must save this information to disk to store the file for use in the event of a power loss. The first time you save a project, you are prompted to provide a name for it.

Adding Devices

Devices are added to your system design by dragging the device icons in the Device List on the left into the Project View on the right. The Project View is a workspace that allows you to graphically lay out the system design. In the following example, the ESP-880 and any CC-64s and CC-16s are part of the design. Although you can add other components, such as microphones and loudspeakers, they are for reference only and do not perform any function in ControlSpace® Designer™ software.

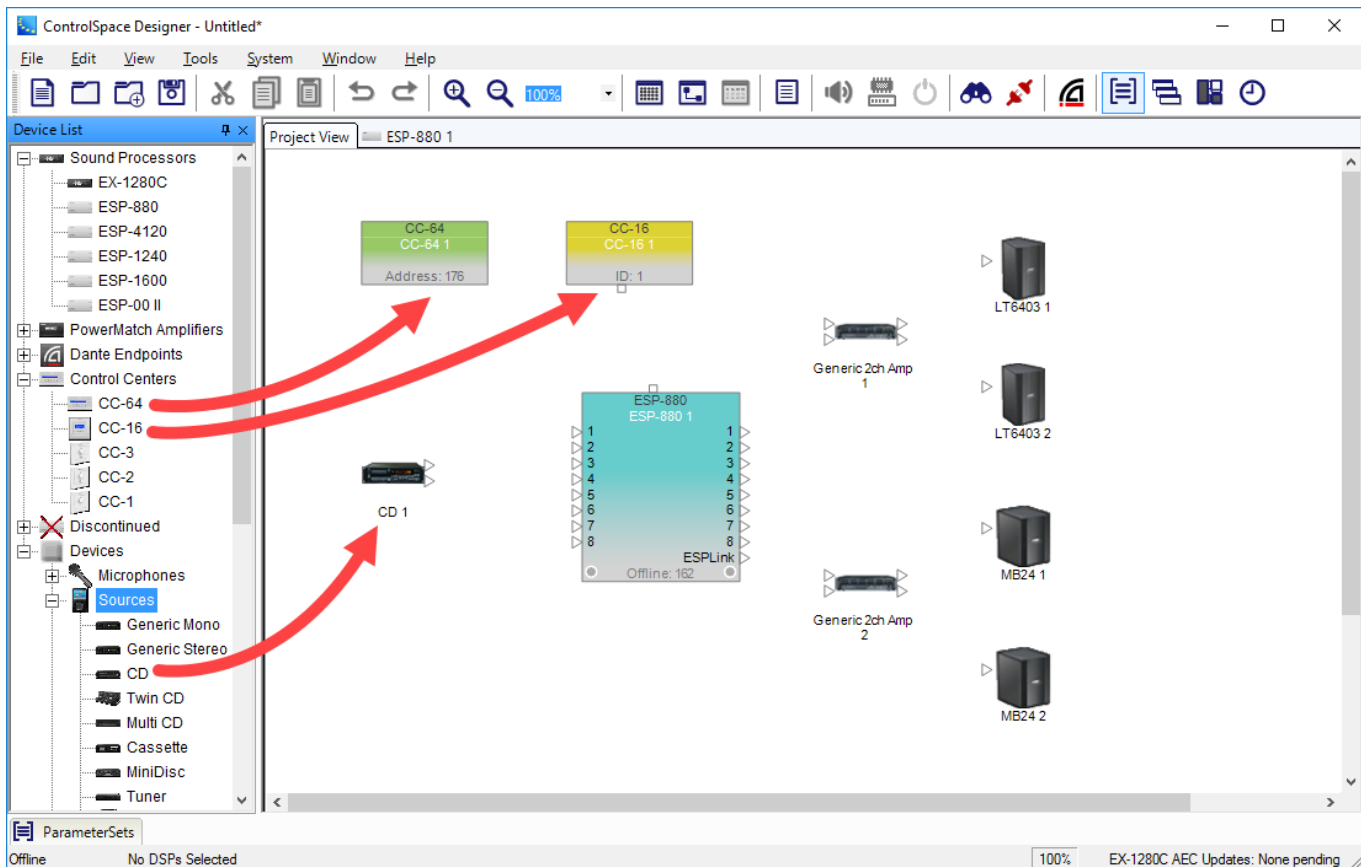

Dragging and dropping devices into Project View

Other Device Block and Wiring Operations

For more information on device wiring operations, see ["Wiring Operations" on page 107](#).

For more information on device block-handling functions, see ["Block-Handling Functions" on page 103](#).

Adding Design Notes

To add a note to your design, click the Add Note icon  in the menu bar. This places a text frame in the design workspace.

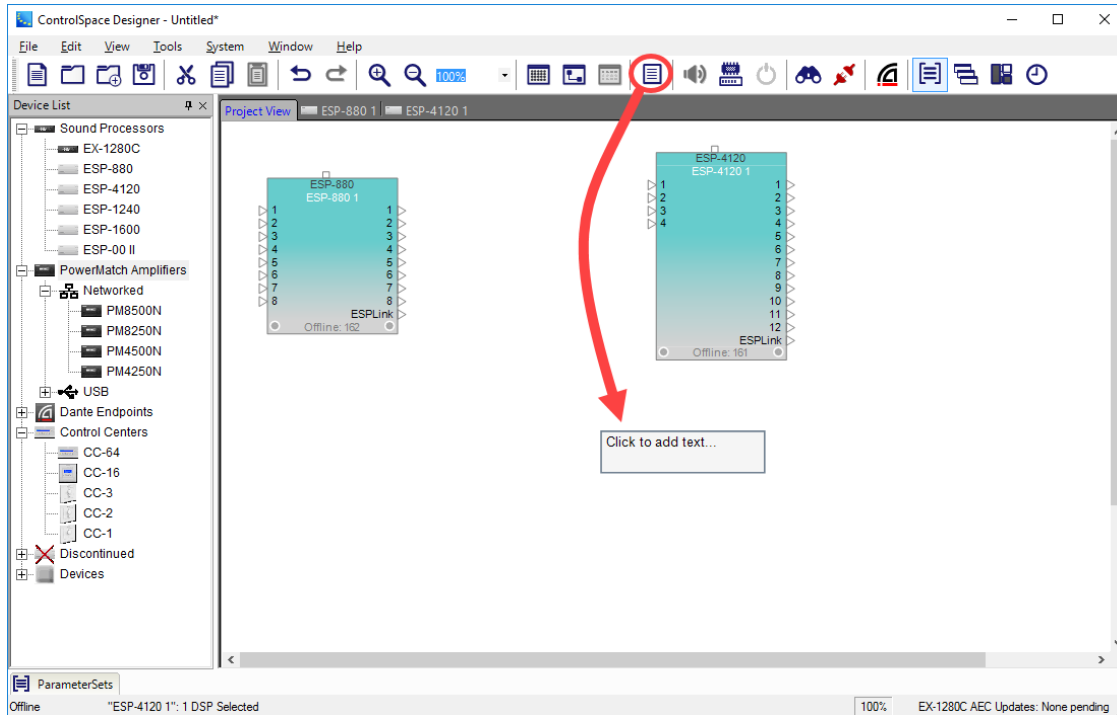

Click the text frame to select it. Notice the handles on the border of the frame. You can click and drag any of these to re-size the text frame.

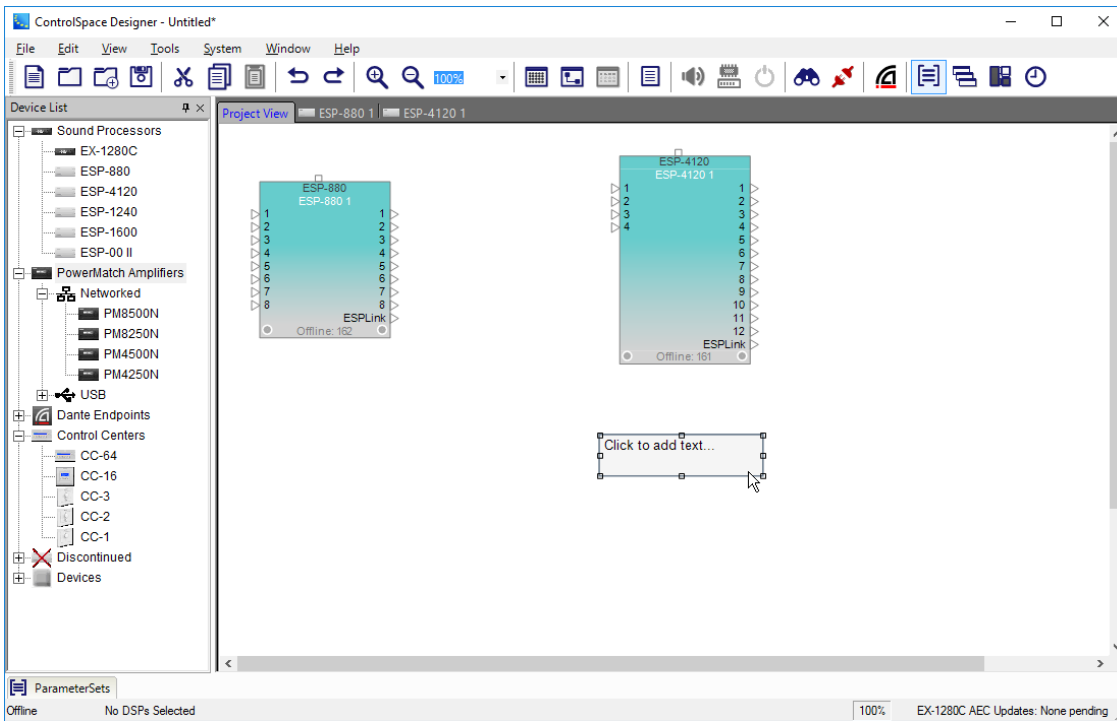

Click and drag the text frame to where you want it.

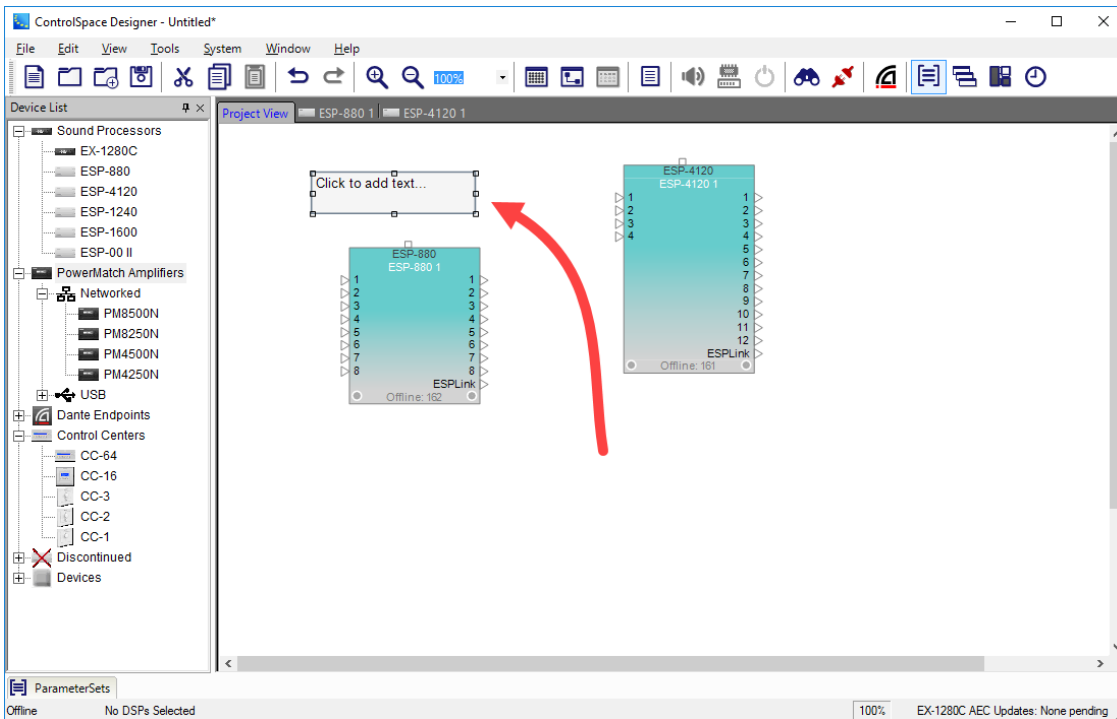

Click inside the text frame. Notice that the text line is highlighted in blue.

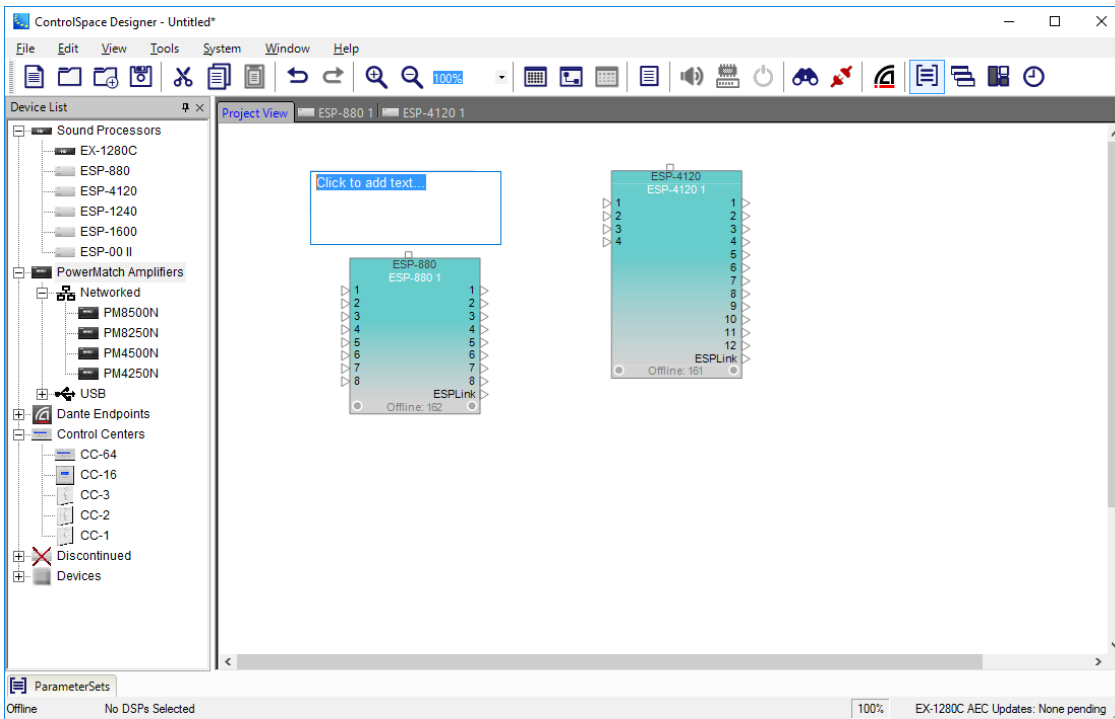

Enter the text you want in the frame. When done, click outside the text frame. Select the text frame again to adjust its size and location.

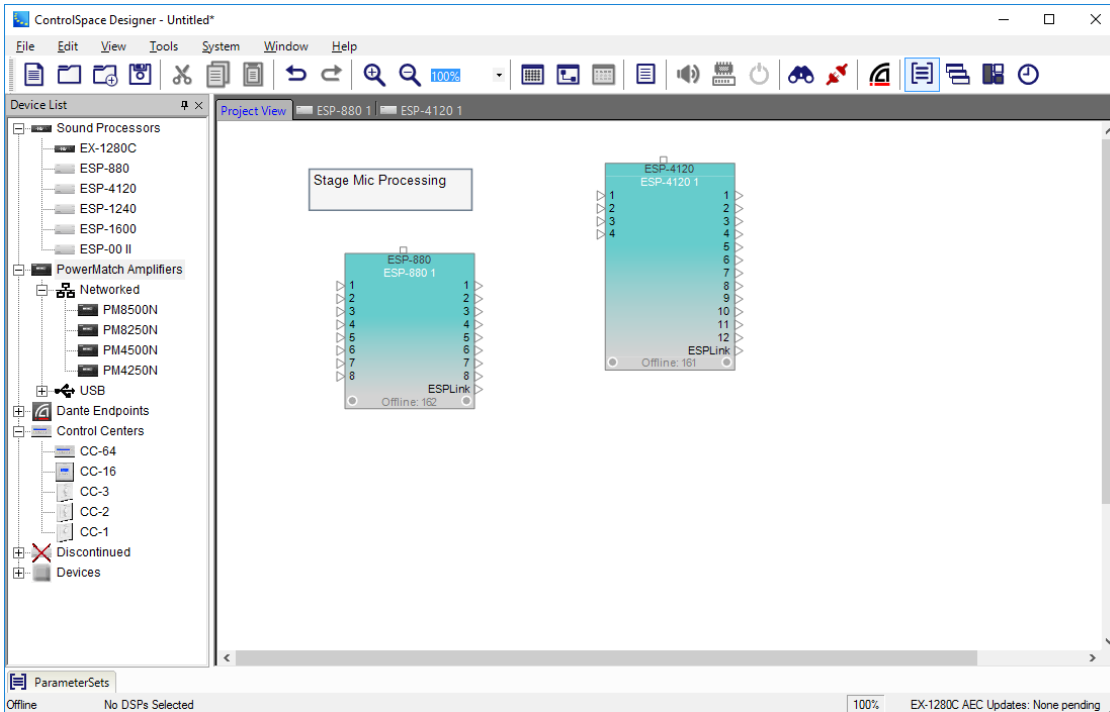

Right-clicking a text frame opens a menu that provides additional editing functions.

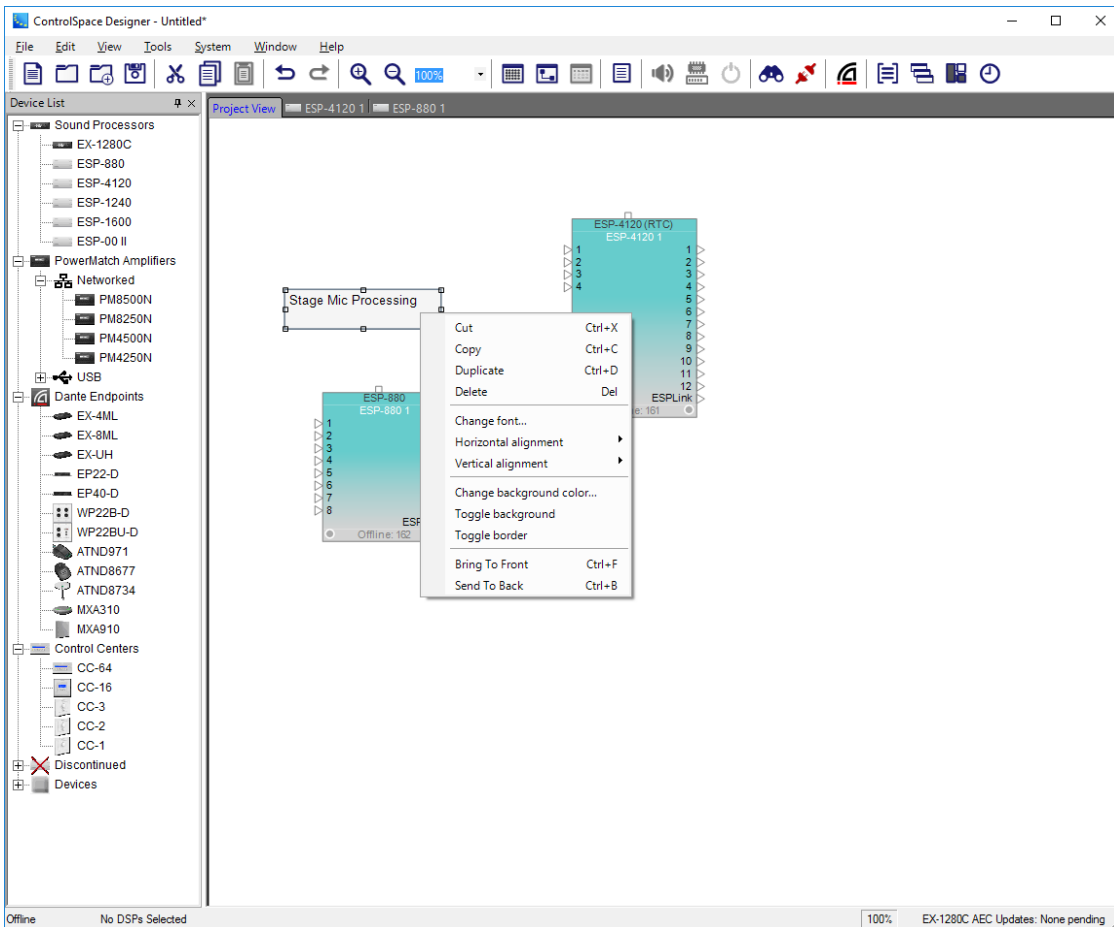

Cut, **Copy**, **Delete**, and **Duplicate** are the standard Windows editing functions.

Change font... allows you to select font style and size.

Horizontal alignment offers you the choice of Left, Center, or Right.

Vertical alignment offers you the choice of Top, Center, or Bottom.

Change background color... lets you choose a background color from the color palette.

Toggle background switches between the selected color and no color.

Toggle border switches between a border and no border.

Bring to front places the text frame in front of design icons.

Send to back moves the text frame behind design icons.

Adding Project Information

ControlSpace® Designer™ provides a feature for documenting contact information and comments related to the project design. This is an especially helpful feature for service technicians accessing the system in the future. To access this feature, select **Project Information** from the **File** menu.

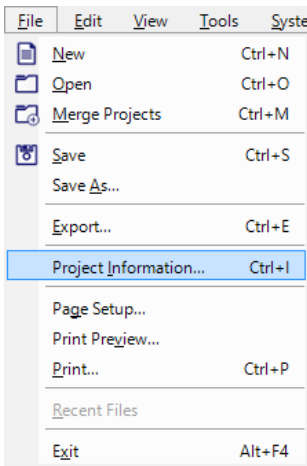

The Project Information Window supports entry of contact information for multiple project participants as well as six multi-line comment fields. There is no limit to the amount of text you may enter in the comment fields, and all information stays with the design when the project file is saved to disk or uploaded to the system.

BusinessManager	Email	Telephone
<input type="text"/>	<input type="text"/>	<input type="text"/>
Engineer	Email	Telephone
<input type="text"/>	<input type="text"/>	<input type="text"/>
Customer	Email	Telephone
<input type="text"/>	<input type="text"/>	<input type="text"/>
Address		Fax
<input type="text"/>		Cell Phone
<input type="text"/>		<input type="text"/>

Comment1	Comment2
<input type="text"/>	<input type="text"/>
Comment3	Comment4
<input type="text"/>	<input type="text"/>
Comment5	Comment6
<input type="text"/>	<input type="text"/>

Project Information window

Accessing Signal Processing View

Each device that has signal processing functions has a Signal Processing View indicated by a Device tab to the right of the Project View tab. Signal Processing View for devices can be opened by clicking the tab or double clicking on the device block in the Project View.

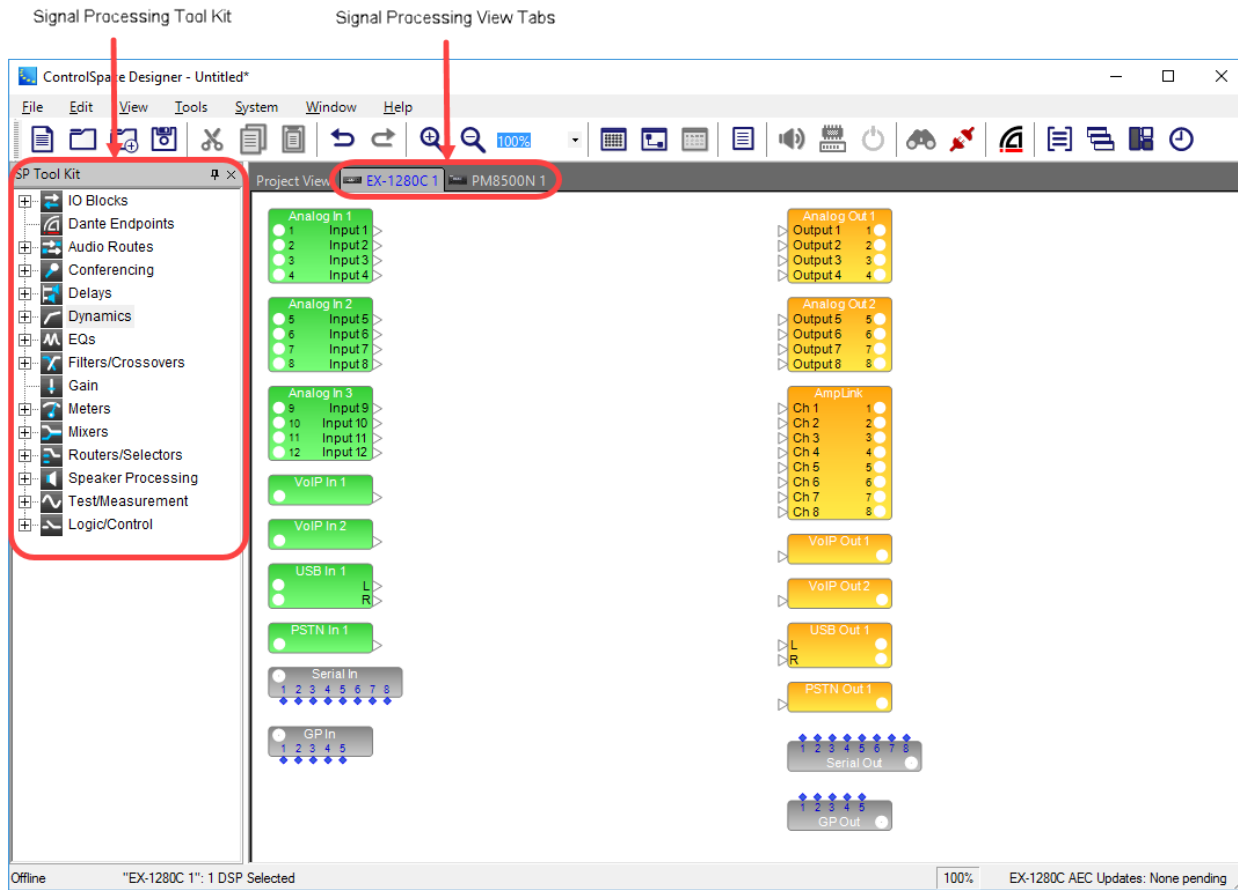

Signal Processing View and SP Tool Kit

The first time you access the Signal Processing View, there are no wired audio connections or project-specific signal processing blocks. Audio input and output blocks are included in Signal Processing View for default hardware and optional expansion cards, with the exception of the Dante I/O channels in the EX-1280C sound processor. For information on adding Dante I/O channels to the EX-1280C sound processor, see [EX-1280C Dante™ Input/Outputs](#).

NOTE: The signal processing blocks and flow in PowerMatch amplifiers are predefined.

The SP Tool Kit lists the various signal processing blocks which may be used within the selected device.

Below is a table showing the available signal processing (SP) tools for each type of processor:

Signal Processing Tools	ESP-00	ESPs (Fixed I/O ¹)	EX-1280C
I/O Blocks			
Add/Remove I/O	Hardware	Fixed	Software
Add/Remove Dante I/O	No	Yes	Yes
Dante Endpoints	No	Yes²	Yes
Audio Routes	No	Yes	Yes

Signal Processing Tools	ESP-00	ESPs (Fixed I/O¹)	EX-1280C
Conferencing			
Conference Room Router (CRR)	No	No	Yes
Acoustic Echo Cancellation (AEC)	No	No	Yes
Delays			
1 out	Yes	Yes	Yes
2 out	Yes	Yes	Yes
4 out	Yes	Yes	Yes
8 out	Yes	Yes	Yes
Dynamics			
Automatic Gain Control (AGC) (m/s)	Yes	Yes	Yes
Automatic Gain Control (AGC), enhanced	No	No	Yes
Compressor/Limiter (m/s)	Yes	Yes	Yes
Ducker (m/s)	Yes	Yes	Yes
Gate (m/s)	Yes	Yes	Yes
Peak RMS Limiter (m/s)	Yes	Yes	Yes
EQs			
Array EQ	Yes	Yes	Yes
Predictive Feedback Suppression (PFS)	No	Yes	Yes
Graphic EQ - 1/3 Oct.	Yes	Yes	Yes
Parametric EQ (m/s)	Yes	Yes	Yes
Tone EQ	Yes	Yes	Yes
Filters/Crossovers			
2 way	Yes	Yes	Yes
3 way	Yes	Yes	Yes
4 way	Yes	Yes	Yes
Gain	Yes	Yes	Yes

Signal Processing Tools	ESP-00	ESPs (Fixed I/O¹)	EX-1280C
Meters			
4 channel	Yes	Yes	Yes
8 channel	Yes	Yes	Yes
16 channel	Yes	Yes	Yes
Mixers			
Automatic Microphone Mixer (AMM), Gain Sharing	No	Yes	Yes⁴
Automatic Microphone Mixer (AMM), Gated	Yes³	Yes³	Yes⁴
Matrix Mixer	Yes	Yes	Yes
Standard Mixer	Yes	Yes	Yes
Standard Room Combiner (StRC)	No	Yes	Yes
Routers/Selectors			
Router	Yes	Yes	Yes
Source Selector (m/s)	Yes	Yes	Yes
Speaker Processing			
Single Speaker	Yes	Yes	Yes
MidHigh + Bass	Yes	Yes	Yes
Bass Array - 2 Box	Yes	Yes	Yes
Bass Array - 4 Box	Yes	Yes	Yes
Speaker PEQ	Yes	Yes	Yes
Test/Measurement			
Sine Generator	Yes	Yes	Yes
Noise Generator	Yes	Yes	Yes
Sweep Generator	Yes	Yes	Yes
Logic/Control			
Logic Routes	No	No	Yes
Logic Block	No	No	Yes
Logic Input	No	No	Yes

Signal Processing Tools	ESP-00	ESPs (Fixed I/O ¹)	EX-1280C
Logic Output	No	No	Yes
Parameter Set Recall	No	No	Yes
Control Library⁵			
Parameter Sets	Yes	Yes	Yes
Parameter Set Lists	No	Yes	Yes
Groups	Yes	Yes	Yes
RCGroups	No	Yes	Yes
Timers	Yes	Yes	Yes

(m/s) = mono/stereo

¹ See [Configuring Devices > Engineering Sound Processors \(ESPs\) > Engineering Sound Processor \(ESP\) Devices](#) for a complete list of fixed-I/O processors.

² MSA12X only.

³ Default functionality.

⁴ AMM linking / advanced functionality.

⁵ Not listed in signal processing tools. See [Controlling System Devices > Control Library > Programming Work Space](#).

Block-Handling Functions

ControlSpace® Designer™ provides a variety of block-handling functions for devices in Project View or SP blocks in SP View.

NOTE: See the [Edit Menu](#) for additional block-handling functions.

Renaming Single Blocks or Devices

To rename any SP block or device, right-click on the block or device and select **Rename**, or press **F2**. You can also use the **Label** property in the **Properties** window to rename a device or SP block.

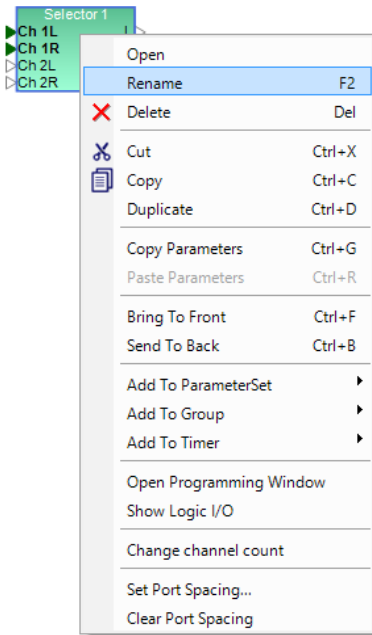

Renaming a signal processing block

Renaming Multiple Blocks or Devices Using Wildcards

To rename multiple similar devices or SP blocks simultaneously and assign a unique sequential number to each name:

1. Select each device or SP block you want to rename.
2. Right click on one of the objects and select **Rename Selection** (or press **F2**).
3. Enter a new name for the objects, including a * wildcard character as a placeholder for the assigned number. For example, if you enter "Program In-*", each selected object will be named Program In-1, Program In-2, and so on. The assigned number can be anywhere in the device or block name, including the middle of the name, e.g. "Program * In" would rename blocks as Program 1 In, Program 2 In, and so on.

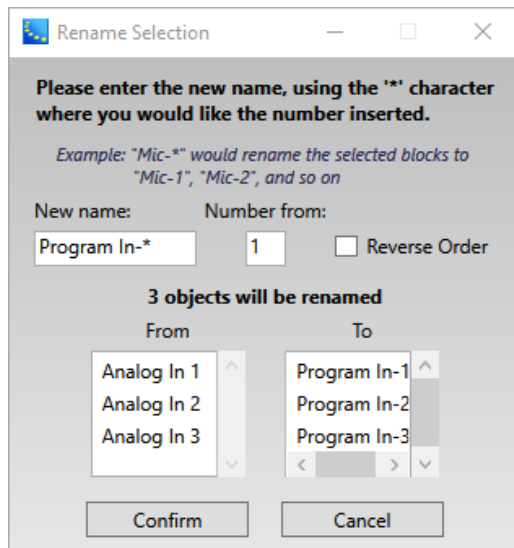

Renaming multiple blocks using wildcards

- You can optionally designate the starting number and whether sequential numbers will be assigned in reverse order (ascending order is the default sequence). You can preview the new names in the To listing.
- Click **Confirm** to rename the selected objects.

Setting Port Spacing

You can adjust the vertical spacing between ports on an SP block or device. The size of the block or device will increase to fit the wider port spacing. For example, you can set the port spacing on two blocks such that the wire connections between the two blocks are straight, more widely spaced, and evenly distributed.

- Right click on the device or block and select **Set Port Spacing**.
- The default spacing for ports is 0. For each port that you want to adjust, select the appropriate side (Right Ports or Left Ports) and enter the amount of spacing you want *before* each port. For example, selecting 1 for a port will increase the spacing before the port by one unit.

In this example, the current port spacing is shown below:

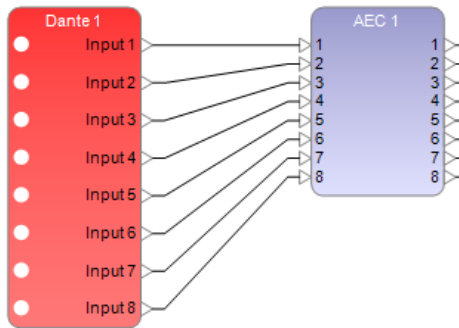

The user adjusted each port spacing to 1 (except for the first port) on the left side of the AEC block to match the port spacing on the right side of the Dante block.

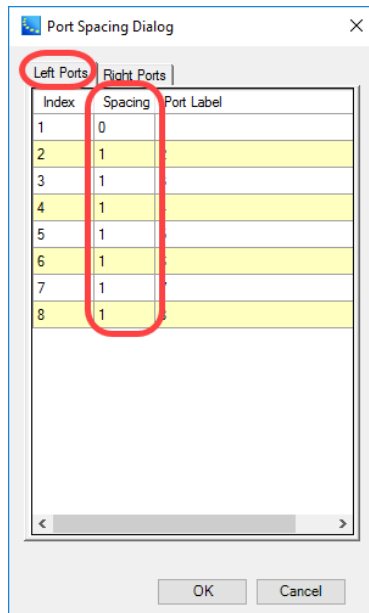

- Click **OK**. The size of the AEC block and ports are now adjusted to meet the new spacing require-

ments.

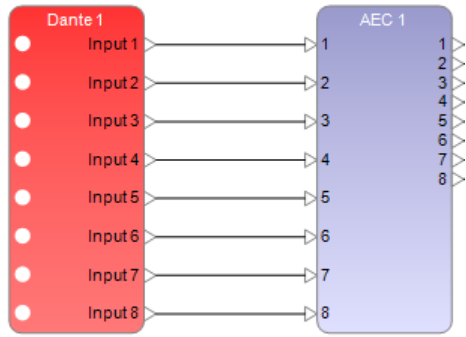

NOTE: To reset the port spacing to the default, right-click on the block and select **Clear Port Spacing**.

Copy Parameters

You can copy the parameters from one block to one or more selected blocks of the same type. Note that this only copies or pastes the block parameters (settings and their values). It does not copy or paste the block itself:

For Selectors, Routers and Standard and Matrix Mixers only:

- This includes input and output channel labels.
- Blocks with smaller channel counts can be pasted into blocks with larger channel counts. Values are pasted into the lowest channel numbers.

Right-click on the SP block and select **Copy Parameters**.

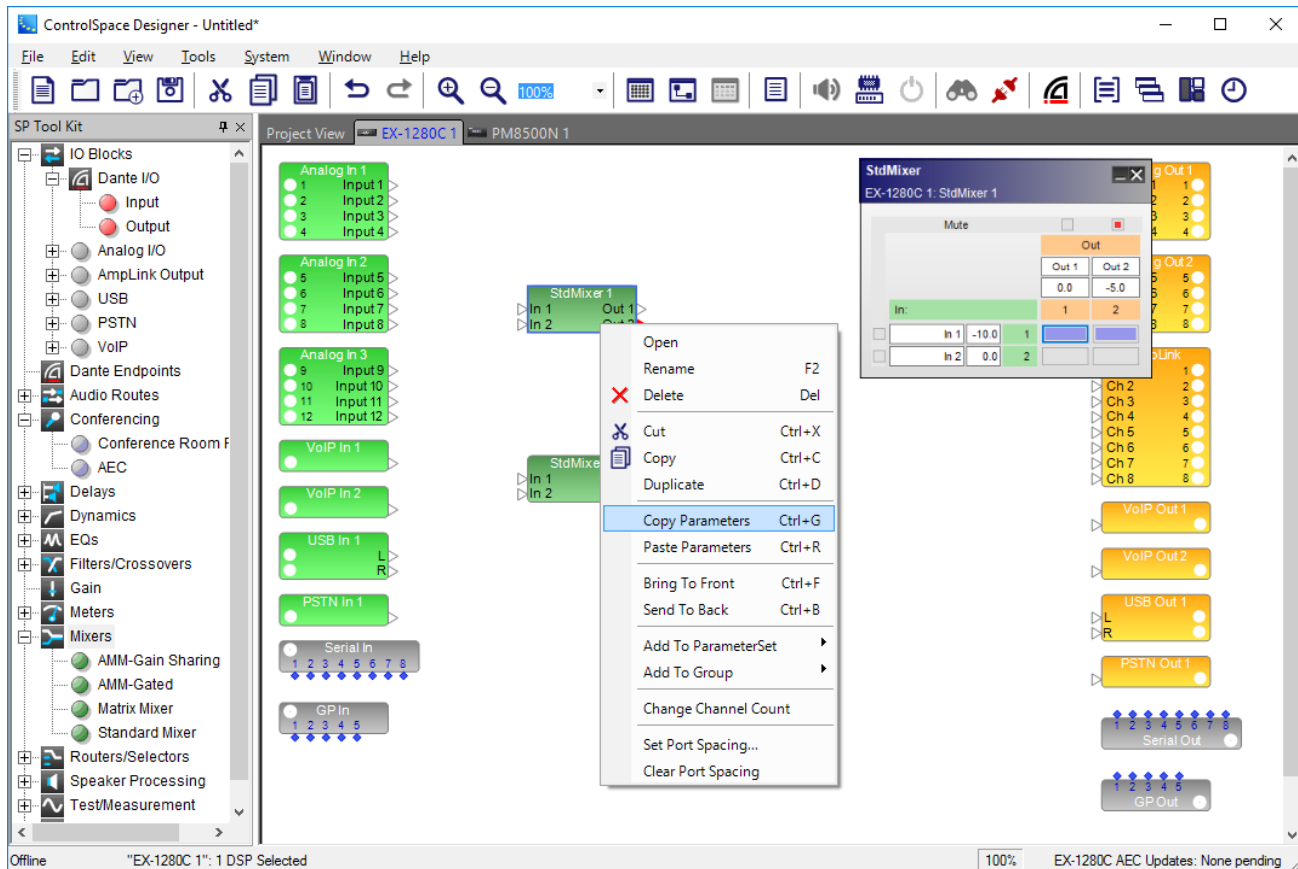

Right-click on the other SP block of the same kind and select **Paste Parameters**.

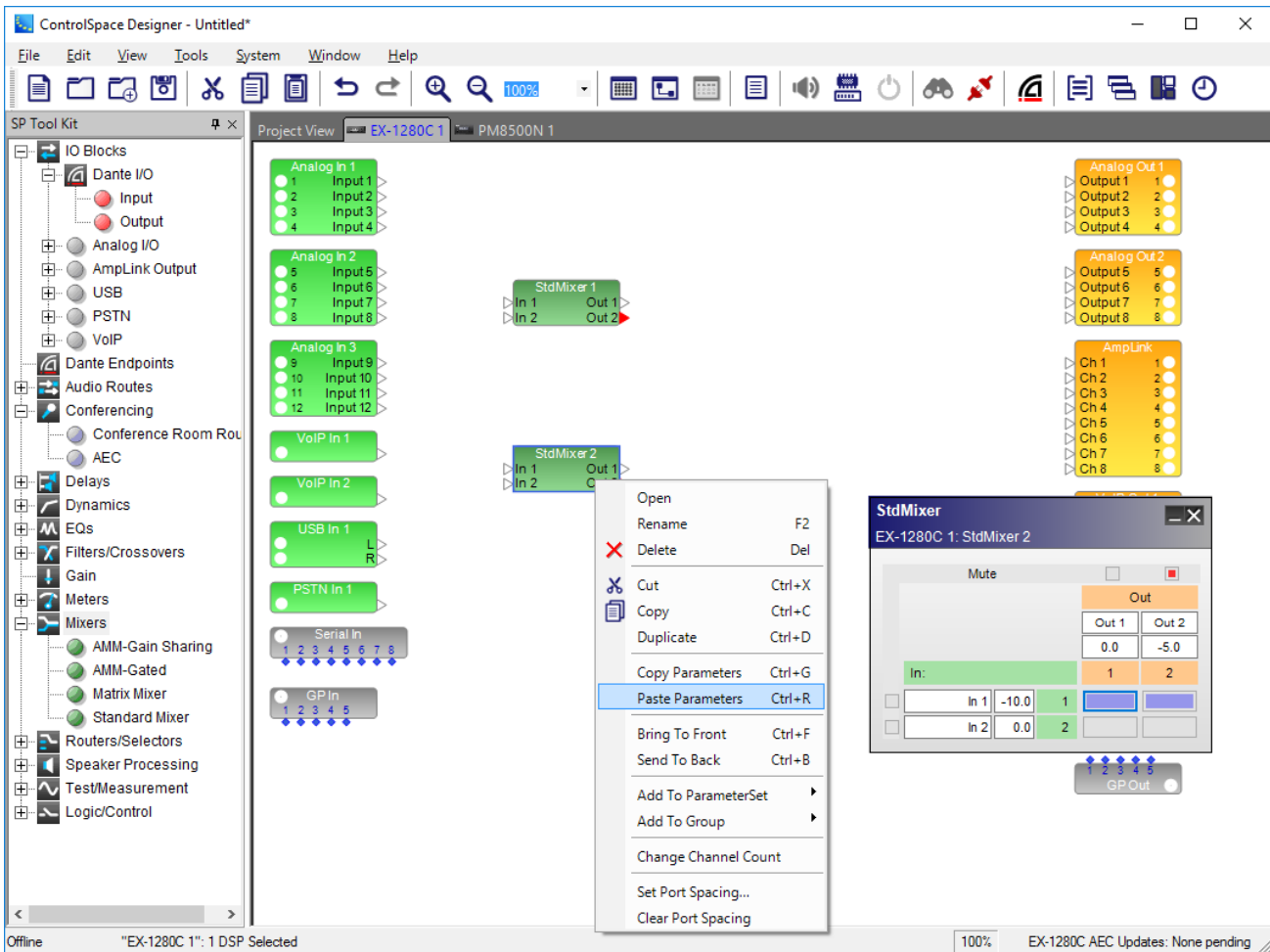

Wiring Operations

ControlSpace® Designer™ provides a variety of wiring and connection tools for devices in Project View or SP blocks in SP View.

NOTE: See the **"View Menu"** on page 85 for additional wiring functions.

Single Wire Connections

You can click a port on one SP block or device and then click a port on another SP block or device to connect them. Or you can click a port and drag to connect it to the other port on another SP block or device.

Note that the examples are for devices in Project View, but also apply to blocks in Signal Processing View.

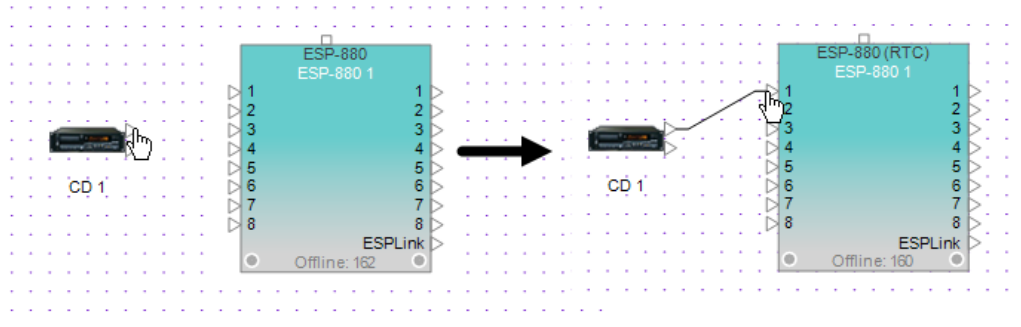

Clicking and dragging a wire from output to input

To delete a wire, click anywhere on the wire to select it and display control points. Then, press the **Delete** key.

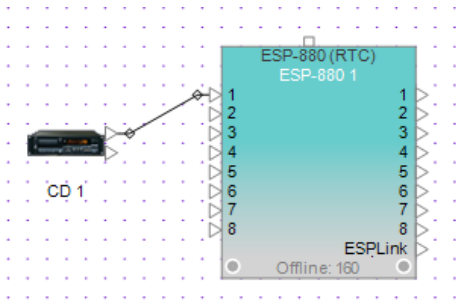
*Deleting a wire*

To move a wire, click anywhere on the wire to select it and display control points. Then, click and drag a control point to the new location.

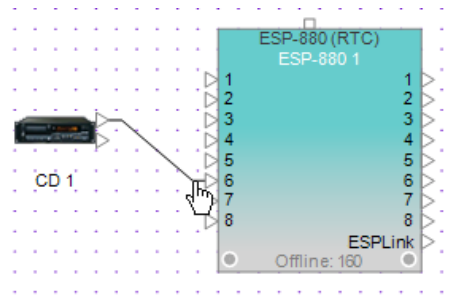
*Dragging the control point to move a wire***Multiple Wire Connections**

To wire multiple ports on one block or device simultaneously to the corresponding ports on another SP block or device:

1. Click and drag to select all of the ports on the device or SP block that you want to connect to the other device or SP block. The ports will be highlighted in gold.

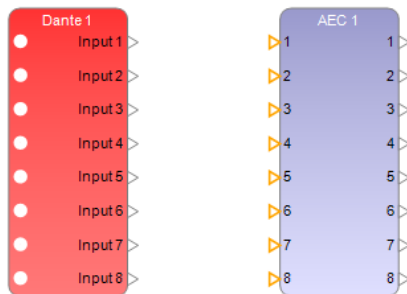

2. Click one of the highlighted ports and drag a wire to the corresponding port on the other device or SP block.

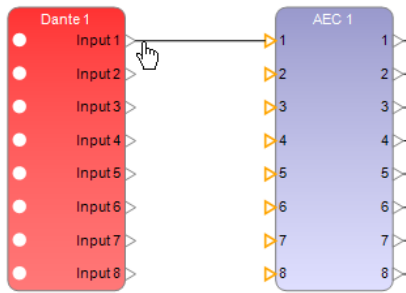

- When you release the mouse button, each of the corresponding ports will be interconnected.

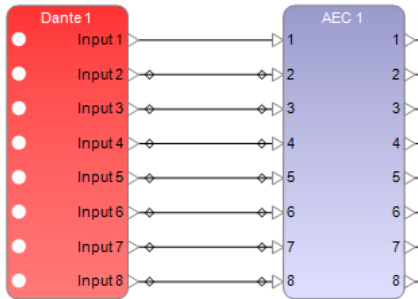

Alternatively, you can select the ports on one block or device that you want to connect to the other block or device, press and hold the **F3** key, click any port on the other device or SP block, and release **F3** to perform the same operation.

Fan-Out Wire Connections

To wire a single port on one SP block or device so that it fans out to multiple ports on another SP block or device:

- Click and drag to select all of the ports on the device or SP block that you want to connect to the single port on the other device or SP block. The ports will be highlighted in gold.

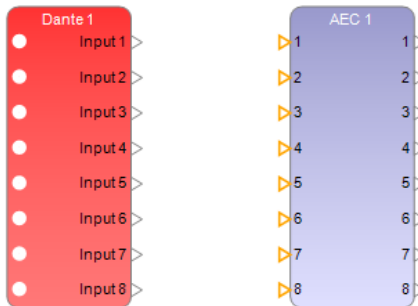

- Press and hold the **F4** key.
- Click the single port on the other device or SP block.

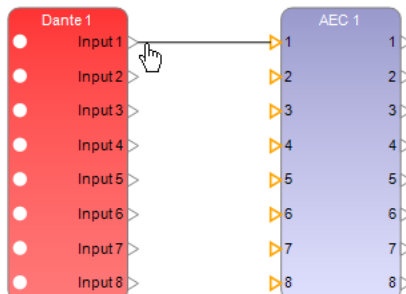

- When you release **F4**, the single port connection will fan out to the multiple ports on the other device

or SP block.

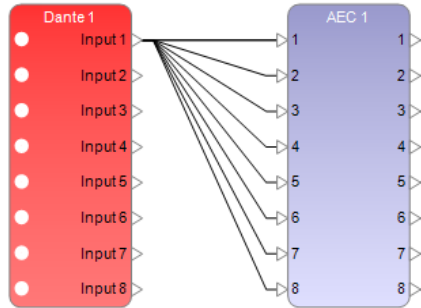

Routing Control of Orthogonal Wires

Control points provide additional bend "handles" for orthogonal style wires, allowing a finer degree of control over wire routing when needed, e.g. when a design has so many objects that a designer needs more right-angle bends to route wires around them.

The default orthogonal wire style has two control points. You can add two more control points to an orthogonal wire, for a maximum of four. The designer can then drag those control points to maneuver wires around an object.

In this example, assume that the designer does not want to move the Analog Out 1 block but rather re-route the orthogonal wire connecting the gain blocks around the Analog Out 1 block so that the wire is not covered by the block. This cannot be done with the default number of control points so adding two control points is the solution.

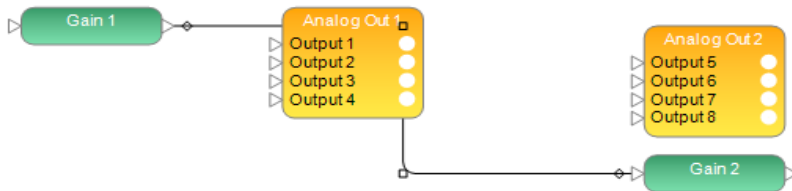

To add two more control points to the orthogonal style wire:

1. Right-click the wire and select **Add control points**. Two control points are added.
2. You can then drag these control points to bend the wire appropriately around objects.

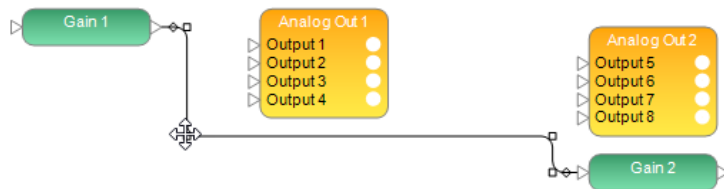

To reset the wire to the default number of control points, right-click the wire and select **Reset control points**.

Wire Connection Labels

To add labels to the starting, middle, or ending positions on a selected wire and specify label colors:

1. Right-click the wire and select **Wire properties**.
2. Specify the Start, Middle, and/or End Label text for the wire. The label text will appear in a box just above the wire.
3. Click the Text Color field to display a color palette. Select a color for the label text from the palette and click **OK**.

- Click the Background Color field to display a color palette. Select a background fill color for the inside of the box that contains the label text and click **OK**.

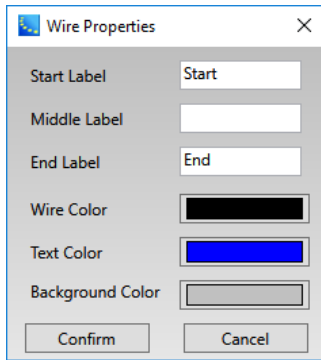

- To add or apply the changes, click **Confirm**.



Wire Connection Color

To change the color of a selected wire:

- Right-click the wire and select **Wire properties**.
- Click the Wire Color field to display a color palette. Select a color for the wire from the palette and click **OK**.

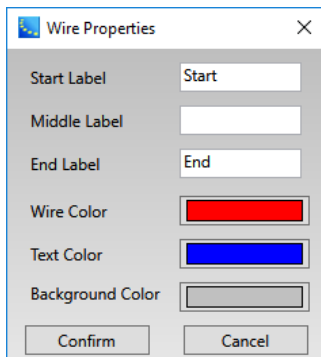

- To add or apply the changes, click **Confirm**. The new color overrides any default color set for this wire type.



To change the default color of wires by type, see the **Wire Colors** function in the **View** menu.

Audio Routes

Use audio routes in ControlSpace Designer to pass audio between two locations within a single ESP or EX-1280C device as if they were connected, but without the need to wire them together directly. It is similar to a named object or net in schematic diagrams, where objects with the same name are assumed to be connected.

This provides a convenient virtual wiring shortcut from one location in a design to another and is helpful when many intervening or blocking design elements make it difficult to route wires between the two points.

NOTE: The ESP-00 II does not support Audio Routes.

To create an audio route:

1. From the SP Tool Kit, drag a New Audio Route block into Signal Processing View. This creates a single-port input and output block, both labeled Audio Route x by default.



NOTE: You can also route one input audio route block to multiple output audio route blocks (use the right-click **Duplicate** function to create the desired number of output blocks).

2. If needed, change the block labels by selecting one of the blocks and changing the Label name in the Properties window (**Window > Properties**) or by pressing the F2 key and changing the label in the text box. The labels will automatically change on both blocks, since the labels must match to implement the audio route.



3. If needed, change the number of channels by right clicking on a block and selecting **Change Channel Count**. As with label changes, any change in the number of channels will propagate to both blocks.



4. Drag the input and output audio route blocks to the appropriate locations in your design.
5. Wire any audio inputs to the input audio route block and any audio outputs from the output audio route block, as needed.

Audio signals will now flow from the input audio route block to the output audio output block as if they were interconnected.



Engineered Sound Processors (ESPs)

Engineered Sound Processor (ESP) Devices

The **Device List** in the window below shows the available engineered sound processors that may be added to your system design.

- Expandable I/O ESP - ESP-00 II
- Fixed I/O ESPs - ESP-880, ESP-4120, ESP-1240, and ESP-1600

Bose control devices and generic devices are included in the Device List below the Signal Processors. The generic devices are used to illustrate system components and connectivity. These ESPs are added to the Project View using the same drag-and-drop method as other devices within the ControlSpace® Designer™ software.

NOTE: Wiring within Project View is for reference purposes only and does not affect the audio signal path between devices.

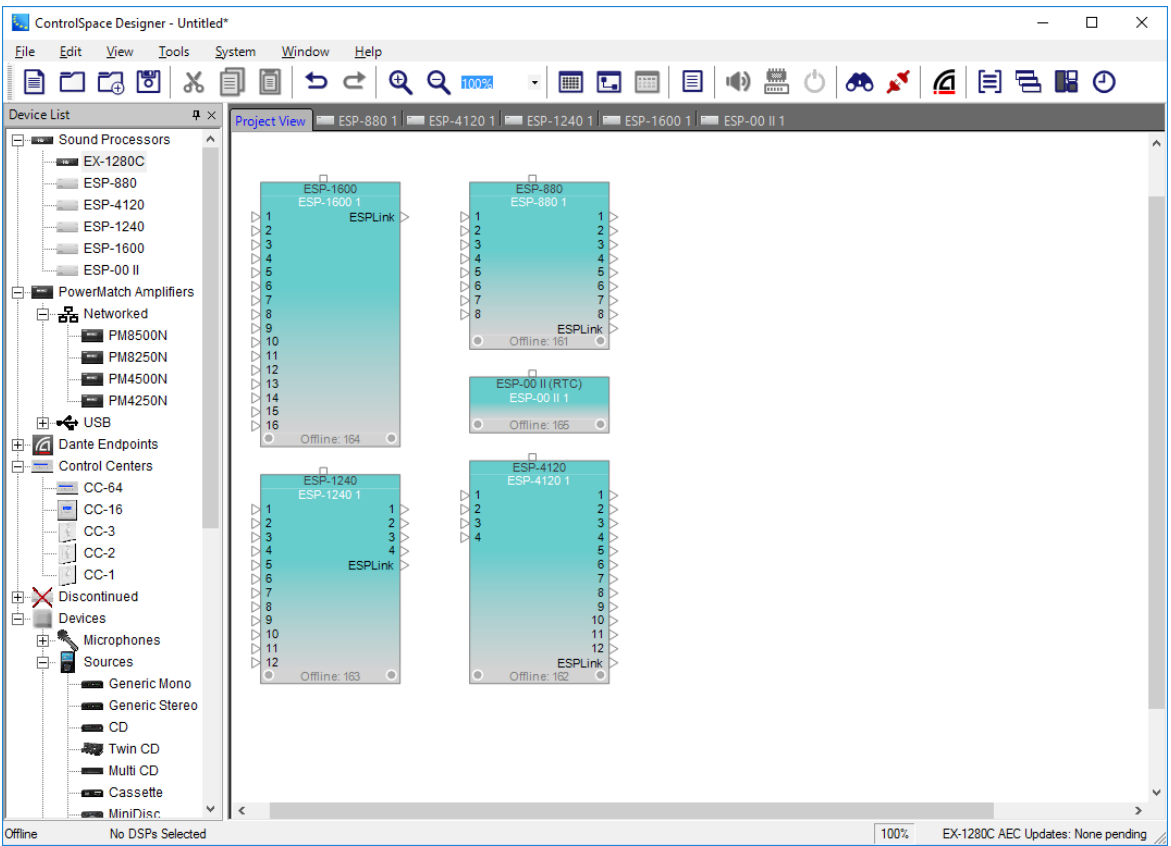

Available engineered sound processors and their associated Project View icons

ESP-00 II Processor

ESP-00 II Device Properties

The ESP-00 II engineered sound processor block is initially an empty chassis with no audio inputs or outputs. Input and output cards must be added to the processor block using the Properties panel and must match the hardware configuration. To access the ESP-00 II properties panel, right-click on the ESP-00 II icon in the **Project View** and select **Properties**.

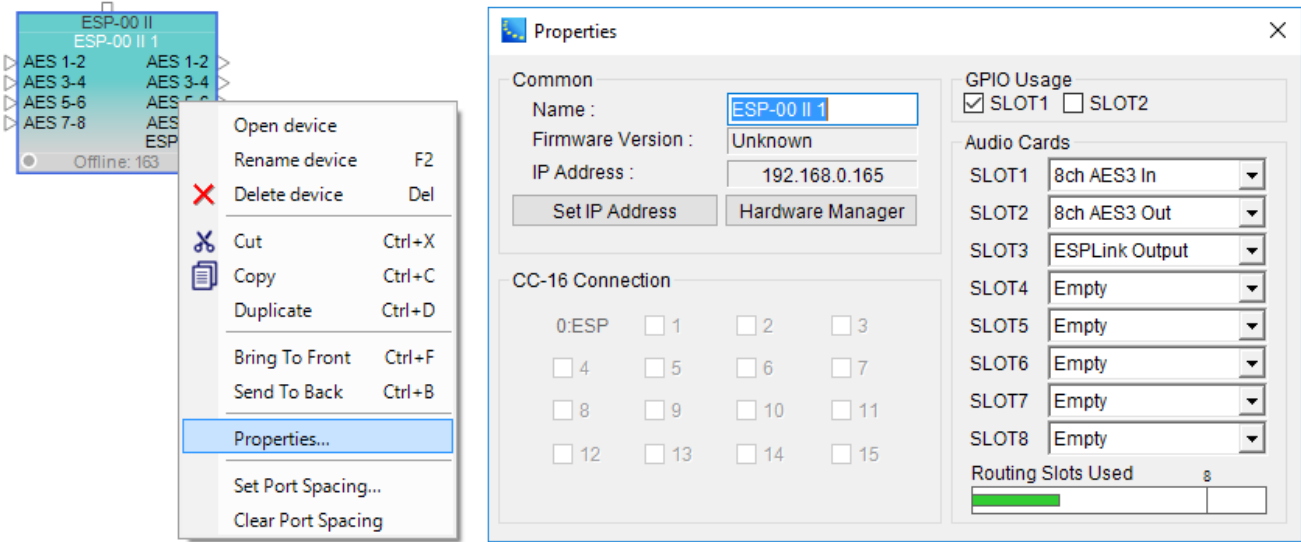

ESP-00 II Properties window with configured hardware

The Properties panel shows all of the items which determine the configuration of the ESP-00 II.

Common - Contains functions which are common to all ESP-00 II devices:

Name - The unique name of the ESP-00 II that is displayed within the Project View. This unique name is also used in serial protocol programming. The name can be changed by selecting the name and entering a new one. The name may also be changed using the right-click menu or the **F2** keyboard shortcut.

Firmware Version - Displays the current version of ESP-00 II firmware, if known. This item is only available when on-line with the ESP.

IP Address - Displays the current IP address for the ControlSpace Network port.

Set IP Address - Clicking this button allows you to change the IP address of the device.

Hardware Manager - Clicking this button opens the **Hardware Manager** dialog.

CC-16 Connection - Displays a check mark beside numbers 1 through 15 matching the device ID of each CC-16 connected to the ESP-00 II.

GPIO Usage - Check boxes to enable the general purpose input and output capabilities:

GPIO SLOT 1 - Eight control inputs and eight control outputs are provided in each ESP-00 II system as standard equipment.

GPIO SLOT 2 - An optional connector card and cable to add eight control inputs and eight control outputs to an ESP-00 II.

Audio Cards - SLOT1 to SLOT8 represent physical hardware slots that can be populated with expansion cards from within the ControlSpace® ESP-00 II architecture.

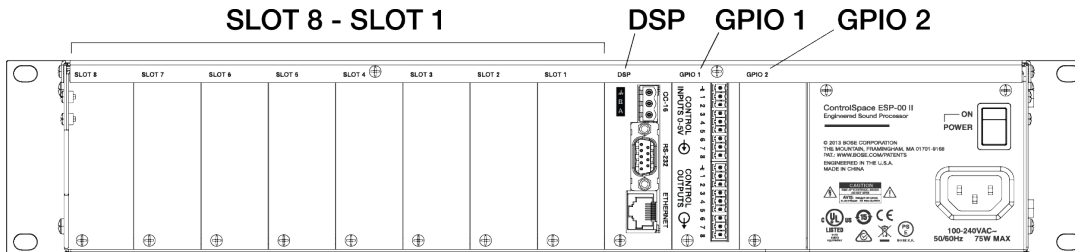

ESP-00 II Rear I/O Panel

SLOT 1 - SLOT 8 - Within the audio card options, each slot has a drop down menu which lists the audio cards which may be installed:

- 4ch Mic/Line Input II
- 4ch Line Output II
- 4x4 Mic/Line In
- 4ch EDR In
- 4ch EDR Out
- 8ch AES3 In
- 8ch AES3 Out
- 4ch Mic/Line In
- 4ch SDR Output
- Surround
- CobraNet 16In16Out
- CobraNet 16In8Out
- CobraNet 8In16Out

CobraNet 8In8Out
 CobraNet 16In
 CobraNet 16Out
 CobraNet 8In
 CobraNet 8Out
 ESPLink Output
 Dante 16in16out
 Dante 8in8out
 Dante 16in
 Dante 16out
 Dante 8in
 Dante 8out

Routing Slots Used – A single ESP-00 II can accommodate up to 64 channels of audio. Each card uses some quantity of the 64 channels. The bar graph indicates the current channel usage, and will turn red if the 64 channel maximum has been exceeded.

ESP-00 II Audio Card Control Panels

4ch Mic/Line Input II

This expansion card provides four analog microphone or line level input channels.

Adjustable options may be changed in the control panel for the card. The control panel can be opened by double clicking on one of the input blocks that are associated with the card in Signal Processing View.

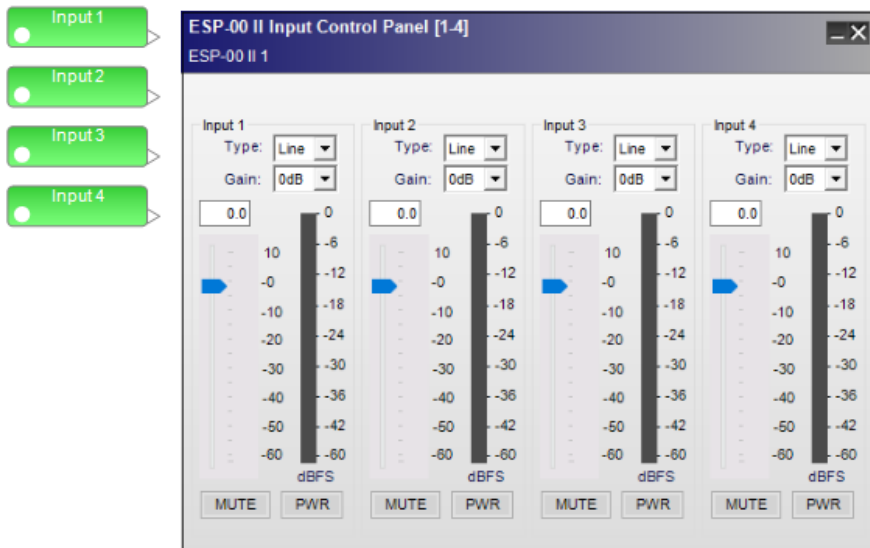

4ch Mic/Line Input Control Panel

The **Input Control Panel** provides the following options:

Input 1-4 Label - Displays the channel name as defined by the user within Signal Processing View. Labels may be changed by highlighting the input block in Signal Processing View, then using the F2 key, right-click menu, or the Properties window.

Pre-Gain Control - Allows the selection of a pre-defined amount of analog input gain (0, 14, 24, 32, 44, 54, or 64dB).

Input Level Entry – Permits direct entry of desired input signal level in dB. Range of adjustment matches and tracks the input gain slider.

Input Gain Slider– Adjusts the input signal level delivered to the next signal processing block. The range of adjustment is from $-\infty$ to +12dB. This adjustment point is in the digital domain, post analog to digital conversion.

Input Signal Meter - Displays the current input signal level in dBFS at the input to the next processor function. Input meters include a 'peak hold' indicator which is identified by a red line across the meter.

Mute– Silences the signal and disables audio from passing to the next signal processing block in the design. When Mute is enabled, the control panel button is Red.

PWR - When selected, engages the +48V phantom power.

4ch Line Output II

This expansion card provides four analog channels of line-level outputs.

Adjustable options may be changed in the control panel for the card. The control panel can be opened by double clicking on one of the output blocks that are associated with the card in the Signal Processing View.

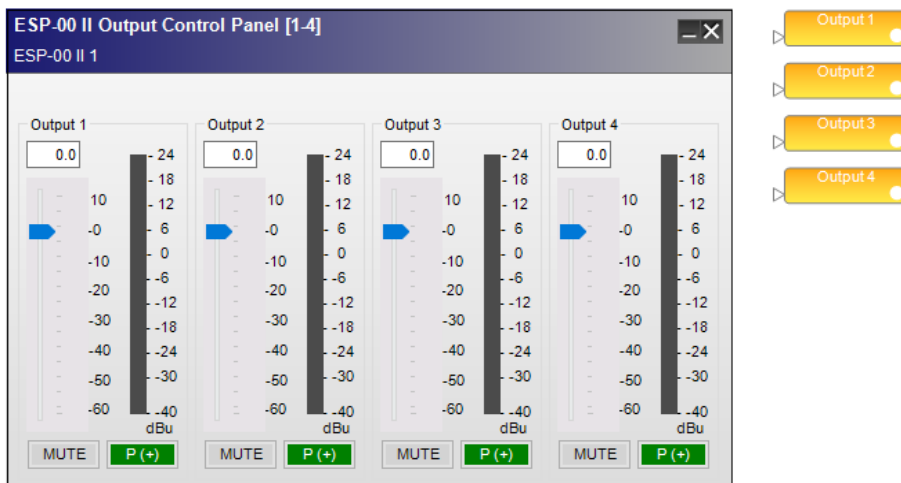

4ch Line Output Control Panel

The **Output Control Panel** provides the following options:

Output 1-4 Label - Displays the channel name as defined by the user within Signal Processing View. Labels may be changed by highlighting the input block in **Signal Processing** View, then using the **F2** key, right-click menu, or the **Properties** window.

Output Level Entry - Allows the direct entry of the amount of attenuation ($-\infty$ dB, min, to +12 dB, max, in increments of 0.5 dB) applied to the output signal.

Output Gain Slider– Adjusts the output signal level delivered to the analog output. The range of adjustment is from $-\infty$ to +12dB.

Output Signal Meter - Displays the current output signal level in dBFS at the input to the next processor function. Output meters include a 'peak hold' indicator which is identified by a red line across the meter.

Mute– Silences the signal and disables audio from passing to the analog output. When **Mute** is enabled, the control panel button is red.

Signal Polarity Control - Inverts the polarity of the signal. Default value is positive (+) or non-inverted. When selected, the signal polarity is negative (-) or inverted. Button color is used to indicate current state with green being non-inverted and red being inverted.

4x4 Mic/Line Input/Output Card

This expansion card provides four microphone or line-level standard dynamic range (SDR) input channels and four SDR line level output channels.

Adjustable options may be changed in the control panels for the card. The control panels can be opened by double clicking on one of the input or output blocks that are associated with the card in Signal Processing View.

Input Control Panel

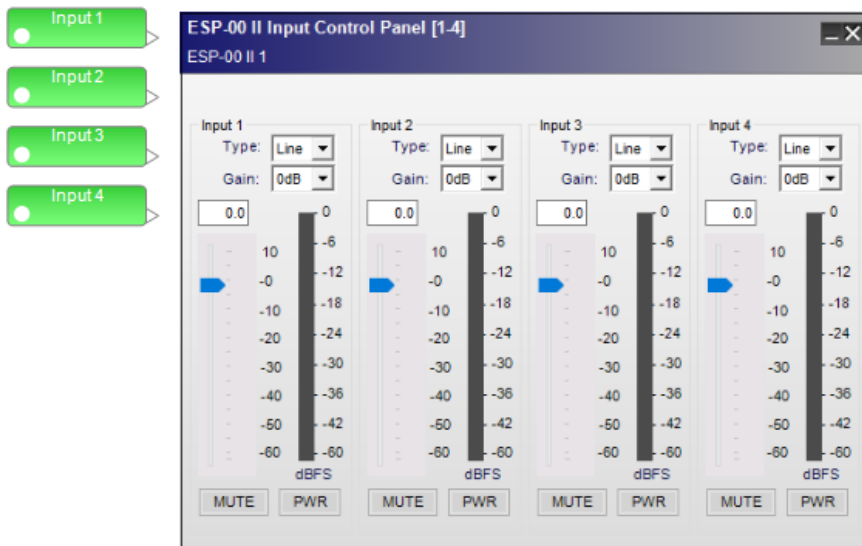

4x4 Mic/Line Input Control Panel

The **Input Control Panel** provides the following options:

Input 1-4 Label - Displays the channel name as defined by the user within the Signal Processing View of the ESP. Labels may be changed by highlighting the input block in Signal Processing View, then using the F2 key, right-click menu, or the Properties window.

Input Type Selection - Provides a selector to configure the range of input pre-gain values for typical **Line** and **Mic** input signal types. This adjustment is in the analog domain, before analog to digital conversion.

Input Gain - Offers selectable gain options based upon the input type selection. The gain values for **Line** inputs are, 0dB (no additional gain), 14dB, and 24dB. Gain values for **Mic** inputs are, 42dB, 48dB, 54dB, and 64dB.

Input Level Entry udB. Range of adjustment matches and tracks the input gain slider.

Input Gain Slider - Adjusts the input signal level delivered to the next signal processing block. The range of adjustment is from $-\infty$ to +12dB. This adjustment point is in the digital domain, post-analog to digital conversion.

Input Signal Meter - Displays the current input signal level in dBFS at the input to the next processor function. Input meters include a 'peak hold' indicator which is identified by a red line across the meter.

Mute– Silences the signal and disables audio from passing to the next signal processing block in the design. When **Mute** is enabled, the control panel button is Red.

PWR – When selected, engages the +48V phantom power. When phantom power is enabled, the control panel button is Green.

Output Control Panel

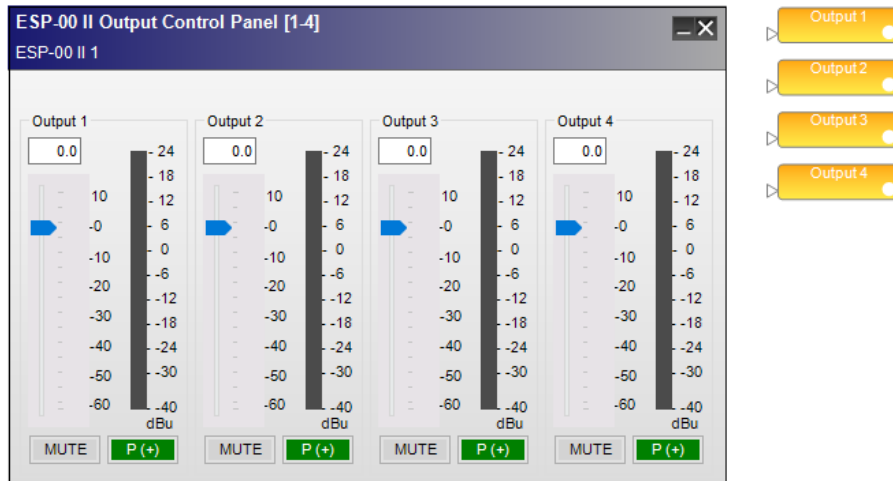

4x4 Mic/Line Output Control Panel

The **Output Control Panel** provides the following options:

Output 1-4 Label - Displays the channel name as defined by the user within Signal Processing View. Labels may be changed by highlighting the output block in Signal Processing View, then using the F2 key, right-click menu, or the Properties window.

Output Level Entry - Allows the direct entry of the amount of attenuation (-60 dB, min, to +12 dB, max, in increments of 0.5 dB) applied to the output signal.

Output Gain Slider– Adjusts the output signal level delivered to the next analog output dB.

Output Signal Meter - Displays the current output signal level in dBFS at the input to the next processor function. Output meters include a 'peak hold' indicator which is identified by a red line across the meter.

Mute– Silences the signal and disables audio from passing to the next analog output. When **Mute** is enabled, the control panel button is red.

Signal Polarity Control - Inverts the polarity of the signal. Default value is positive (+) or non-inverted. When selected, the signal polarity is negative (-) or inverted. Button color is used to indicate current state with green being non-inverted and red being inverted.

4ch EDR Input Card

This card provides four channels of enhanced dynamic range (EDR) highest quality line-level input.

Adjustable options may be changed in the control panel for the card. The control panel can be opened by double clicking on one of the input blocks that are associated with the card in Signal Processing View.

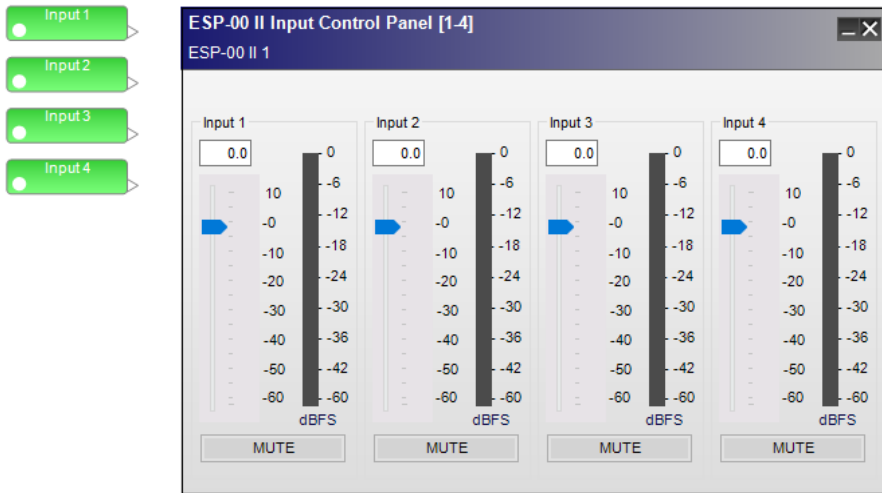

EDR line-level input card control panel

The **Input Control Panel** provides the following options:

Input 1-4 Label - Displays the channel name as defined by the user within the Signal Processing View of the ESP. Labels may be changed by highlighting the input block in Signal Processing View, then using the F2 key, right-click menu, or the Properties window.

Input Gain Slider- Adjusts the input signal level delivered to the next signal processing block. The range of adjustment is from $-\infty$ to +12dB. This adjustment point is in the digital domain, post analog to digital conversion.

Input Level Text Entry - Permits direct entry of desired input signal level in dB. Range of adjustment matches and tracks the input gain slider.

Input Signal Meter - Displays the current input signal level in dBFS at the input to the next signal processing block.

Mute- Silences the signal and disables audio from passing to the next signal processing block in the design. When **Mute** is enabled, the control panel button is red.

4ch EDR Output Card

This card provides four channels of line-level enhanced dynamic range (EDR) highest quality output.

Adjustable options may be changed in the control panel for the card. The control panel can be opened by double clicking on one of the output blocks that are associated with the card in Signal Processing View.

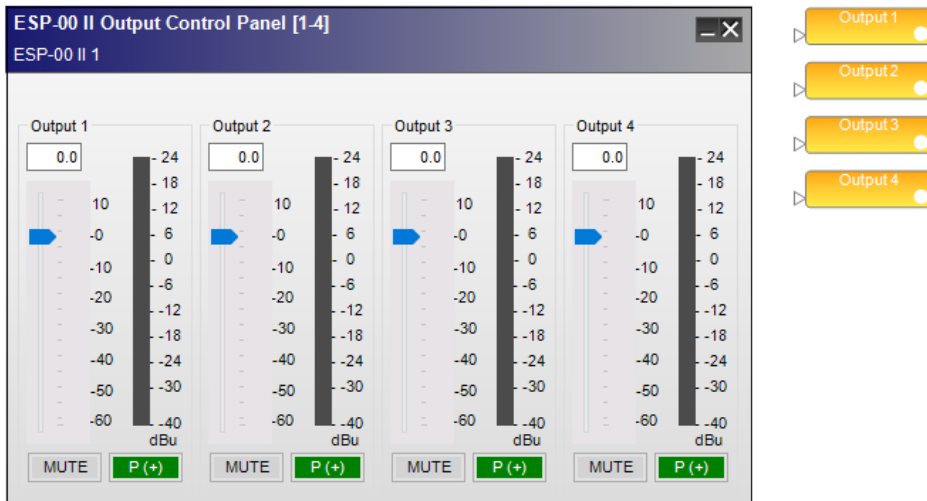

EDR output card control panel

The **Output Control Panel** provides the following options:

Output 1-4 Label - Displays the channel name as defined by the user within the Signal Processing View. Labels may be changed by highlighting the input block in Signal Processing View, then using the F2 key, right-click menu, or the Properties window.

Output Level Text Entry - Allows the entry of the amount of attenuation (-60 dB, min, to +12 dB, max, in increments of 0.5 dB) applied to the output signal.

Output Gain Slider - Adjusts the output signal level delivered to the next analog output. The range of adjustment is from $-\infty$ to +12dB.

Output Signal Meter - Displays the current output signal level in dBFS at the input to the next analog output. Output meters include a 'peak hold' indicator which is identified by a red line across the meter.

Mute - Silences the signal and disables audio from passing to the next gain stage in the design. When **Mute** is enabled, the control panel button is red.

Signal Polarity Control - Inverts the polarity of the signal. Default value is positive (+) or non-inverted. When selected, the signal polarity is negative (-) or inverted. Button color is used to indicate current state with green being non-inverted and red being inverted.

8ch AES3 Input Card

This expansion card provides eight channels of AES3 digital audio input.

Adjustable options may be changed in the control panel for the card. The control panel can be opened by double clicking on one of the input blocks that are associated with the card in Signal Processing View.

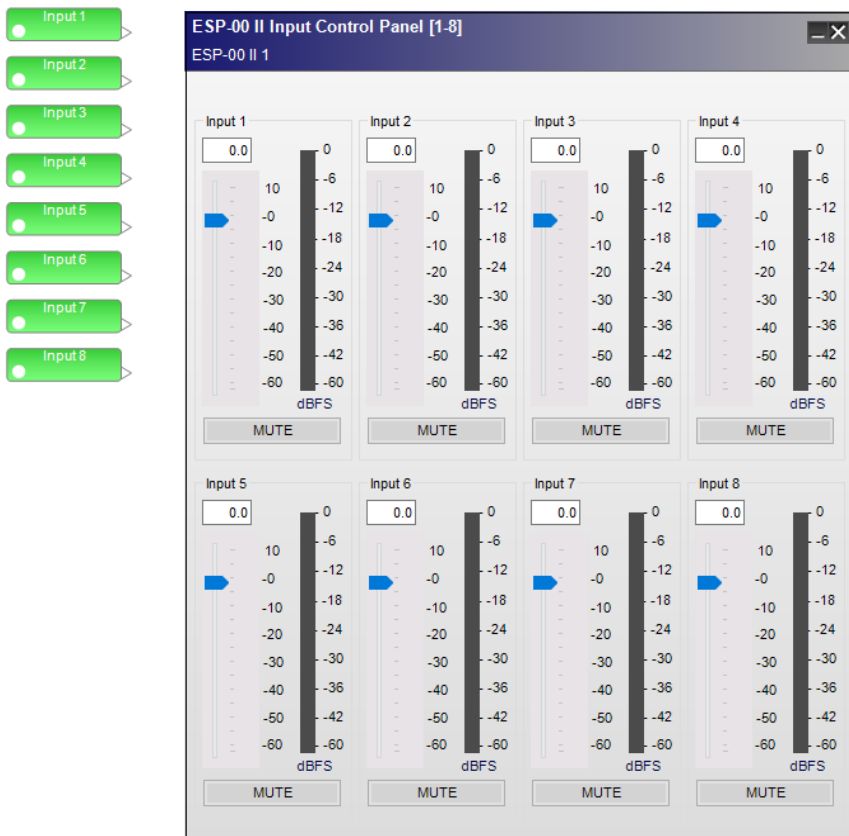

AES3 eight-channel input card control panel

The **input control panel** provides the following options for each channel:

Input 1-8 Label - Displays the channel name as defined by the user within the Signal Processing View of the ESP. Labels may be changed by highlighting the input block in **Signal Processing View**, then using the **F2** key, right-click menu, or the **Properties** window.

Input Gain Slider - adjusts the input signal level delivered to the next signal processing block. The range of adjustment is from $-\infty$ to +12dB. This adjustment point is in the digital domain, post analog to digital conversion.

Input Gain Value - permits direct entry of desired input signal level in dB. Range of adjustment matches and tracks the input gain slider.

Mute - silences the signal and disables audio from passing to the next signal processing block. When **Mute** is enabled, the control panel button is red.

8ch AES3 Output Card

This expansion card provides eight channels of AES3 digital audio output.

Adjustable options may be changed in the control panel for the card. The control panel can be opened by double clicking on one of the output blocks that are associated with the card in Signal Processing View.



AES3 eight-channel output card control panel

The **output control panel** provides the following options for each channel:

Output 1-8 Label - Displays the channel name as defined by the user within the Signal Processing View of the ESP. Labels may be changed by highlighting the input block in **Signal Processing View**, then using the **F2** key, right-click menu, or the **Properties** window.

Output Gain Slider - adjusts the output signal level delivered to the AES digital output dB. This adjustment point is in the digital domain, pre-digital to analog conversion.

Polarity - applies a reversal of polarity to the output signal. When *Polarity* is normal, the control panel button is Green and a "+" sign is present. When Polarity is reversed, the control panel button is Red and a "-" sign is present.

Mute - silences the signal and disables audio from passing to the AES digital output. When **Mute** is enabled, the control panel button is red.

4ch Mic/Line Input Card

This card provides four microphone or line-level standard dynamic range (SDR) input channels.

Adjustable options may be changed in the control panel for the card. The control panel can be opened by double clicking on one of the input blocks that are associated with the card in Signal Processing View.

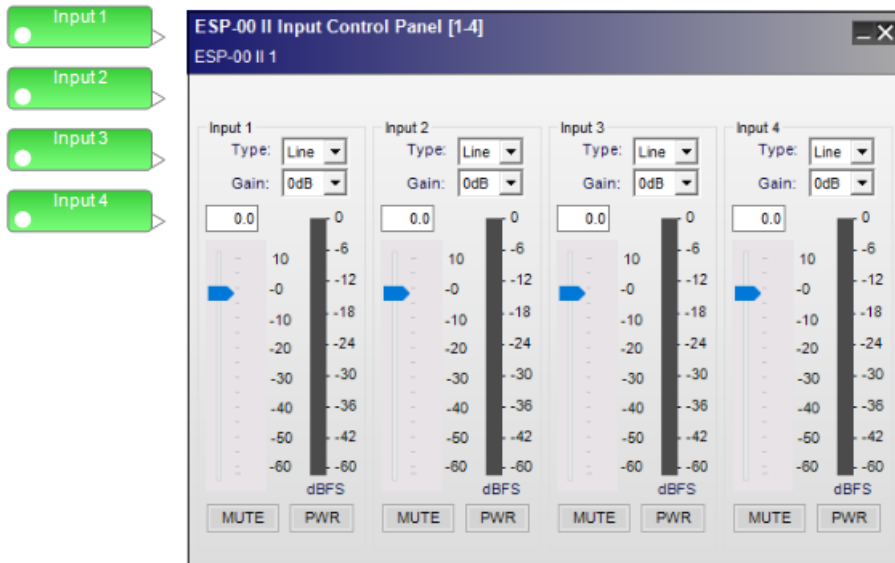

Four-channel mic/line SDR input card control panel

The **Input Control Panel** provides the following options:

Input 1-4 Label - Displays the channel name as defined by the user within the Signal Processing View of the ESP. Labels may be changed by highlighting the input block in Signal Processing View, then using the F2 key, right-click menu, or the Properties window.

Input Type Selection - Provides a selector to configure the range of input pre-gain values for typical **Line** and **Mic** input signal types. This adjustment is in the analog domain, before analog to digital conversion.

Input Gain - Offers selectable gain options based upon the input type selection. The gain values for **Line** inputs are, 0dB (no additional gain), 14dB, and 24dB. Gain values for **Mic** inputs are, 42dB, 48dB, 54dB, and 64dB.

Input Level Text Entry - Permits direct text entry of desired input signal level in dB. Range of adjustment matches and tracks the input gain slider.

Input Gain Slider - Adjusts the input signal level delivered to the next signal processing block. The range of adjustment is from $-\infty$ to +12dB. This adjustment point is in the digital domain, post analog to digital conversion.

Input Signal Meter - Displays the current input signal level in dBFS at the input to the next signal processing block. Input meters include a 'peak hold' indicator which is identified by a red line across the meter.

Mute - Silences the signal and disables audio from passing to the next signal processing block. When **Mute** is enabled, the control panel button is Red.

PWR - When selected, engages the +48V phantom power. When phantom power is enabled, the control panel button is Green.

4ch SDR Output Card

This card provides four line-level standard dynamic range (SDR) output channels.

Adjustable options may be changed in the control panel for the card. The control panel can be opened by double clicking on one of the output blocks that are associated with the card in Signal Processing View.

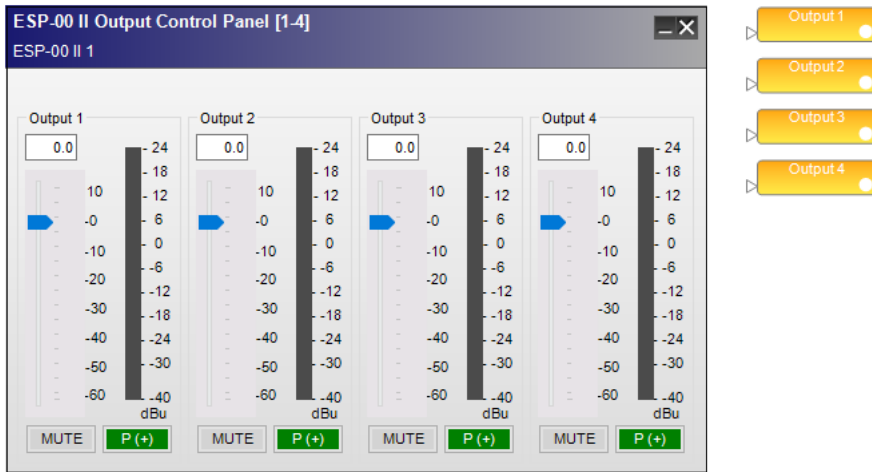

Four-channel SDR output card control panel

The **Output Control Panel** provides the following options:

Output 1-4 Label - Displays the channel name as defined by the user within the Signal Processing View. Labels may be changed by highlighting the input block in Signal Processing View, then using the F2 key, right-click menu, or the Properties window.

Output Level Entry - Allows the entry of the amount of attenuation (-60 dB, min, to +12 dB, max, in increments of 0.5 dB) applied to the analog output.

Output Gain Slider - Adjusts the output signal level delivered to the analog output. The range of adjustment is from $-\infty$ to +12dB.

Output Signal Meter - Displays the current output signal level in dBFS at the input to the next processor function. Output meters include a 'peak hold' indicator which is identified by a red line across the meter.

Mute - Silences the signal and disables audio from passing to the analog output. When **Mute** is enabled, the control panel button is red.

Signal Polarity Control - Inverts the polarity of the signal. Default value is positive (+) or non-inverted. When selected, the signal polarity is negative (-) or inverted. Button color is used to indicate current state with green being non-inverted and red being inverted.

Surround Sound

Surround Sound Decoder Input Card

The surround sound decoder card allows direct connection to the optical or coaxial S/PDIF connection of a CD or DVD player and decodes PCM, Dolby Digital and DTS audio formats.

The surround processing block provides eight outputs for the various surround channels decoded at its input and are labeled as follows:

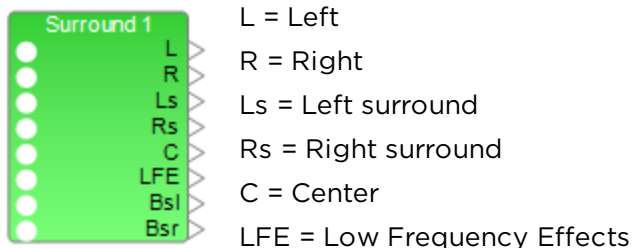

Bsl = Back surround left

Bsr = Back surround right

Adjustable options for this card are accessed by double clicking on the appropriate processing block within **Signal Processing View** to open the surround control panel.

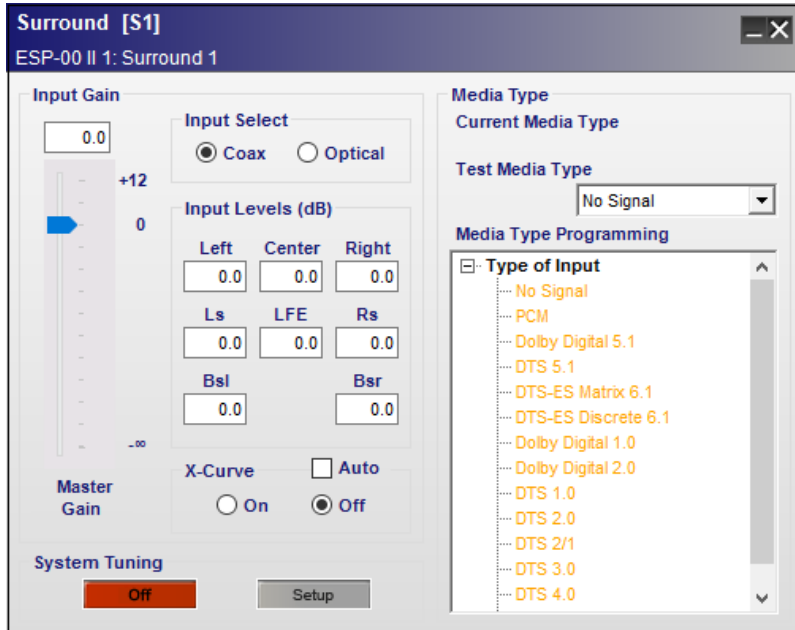

Surround Sound Decoder Input Card input block and control panel

The surround control panel provides the following options:

Input Gain - contains adjustable values for multi-channel surround sound input signals. Included in this section are:

Master Gain Slider - adjusts the overall signal level delivered to the signal processing blocks. The range of adjustment is from $-\infty$ to +12dB.

Master Gain Input Value - permits direct entry of desired input signal level in dB. Range of adjustment matches and tracks the input master gain slider.

Input Select - determines which input connector to use for S/PDIF surround sound signal decoding. The optical and coaxial inputs may be connected to devices. The active input can be switched by using control functions such as a parameter set or serial control. Options include:

Coax - an unbalanced RCA

Optical - a TOSLINK optical connector is used for this type of digital audio input.

Input Levels (dB) - permits individual input channel adjustment for each of the eight surround channels. Type a value directly into the level box or right-click on the field to access a gain slider. Individual channels supported are:

Left	Center	Right
Left Surround (Ls)	Low-Frequency Effects (LFE)	Right Surround (Rs)
Back Surround Left (Bsl)		Back Surround Right (Bsr)

X-Curve - equalization can be applied to all signal channels without using DSP resources in the ESP. Options in this section include:

On - enables the X-Curve to all channels.

Off - disables the X-Curve to all channels.

Auto - configures the decoder to automatically activate X-Curve equalization based on the room-type encoding in the media.

NOTE: When the decoder detects content with an X-Curve encoding, X-Curve is engaged. The **On** and **Off** buttons indicate the current state of the X-Curve EQ when online.

System Tuning -assists with surround system setup by sending test sources to individual channels which simplifies surround sound tuning and verification. Options in this section include:

On / Off - enables system tuning mode when **On** and routes the current playback source to surround outputs. When **Off**, the current playback source is disconnected from surround outputs.

Setup - opens the system tuning control panel.

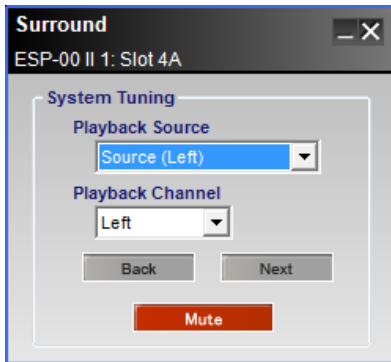

Surround Sound Decoder Input Card system tuning control panel

Options in this control panel include:

Playback Source - provides a drop-down list to determine which surround card input channel is routed to the decoder. Input options available are:

Source (Left) - Left channel only

Source (Left+Right) - Both left and right channels

Source (Center) - Center channel only

Source (Pink Noise) - Pink noise is used as the input signal

Playback Channel - provides a drop-down list to determine which individual surround output channels receive the chosen **Source**. The list is ordered as:

Left - Left front

Center - Center front

Right - Right front

Rs - Right surround

Bsr -Back surround right

Bsl -Back surround left

Ls - Left surround

LFE - Low Frequency Effects

Back - is a quick-select button to enable the surround output above the currently active output in the list above. When the top of the list is reached, the next button press jumps to the output the bottom of the list and continues moving up the list on each press.

Next - is a quick-select button to enable the surround output below the currently active output in the list above. When the top of the list is reached, the next button press jumps to the output the top of the list and continues moving down the list on each press.

Mute – when enabled, the button turns red and all surround outputs are muted. This is the default condition when **System Tuning** is turned **ON**. When disabled, the button turns gray and the currently defined **Playback Channel** becomes active.

Media Type – this section provides monitoring, programming, and testing of various media-based events. Options available within this area of the surround sound control panel include:

Current Media Type - displays the type of media format that is detected at the surround card inputs. This state is updated when connected to an ESP and in **on-line** mode. It will appear blank while in **off-line** mode.

Test Media Type – is used to select a media type from the drop-down list to invoke and verify the actions assigned to that Media Type.

NOTE: The Test Media Type drop-down list is disabled when on-line.

Media Type Programming – is used to trigger a media type-specific parameter sets. When a specific input format is detected and decoded from the digital bitstream, the listed Media Type is recalled to perform the actions defined in its programming.

Individual media types are listed in the **Type of Input** tree and programming events are assigned to one or more types while off-line.

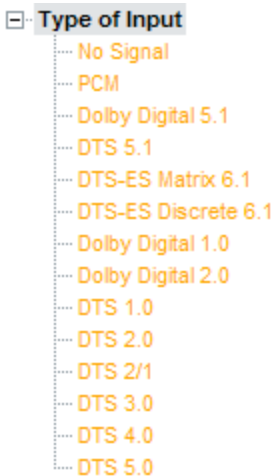

Surround Sound control panel Media Type of Input Tree

To associate a Parameter Set with a media type, drag the Parameter set onto the desired media type in the list. For example, one Parameter Set can be programmed to change the signal routing and provide some equalization for a stereo CD signal while another can be programmed to signal a projector to power on and lower the projection screen for a Dolby 5.1 DVD demonstration.

For more programming information, see **Parameter Sets**.

Media Types are identified and recalled based upon the signal format table shown below:

Format	Sample Rate	Media Type
Format	Sample Rate	Media Type
PCM (CD)	44.1 kHz	PCM
PCM (DVD Video)	48 kHz	PCM
Dolby Digital 1.0	48 kHz	Dolby Digital 1.0
Dolby Digital 2.0	48 kHz	Dolby Digital 2.0
Dolby Digital 5.1	48 kHz	Dolby Digital 5.1

Format	Sample Rate	Media Type
DTS 1.0	48 kHz	DTS 1.0
DTS 2.1	48 kHz	DTS 2.1
DTS 3.0	48 kHz	DTS 3.0
DTS 4.0	48 kHz	DTS 4.0
DTS 5.0	48 kHz	DTS 5.0
DTS 5.1	48 kHz	DTS 5.1
DTS ES Discrete 6.1	48 kHz	DTS ES Discrete 6.1
DTS ES Matrix 6.1	48 kHz	DTS ES Matrix 6.1
DTS CD	44.1 kHz	DTS 5.1

Channel Mapping Chart

Bit Stream	Channels							
	C	R	L	Rs	Ls	LFE	Rb	Lb
Dolby Digital 1.0								
Dolby Digital 2.0								
Dolby Digital 5.1								
DTS 1.0								
DTS 2.0								
DTS 2/1								
DTS 2/2								
DTS 3.0								
DTS 4.0								
DTS 5.0								
DTS 5.1								
DTS ES 6.1 Discrete								
DTS ES 6.1 Matrix								
PCM 16 bit (CD)								
PCM 24/48 bit								
DVD-Audio								
DTS-CDDA								

Surround Sound channel mapping

Functional Diagram

The following functional diagram depicts the signal flow and logic operation of the surround decoder input card.

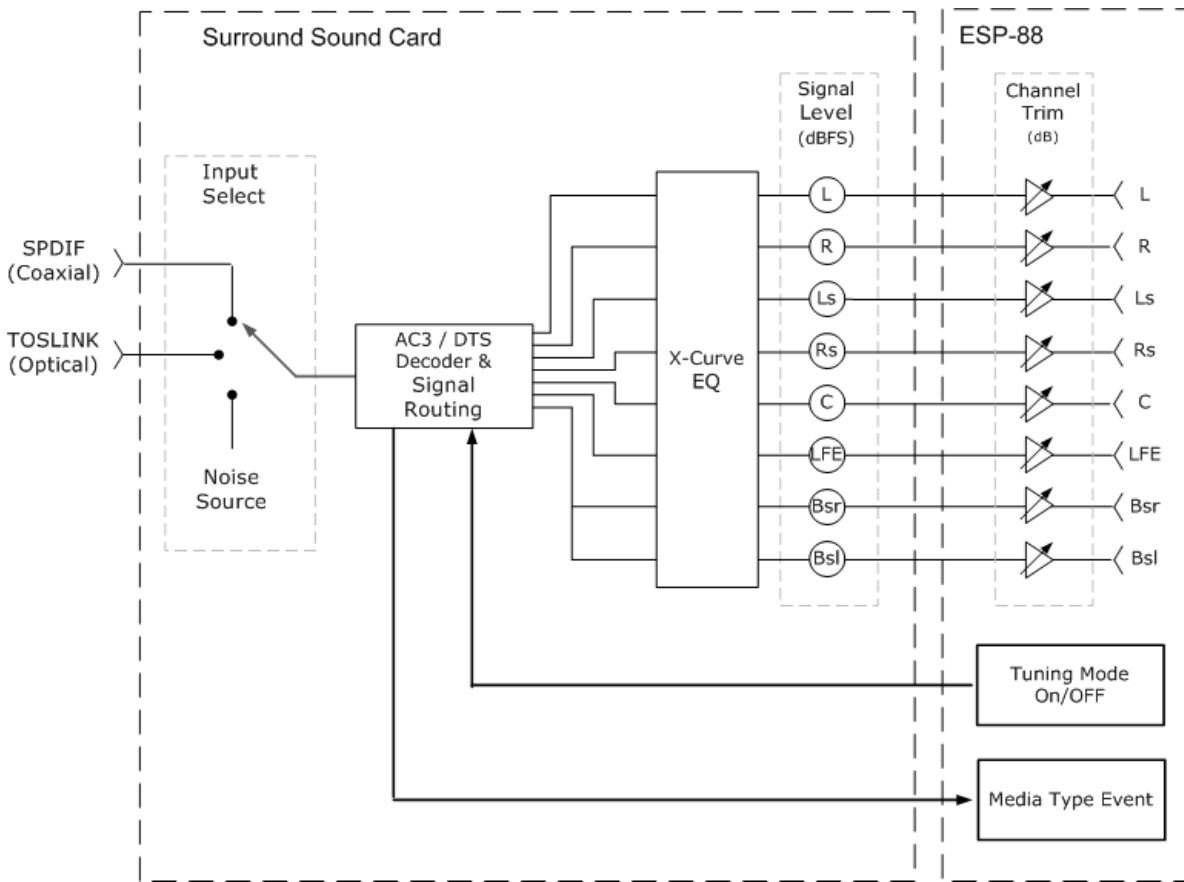

Surround Sound Decoder Input Card functional diagram

Surround Sound Decoder

The Bose® ControlSpace® Surround Sound Card offers new opportunities for integration of surround sound systems into commercial spaces. The flexibility of ControlSpace systems and the enhanced listening experience afforded by a surround sound system, makes for an impactful product solution. This application note illustrates basic surround sound system design principles and the implementation of a multi-purpose facility design, within a ControlSpace system.

The following concepts are explored:

- Surround sound system types
- Positioning surround sound loudspeakers
- Implementing a surround sound system
- Multi-purpose surround system design example

Background

We are more accustomed to the immersive listening experience provided by surround sound systems than ever before. They are used in many different types of venues from home theaters to movie theaters. These venues range in size from small spaces to large rooms, and the use of surround sound systems runs the gamut from multi-purpose implementations to highly specialized facilities. Figure 1 illustrates the four primary quadrants of surround sound venue implementation today.

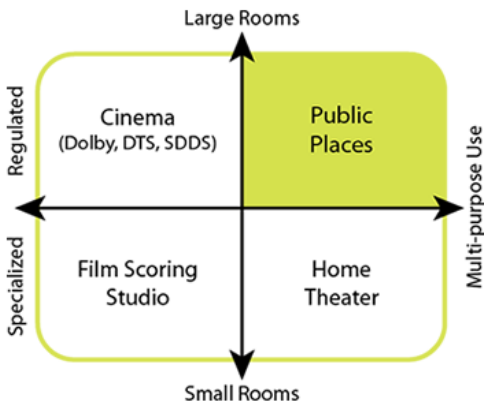

Figure 1: Typical surround sound system venues

Surround sound system types

The markets targeted by the new ControlSpace Surround Sound Card fit within the upper right-hand quadrant of this graph. Medium to large sized venues with multi-purpose needs are in the sweet spot for surround sound systems managed by ControlSpace. Knowing this, let's take a look at the basic surround sound configurations in today's marketplace.

Surround sound systems are referenced by the number of output channels they produce. The three most common today are named 5.1, 6.1, and 7.1. The first number of this classification indicates the number of full range signals in use. The .1 represents the number of Low Frequency Effect (LFE) channels in operation. The LFE output channel may also receive low frequency information from any of the full range channels when bass management is in effect. The loudspeaker arrangements associated with each of these surround sound system types are shown in Figure 2.

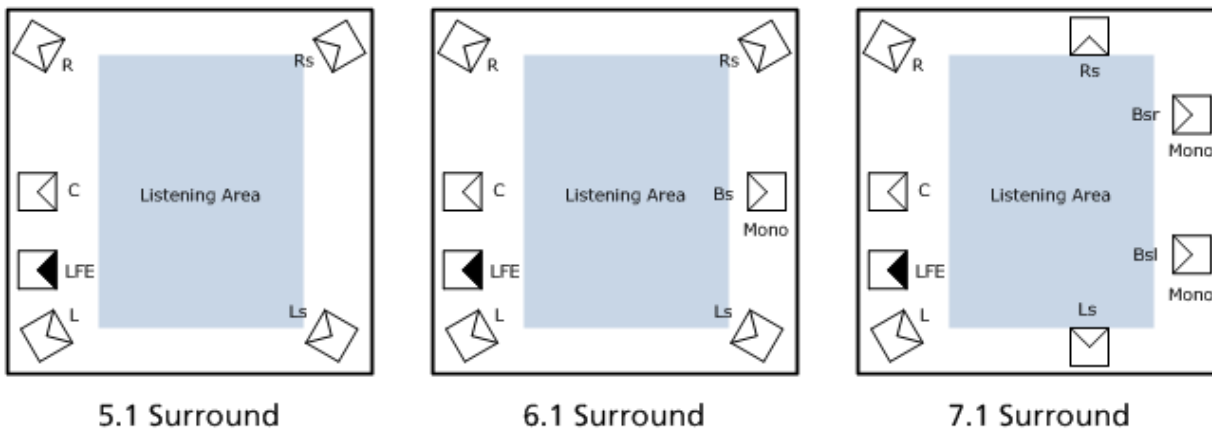

Figure 2: Surround sound system configurations

Positioning surround sound loudspeakers

When designing loudspeaker systems to reinforce a specific surround sound configuration, the following recommendations will help you position each device appropriately. Front channel loudspeakers (Left, Center, Right) should be positioned behind acoustically transparent projection screens and at a height 65% of the total screen height from its base.

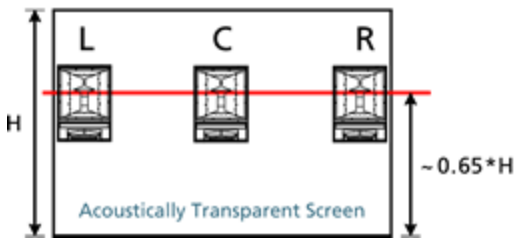

Figure 3: Loudspeakers behind screen

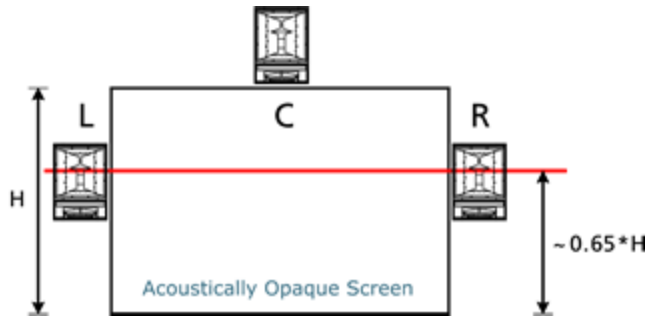

Figure 4: Loudspeakers around screen

When the projection screen is opaque, the same height rule applies to left and right loudspeakers, but they are oriented outside the perimeter of the screen to a location which will not obscure the on-screen image. The center channel loudspeaker is positioned above the screen in cases like this.

A Low Frequency Effects (LFE) loudspeaker should always be located near the front channel loudspeakers. Moving this loudspeaker away from the other front loudspeakers will reduce its impact and effectiveness during music and movie playback.

Bass Placement Within Room

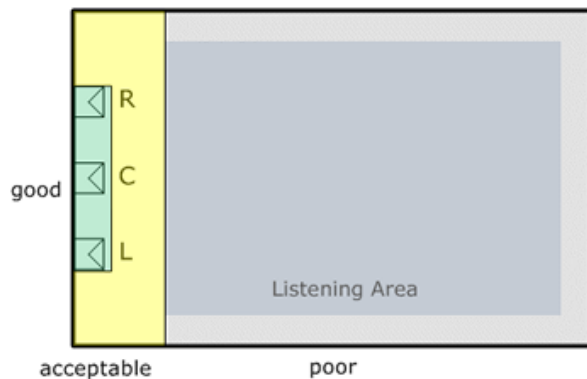

Figure 5: LFE performance area

The optimum LFE position is between the left and right loudspeakers and off axis from the center of the room. This will help to maximize low frequency energy throughout the listening space.

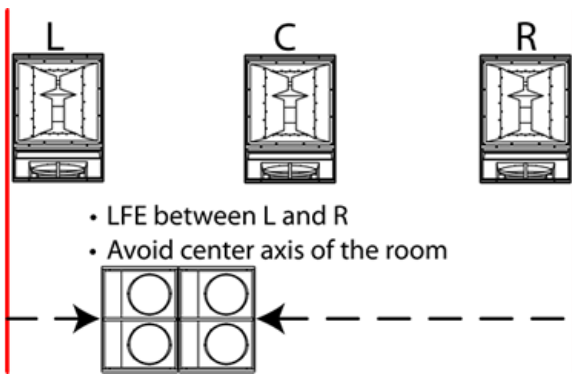

Figure 6: Recommended LFE positioning

Bi-amped loudspeakers are recommended for use with the front channels (L, C, R). The crossover range between the front channels and the LFE loudspeakers should be between 80 and 100 Hz. Each of the surround channel loudspeakers should be full range devices.

Using surround sound loudspeakers that have wider than traditional horizontal coverage, or Articulated Array® technology can enlarge the sweet spot, providing a better surround experience to a larger number of listeners. This becomes a critical factor in system designs for multi-purpose facilities using surround sound.

Bose® Panaray® 402®, Panaray 302™A, and FreeSpace® DS100SE loudspeakers all use Articulated Array technology and make excellent surround sound devices.

In the Multi-purpose surround system design example which we will explore in the following pages, a 7.1 system design option is chosen for maximum flexibility. The positioning of the loudspeakers supporting the surround channels also have rules of thumb to promote a quality experience.

In 7.1 surround systems, the right and left surround loudspeakers (Ls & Rs), which mount on the side walls, should be positioned at 66% of the distance from the projection screen to the back of the room. The back surround loudspeakers (Bsl & Bsr) mount on the back wall of the listening space and are located 25% of the total room width from the back corners.

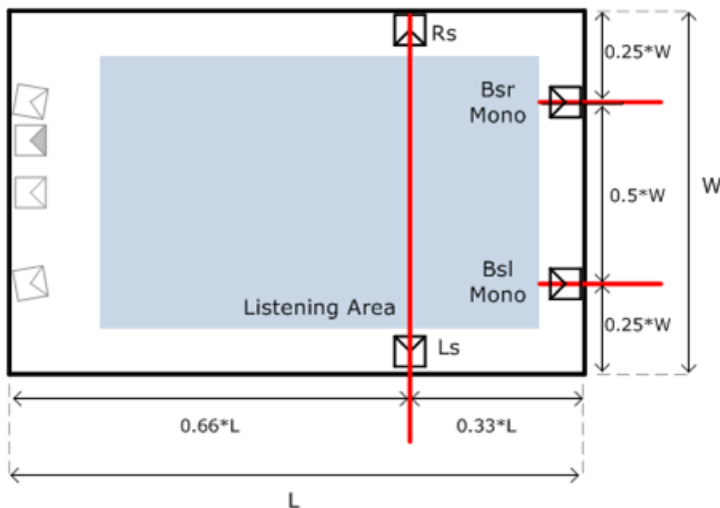

Figure 7: Surround loudspeaker location rules of thumb

Large rooms often require a signal delay applied to rear surround channels to ensure localization to the projected image on screen. Figure 8 illustrates this delay zone with a dashed red box in the rear one-third of the listening space.



Figure 8: Surround sound audio delay for video zone

Note: Surround zone delays should only be implemented during playback of video sources (movies). If DVD-Audio program material is active, this signal delay should be disabled. ControlSpace® systems support dynamic configuration of delays and all manner of related system adjustments that are warranted as the input program material changes its content.

Signal Processing Considerations

The use of Compressor/Limiter processing blocks within ControlSpace systems is strongly recommended to protect loudspeaker drivers. It is normal for action movies to dramatically vary the loudness of passages to achieve a desired effect. Without compression components in the signal chain, extremely loud passages can easily damage loudspeakers in short order.

The DSP power and flexibility of ControlSpace systems will help you dynamically manage signal delay to surround channels as digital program content changes, and when multi-purpose systems vary modes of operation, ControlSpace will adapt its configuration in real time, according to your design.

Please see our multi-purpose surround sound application note for methods to implement these concepts in a system configuration of a Bose® ControlSpace® ESP engineered sound processor.

CobraNet Input/Output Card

The Bose® ESP-00 II engineered sound processor is capable of supporting up to 64 audio channels divided into eight routing slots of up to eight channels each. Typically, an expansion card occupies one physical slot and provides four to eight channels of audio. One exception is the standard 4x4 input/output card which occupies two physical expansion slots (to allow enough space for the output connectors) but only requires one routing slot (eight channels total).

The CobraNet expansion card is unique as it only occupies one physical slot but can support up to 32 channels (16 in, 16 out) and can therefore utilize up to four of the eight available routing slots. For convenience the card can be configured to provide eight possible I/O combinations. This allows the card to be configured according to project requirements while leaving the maximum number of routing slots free for other expansion cards.

Depending on the number of routing slots allocated to the CobraNet card the number of additional expansion cards (other than the standard 4x4 card) that can be added may be less than the physical expansion slots available, as demonstrated in the table below.

CobraNet I/O Configuration	Routing Slots Used	Additional I/O Card Capacity
16 in, 16 out	4	4
16 in, 8 out	3	5

CobraNet I/O Configuration	Routing Slots Used	Additional I/O Card Capacity
8 in, 16 out	3	5
8 in, 8 out	2	6
16 in, 0 out	2	6
0 in, 16 out	2	6
8 in, 0 out	1	7
0 in, 8 out	1	7

Defining the CobraNet® Input/Output Card Configuration

The CobraNet card is added to the ESP-00 II in the same manner as other expansion cards. If the card has already been fitted it will be detected automatically when a hardware scan is performed, otherwise the card can be added manually as follows:

Right-click on the ESP icon in Project View and select **Properties** to display the ESP Properties dialog box.

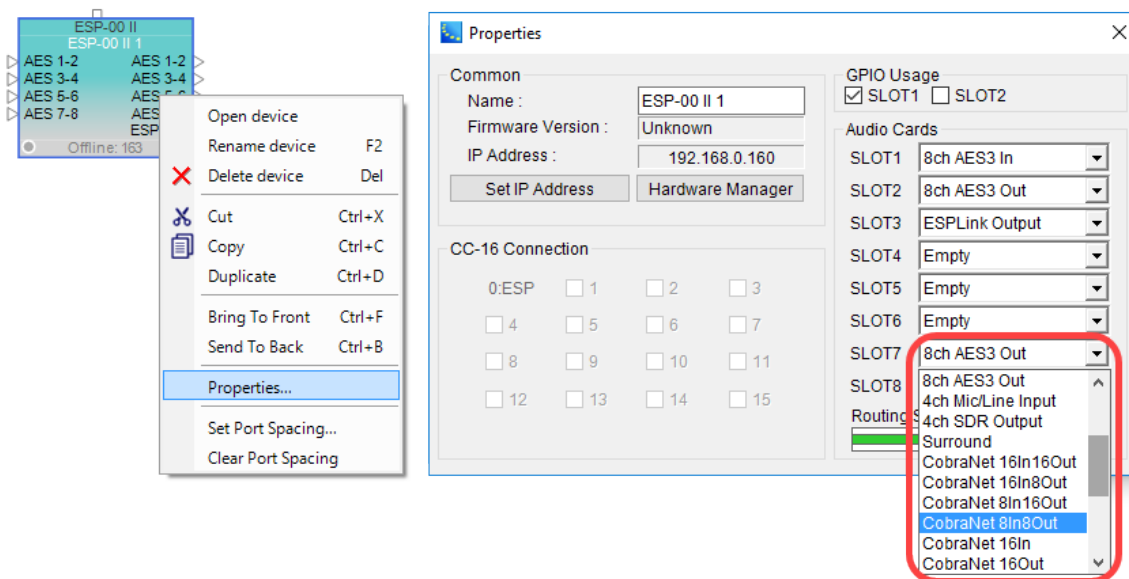

CobraNet Card Configuration within ESP Properties

Select the required CobraNet card variant from the drop-down list presented for the audio card slot where the card will be installed.

NOTE: Only one CobraNet I/O card may be installed within an ESP-00 II.

When used in conjunction with other expansion cards you will need to ensure that the eight available routing slots are not exceeded. If this occurs the **Routing Slots Used** meter will turn red as shown below:

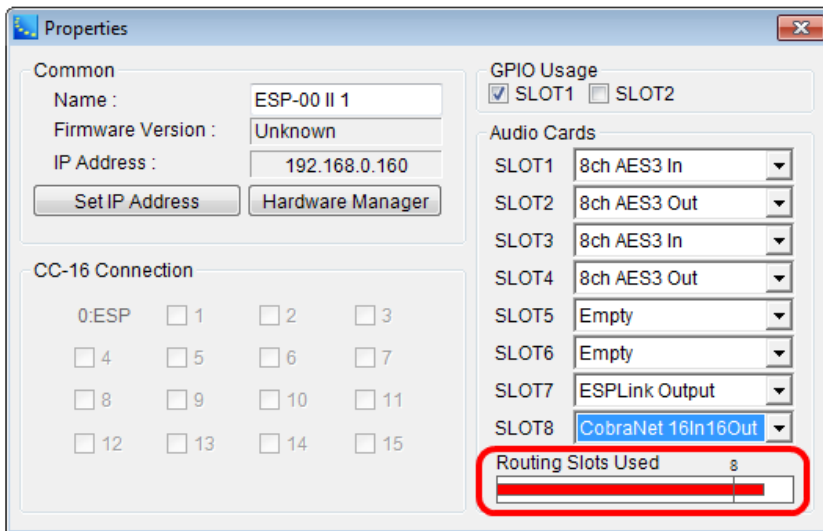

Indication of available routing slots exceeded

CobraNet Properties

The Properties window for the CobraNet expansion In card is accessible by right-clicking on any CobraNet input or output block the Signal Processing View and selecting **Properties**.

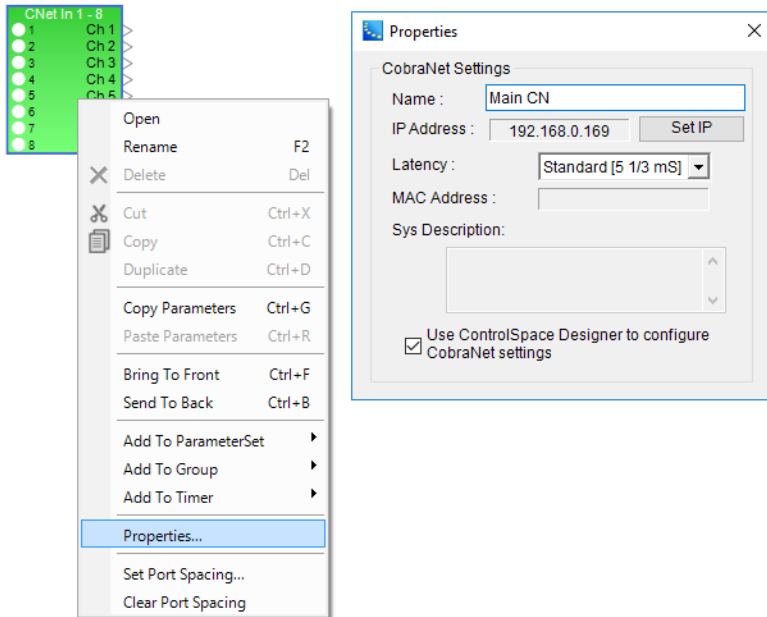

CobraNet Input/Output card properties

Name – can be any text description that is appropriate for the system design. This name is associated with the Cobranet properties and is not displayed in Signal Processing View.

IP Address – is equal to that of the host ESP plus eight (e.g. 192.168.0.168 for an ESP address of 192.168.0.160) but may be adjusted to any alternate address if necessary by clicking **Set IP**.

NOTE: An IP address is only necessary when the CobraNet card is managed by SNMP or similar network monitoring devices and is unreferenced in normal operation.

Latency – is a drop-down list providing selection between three standard latency modes used in CobraNet networks. Higher latencies provide more tolerance for network propagation delays. The latency modes provided are:

Standard (5 1/3 mS)

Low (2 2/3 mS)

Lowest (1 1/3 mS)

NOTE: All CobraNet devices on a network must use the same latency mode to transmit and receive audio correctly.

MAC Address – is a read-only field displaying the unique MAC address assigned to each individual CobraNet card during manufacture.

Sys Description – provides information about the CobraNet card circuitry version.

NOTE: Both MAC address and Sys Description are visible only after connecting to an ESP in on-line mode. Both fields appear blank while in off-line mode.

Use ControlSpace Designer to configure CobraNet settings – is checked by default. However, if access to advanced CobraNet properties is required, remove the check mark to disable ControlSpace Designer access to the CobraNet card. Thereafter, all configurations are performed via the network using the CobraNet Discovery utility or similar software management tool.

Adjustable options for the CobraNet Input Card are accessed by double clicking on the appropriate CobraNet block within **Signal Processing View** to open its channel control panel.

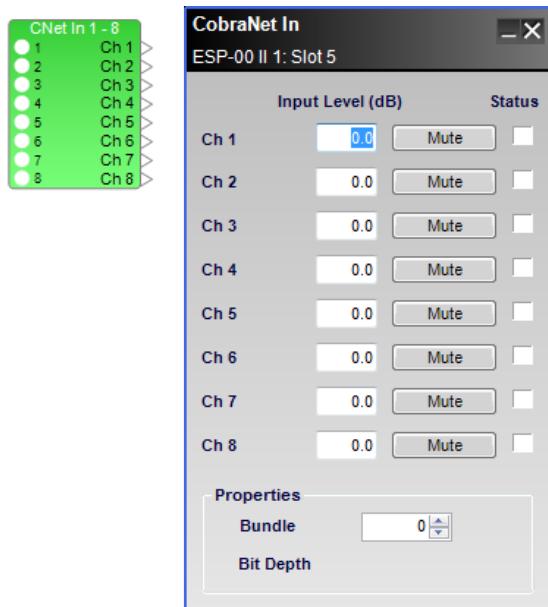

Eight-channel CobraNet card input control panel

Each eight-channel input control panel provides the following options for Ch 1 through Ch 8, the individually addressable **receivers** synchronizing with digital audio sent from other CobraNet transmitters.

Input Channel 1-8 - labels may be changed by selecting the input block in Signal Processing View, then using the Properties window.

Input Level (dB) – adjusts the input signal level delivered to the next signal processing block. The range of adjustment is from $-\infty$ to +12dB. This adjustment point is in the digital CobraNet domain. Type a value directly into the input level box or right-click on the field to access a gain slider.

Mute – silences the signal and disables audio from passing to the next signal processing block in the design. When Mute is enabled, the control panel button is Red.

Status – indicates presence of valid CobraNet data for each channel while ControlSpace Designer is on-line. The status colors represent the following conditions:

Black - Channel not being received

Green - Channel being received correctly

Red - Channel being received with errors (due to incorrect latency or network issues)

Properties – this area of the input control panel contains an adjustable field for entry of the CobraNet bundle.

Bundle – is an identification number from (0) to (65279) which matches the corresponding upstream *transmitter* of synchronized digital audio. The default value of (0) disables reception of network audio for as long as the port is unused.

Bit Depth – is read-only field and will be populated while ControlSpace Designer is on-line and audio is being received.

Adjustable options for the CobraNet Output card are accessed by double clicking on the appropriate CobraNet block within **Signal Processing View** to open its channel control panel.

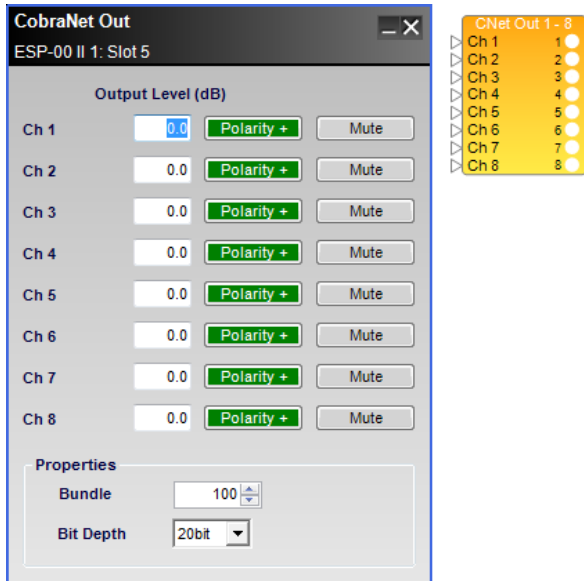

Eight-channel CobraNet card output control panel

Each eight channel output control panel provides the following options for CH 1 through Ch 8, the individually addressable *transmitters* sending synchronized digital audio to other CobraNet receivers.

Output Channel 1-8 - labels may be changed by selecting the input block in Signal Processing View, then using the Properties window.

Output Level (dB) – adjusts the output signal level delivered to the CobraNet digital output. The range of adjustment is from $-\infty$ to +12dB. This adjustment point is in the digital CobraNet domain. Type a value directly into the output level box or right-click on the field to access a gain slider.

Polarity – applies a reversal of polarity to the output signal. When Polarity is normal, the control panel button is Green and a plus (+) sign is present. When Polarity is reversed, the control panel button is Red and a minus (-) sign is present.

Mute – silences the signal and disables audio from passing to the next signal processing block in the design. When Mute is enabled, the control panel button is Red.

Properties – this area of the input control panel contains an adjustable field for entry of the CobraNet bundle.

Bundle – is an identification number from (0) to (65279) which matches the corresponding downstream *receiver* of synchronized digital audio. The default value of (0) disables reception of network audio for as long as the port is unused.

Bit Depth - adjusts the sample resolution for transmitted digital audio. The options are 16 bit (default), 20 bit and 24 bit. For proper audio synchronization, same Bit Depth should be used for receivers of the same bundle.

NOTE: A Bit Depth of 24 bit used with Standard [5 1/3mS] latency in the CobraNet card properties, reduces the number of channels in a Bundle to seven (7).

NOTE: For more information on configuring Bose professional system electronics for use with CobraNet network audio, refer to the CobraNet application notes available at pro.Bose.com.

8ch ESPLink Output Card

This card provides eight channels of digital audio output via TOSLINK optical connector.

Adjustable options may be changed in the control panel for the card. The control panel can be opened by double clicking the ESPLink output block that is associated with the card in Signal Processing View.

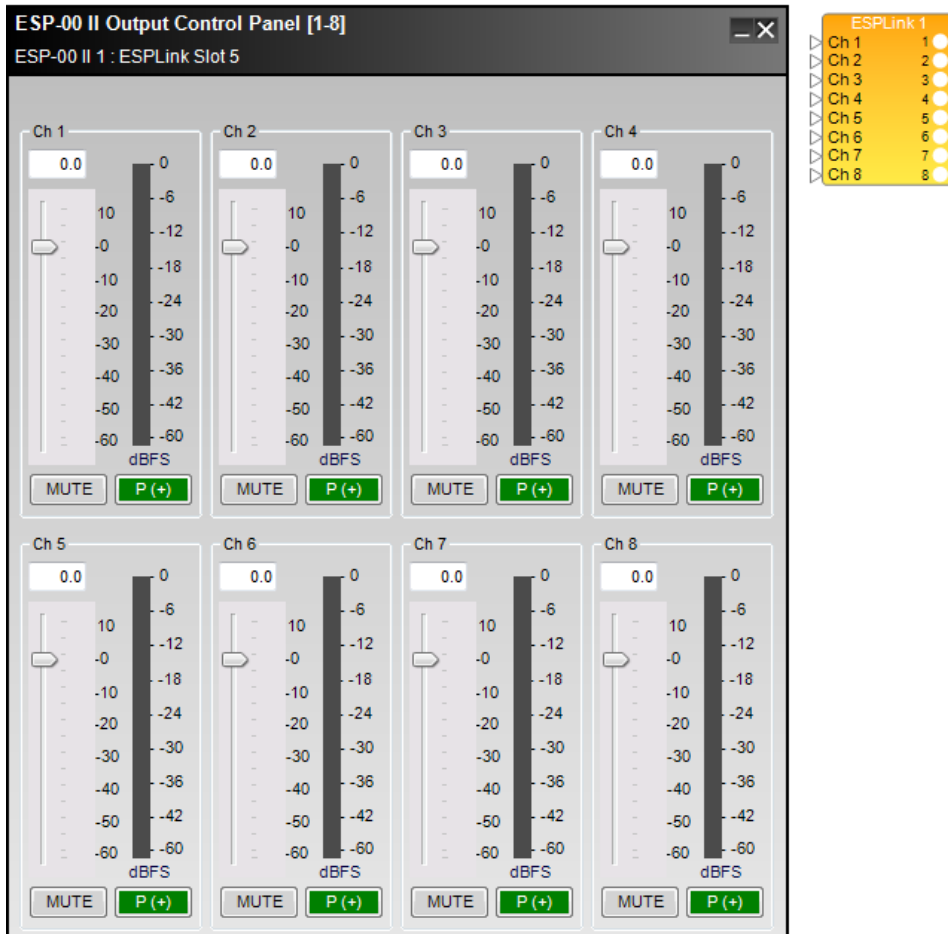

ESPLink Card output control panel

The **output control panel** provides the following options for each channel:

Output Channel 1-8 Labels - may be changed by selecting the input block in Signal Processing View, then using the Properties window.

Output Gain Slider - Adjusts the output signal level delivered to the ESPLink digital output. The range of adjustment is from $-\infty$ to +12dB. This adjustment point is in the digital domain, pre digital to analog conversion.

Output Signal Meter - Displays the output signal level in dBFS at the input to the next processor function.

Mute – Silences the signal and disables audio from passing to the ESPLink digital output. When **Mute** is enabled, the control panel button is Red.

Signal Polarity Control - Inverts the polarity of the signal. Default value is positive (+) or non-inverted. When selected, the signal polarity is negative (-) or inverted. Button color indicates current state with GREEN being non-inverted and RED being inverted.

Dante™ Network Card

The Bose ESP-00 II engineered sound processor is capable of supporting up to 64 audio channels divided into eight routing slots of up to eight channels each. The Dante digital audio network expansion card is unique as it only occupies one physical slot but can support up to 32 channels (16 in, 16 out) and can, therefore, utilize up to four of the eight available routing slots. For convenience, the card can be configured to provide eight possible I/O combinations. This allows the card to be configured according to project requirements while leaving the maximum number of routing slots free for other expansion cards.

Depending on the number of routing slots allocated to the Dante digital audio network card the number of additional expansion cards (other than the standard 4x4 card) that can be added may be less than the physical expansion slots available as demonstrated in following table.

I/O Configuration	Routing Slots Used	Additional I/O Card Capacity
16 in, 16 out	4	4
8 in, 8 out	2	6
16 in, 0 out	2	6
0 in, 16 out	2	6
8 in, 0 out	1	7
0 in, 8 out	1	7

For information on Dante networks and the Dante global properties control panel, see [Dante™ Network Device Properties](#).

Defining the Dante™ Card Configuration

The Dante digital audio network card is added to the ESP-00 II in the same manner as other expansion cards. If the card has already been fitted it will be detected automatically when a hardware scan is performed. Otherwise, the card can be added manually to the system design as follows:

In Project View, right-click on the ESP-00-II icon and select Properties to display the ESP-00-II Properties dialog box.

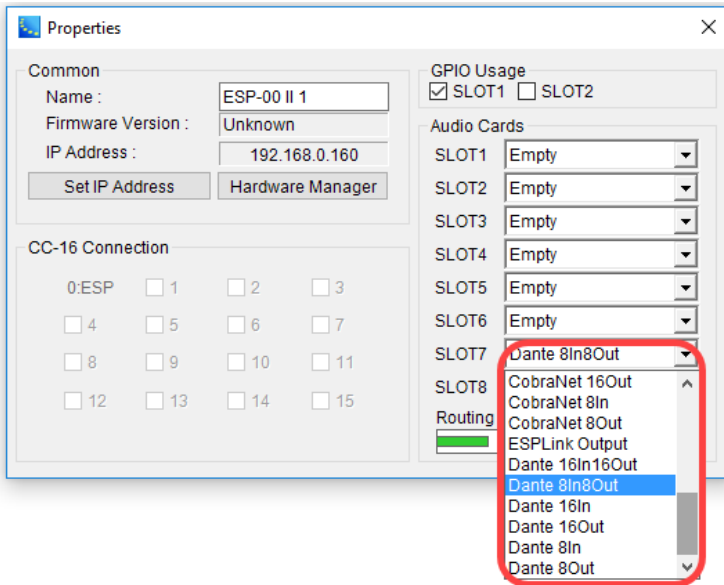

Dante Digital Audio network card configuration within ESP Properties

In the drop-down list, select the desired I/O configuration for the audio card slot where the card will be installed.

NOTE: Only one Dante network card or one CobraNet network may be installed in an ESP-00 II. The ESP-00-II does not support the bridging of different digital audio network types.

When used in conjunction with other expansion cards you will need to ensure that the eight available routing slots are not exceeded. If this occurs the Routing Slots Used meter will turn red as shown in the following example:

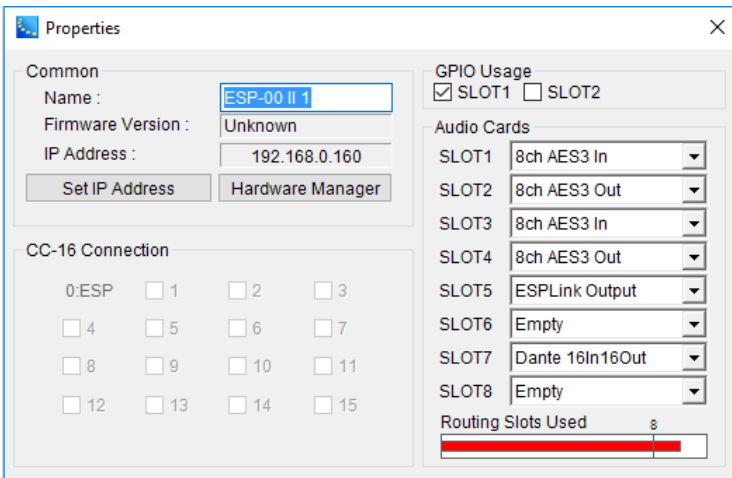

Indication of available routing slots exceeded

Dante Network Card Input/Output Control

The Dante digital audio network cards offer a basic set of input and output controls.

The input controls of the Dante card are accessed by double clicking on the appropriate Dante input block within the Signal Processing View of the ESP.

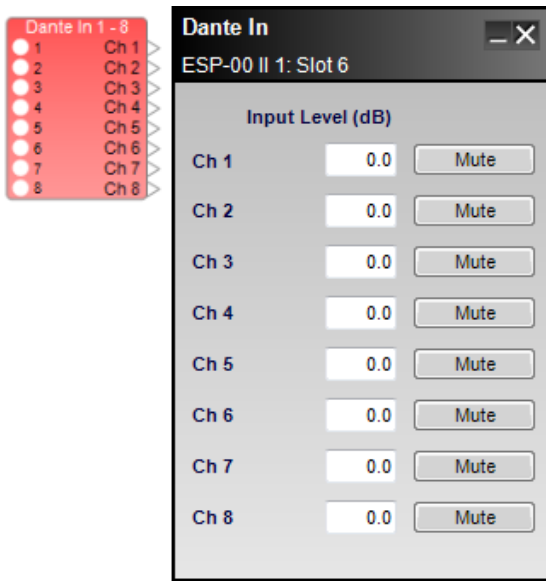

Example of eight-channel Dante network card input block and control panel

Each Dante input control panel provides the following controls:

Input Channel 1-*n* - labels may be changed by selecting the input block in Signal Processing View, then using the Properties window.

Input Level (dB) - adjusts the input signal level delivered to the next signal processing block. The range of adjustment is from $-\infty$ to +12dB. This adjustment point is in the digital domain. Type a value directly into the input level box or right-click on the field to access a gain slider.

Mute - silences the signal and disables audio from passing to the next signal processing block in the design. When Mute is enabled, the control panel button is Red.

Page Down/Page Up - Only for blocks that have more than 8 channels. Use these controls to scroll forward or backward through the channels.

The output controls of the Dante card are accessed by double clicking on the appropriate Dante output block within the Signal Processing View of the ESP.

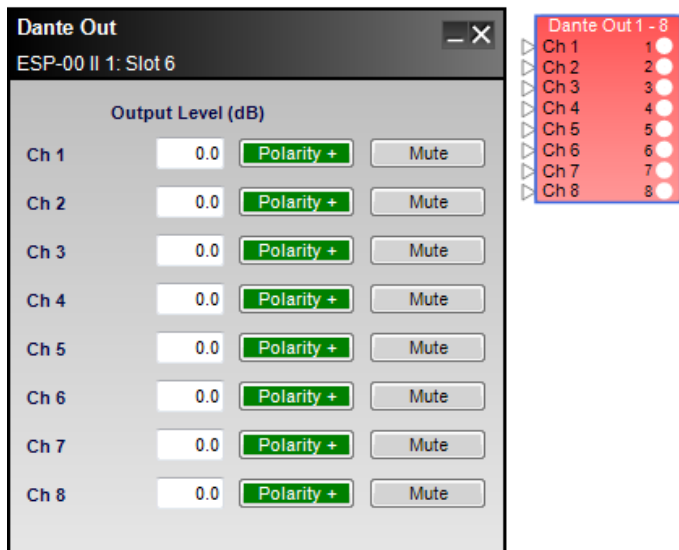

Example of eight-channel Dante network card output block and control panel

Each Dante output control panel provides the following controls:

Output Channel 1-n - Labels may be changed by highlighting the block in Signal Processing View, then using the Properties window.

Output Level (dB) - adjusts the output signal level delivered to the Dante digital output. The range of adjustment is from $-\infty$ to +12dB. Type a value directly into the output level box or right-click on the field to access a gain slider.

Polarity - applies a reversal of polarity to the output signal. When Polarity is normal, the control panel button is Green and a plus (+) sign is present. When Polarity is reversed, the control panel button is Red and a minus (-) sign is present.

Mute - silences the signal and disables audio from passing to the Dante digital output. When Mute is enabled, the control panel button is Red.

Page Down/Page Up - Only for blocks that have more than 8 channels. Use these controls to scroll forward or backward through the channels.

NOTE: For more information on configuring Bose professional system electronics for use with Dante digital audio network audio, refer to the Dante application notes available at pro.Bose.com.

ESP-00 II GPIO

The ESP-00 II has 8 General Purpose Input and Output (GPIO) ports which may be expanded to 16 GPI with the addition of a GPIO expansion card. GPI ports are used to connect external hardware such as potentiometers (to control levels or gains) and switches (contact closures) to invoke parameter sets and other logic and processing functions. Functions are assigned to these external controls in the GPI control panel.

See [Programming GPIO](#) for general programming examples.

GP In Control Panel

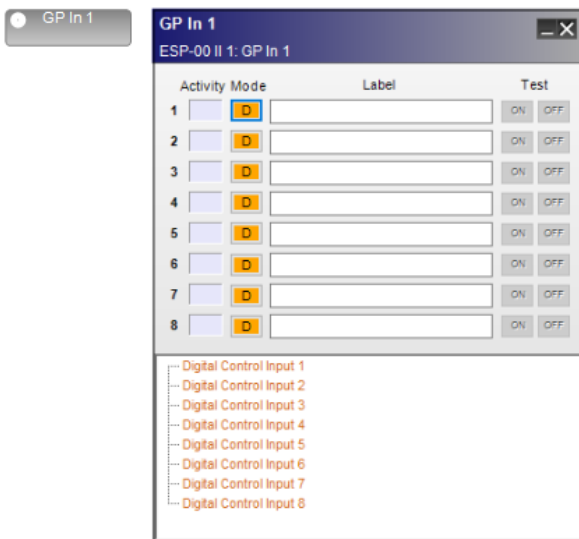

Adjustable input options are accessed by double clicking the appropriate **GP In** block within the **Signal Processing View** to open its control panel.



General Purpose Input (GP In) control panel



Activity - when online, indicators notify the user when a GP input senses activity on the hardware port. Blue indicates an active input/output, or when a **Test** button is pressed.

Mode buttons - Determine the operating mode for each general purpose input. Left click the operating mode button to toggle through the three supported modes:

Mode	Description
Digital 	Typically used when connecting a switch or push button, this mode expects a normally open switch for operation. Both “on” and “off” actions are supported
Up/Down 	Up/Down mode uses two adjacent GP In, and is intended to support two push buttons for use as volume up and down. Normally open switches are expected.
Analog 	<p>Analog mode is intended for a 10 KOhm linear type potentiometer that can be linked to a single or group of gain controls.</p> <p>Select A+ if the pot measures 0 ohms when fully <i>counter-clockwise</i> and 10K ohms when fully <i>clockwise</i>.</p> <p>Select A- if the pot measures 0 ohms when fully <i>clockwise</i> and 10K ohms when fully <i>counter-clockwise</i>.</p>

Label - Labels may be added to indicate the programming functionality to the user.

Test buttons - Permit verification of programmed actions for each input. Appearance and function of the test buttons change dynamically with each operating mode.

Mode	Test Operation
Digital 	Single left click per test button activates “on” or “off” conditions.
Up/Down 	Single left click per test button activates “up” or “down” conditions.
Analog 	<p>Analog mode is intended for a 10 KOhm linear type potentiometer that can be linked to a single or group of gain controls.</p> <p>Select A+ if the pot measures 0 ohms when fully <i>counter-clockwise</i> and 10K ohms when fully <i>clockwise</i>.</p> <p>Select A- if the pot measures 0 ohms when fully <i>clockwise</i> and 10K ohms when fully <i>counter-clockwise</i>.</p>

The lower section of the control panel provides a programming tree to assign functions invoked by the eight General Purpose Inputs. You can drag and drop signal processing blocks, parameter sets, or groups onto the text lines.

GP Out Control Panel

Output functions are accessed by double clicking the appropriate **GP Out** block within the **Signal Processing View** to open its control panel.

Label - Labels may be added to indicate the programming functionality to the user.

Buttons 1-8 - Correspond to the state of each individual general purpose output port. Click a button to set the state of an output to OFF (default) or ON before assigning the GP Out processing block in Signal Processing View to a location in the [Project Directory](#) or [Parameter Sets](#).

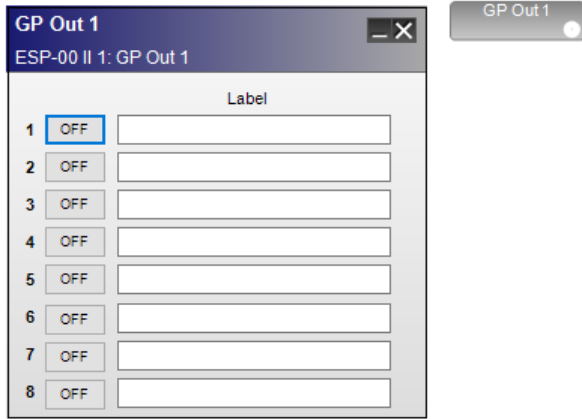

General Purpose Output (GP Out) control panel

ESP-00 II Serial Input/Outputs

Serial Command Support is provided for the ESP-00 II via the RS-232 serial port on the rear I/O panel of the ESP-00 II or via Ethernet connection. A Serial Protocol document is available to assist with programming 3rd party devices, see pro.Bose.com. Up to 64 serial input or output strings are supported. Double-click on the Serial Input or Serial Output blocks in Signal Processing View to open their control panels.

Serial Input

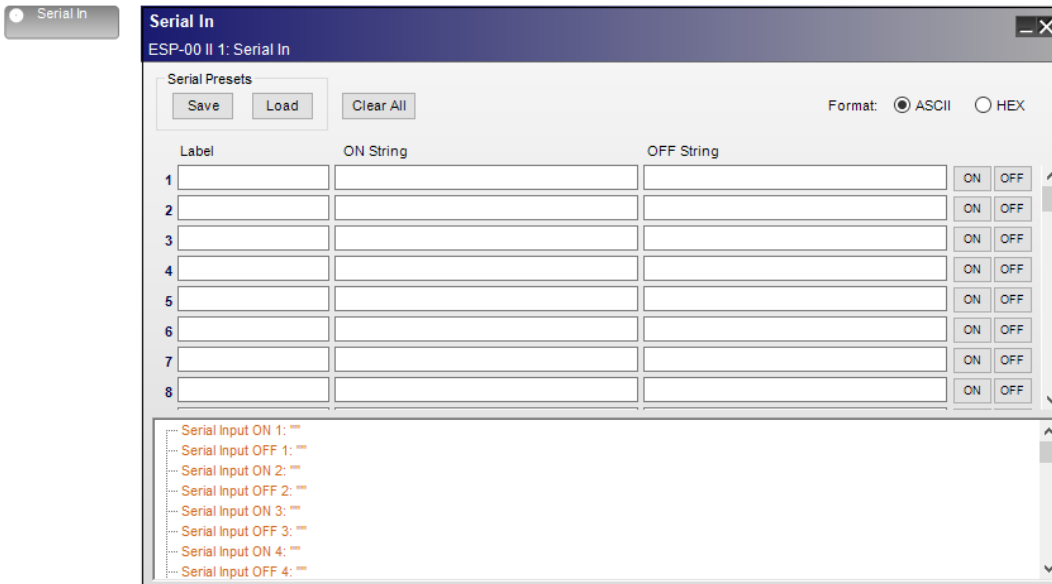

Serial Input processing block and control panel

The **Serial Input control panel** provides the following options:

Serial Presets - user can create presets of serial settings. The preset can then be exported as a serial preset file for future use, or used to build another serial preset file.

Save - exports the selected preset file to a user-specified location on a hard drive. The preset file has a .SPT file extension.

Load - uploads a user-selected preset file to the Serial In control panel.

Label - assigns a name to the serial string (see **String** entry). This is for reference only.

String – provides a location to store up to 64 ASCII characters or 64 HEX characters to match commands received from external devices via the RS-232 serial port or Ethernet port. Incoming serial strings are single momentary events rather than changes in state. Two separate serial input strings may be defined as an On/Off pair to help indicate associated control functions. Matching commands received within the serial data stream perform actions specified in the programming tree.

NOTE: To delete all of the Label and String entries from the control panel, select Clear All.

Format:

ASCII/HEX– radio buttons determine the unit notation for text entry. Select ASCII for traditional alphanumeric character entry or HEX to convert notation to two bytes per character.

ON/OFF - the ON and OFF buttons can be used to test the programming of the incoming strings.

Serial Input Programming Tree– provides a drag-and-drop area for assigning ESP-00 II functions to perform (block values or parameter sets) when matching serial strings arrive at the serial input.

NOTE: An ESP automatically assumes each input string terminates with one carriage return (CR). You must program the sending equipment to terminate the serial string with one CR at the end of each command. It is unnecessary to include this CR in the applicable fields of the Serial Input control panel.

Serial Output

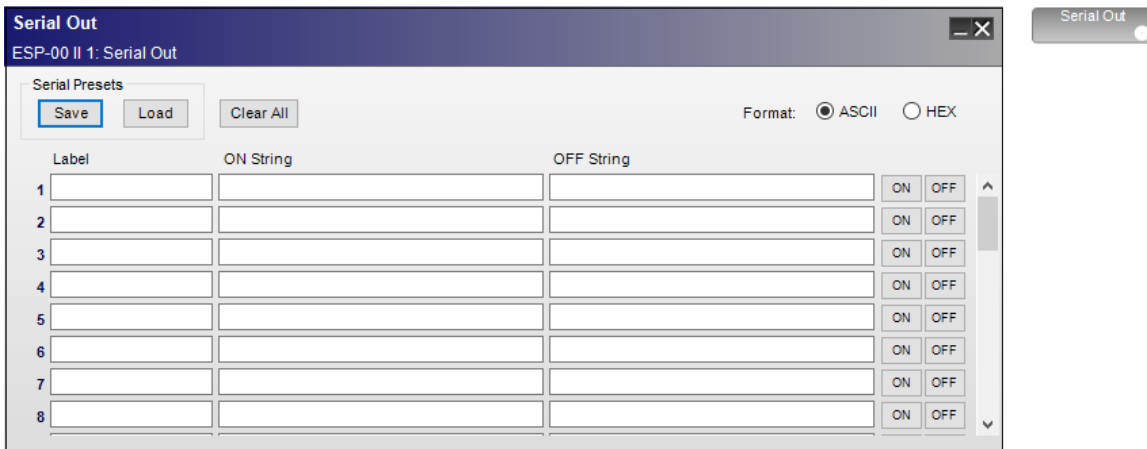

Serial output processing block and control panel

The **Serial Output control panel** provides the following options:

Serial Presets - user can create a preset of serial settings. The preset can then be exported as a serial preset file for future use, or used to build another serial preset file.

Save - exports the selected preset file to a user-specified location on a hard drive. The preset file has a .SPT file extension.

Load - uploads a user-selected preset file to the Serial Out control panel.

Label - assigns a name to the serial string (see **String** entry).

String - Outgoing serial strings are single momentary events rather than changes in state. Two separate serial output strings may be defined as an On/Off pair to help indicate associated control functions.

NOTE: To delete all of the Label and String entries from the control panel, select Clear All.

Format:

ASCII/HEX– radio buttons determine the unit notation for text entry. Select ASCII for traditional alphanumeric character entry or HEX to convert notation to two-bytes per character.

ON/OFF -tests the programming string for a specified ON or OFF logic state of a serial output, respectively. If no target is assigned to the serial string, the ON or OFF button is disabled. Serial output ON and OFF buttons are only active when online.

NOTE: When entering ASCII strings, control characters such as CR and LF must be entered in hexadecimal notation. Backslash 0 (\0) is used to designate the next two characters as hex. Control characters such as CR and LF are not automatically sent. These should be used based on the protocol of the third-party device.

ESP-880/1240/4120/1600 Processors

ESP-880/1240/4120/1600 Device Properties

Each of the fixed I/O ESP models is configured through the Properties panel. To access the ESP properties panel, right-click on the ESP-880/1240/4120/1600 icon in the Project View and select **Properties**.

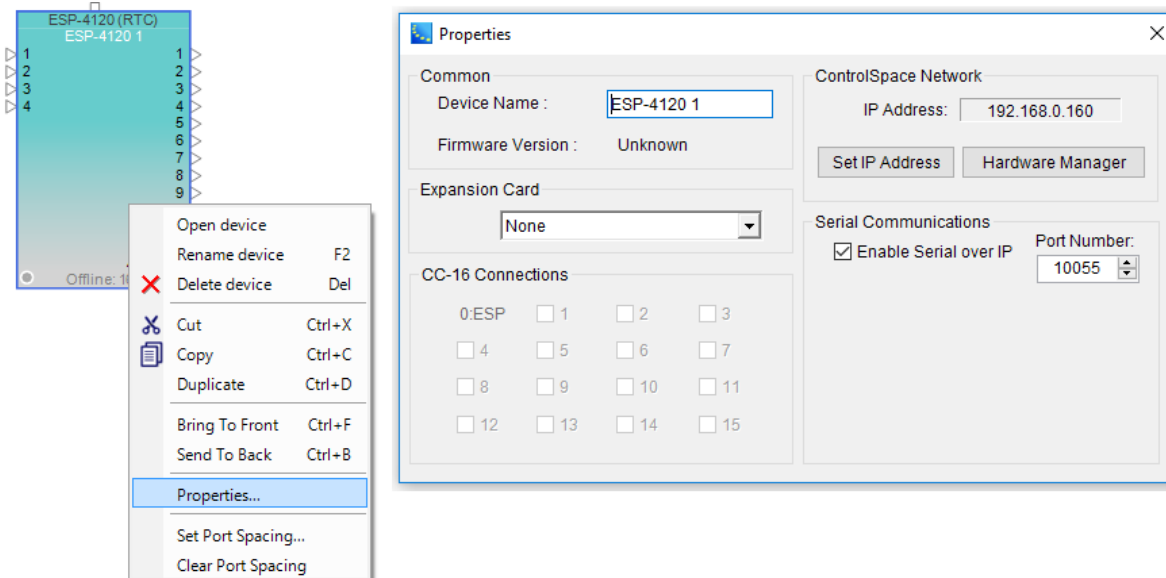

ESP-4120 Properties Panel

The Properties panel shows all of the items which determine the configuration of the ESP.

Common - Contains functions which are common to ESP 880/4120/1240/1600 devices:

Device Name – The unique name of the ESP that is displayed within the Project View. This unique name is also used in serial protocol programming. The name can be changed by selecting the name and entering a new one. The name may also be changed by using the right-click menu or the F2 keyboard shortcut.

Firmware Version – Displays the current version of the firmware in the ESP. This item is only available when on-line with the ESP.

Expansion Card - This field allows the user to select between available expansion cards: ControlSpace Network, Dante 16 (16x16 configuration), or Dante 32 (32x32 configuration). Selecting expansion cards must be done while offline.

CC-16 Connection – Displays a check mark beside numbers 1 through 15 matching the device ID of each CC-16 connected to the ESP.

ControlSpace Network– Displays the current IP address for the ControlSpace Network port. When configured for DHCP, the device address is disabled. When configured for Fixed IP, the device address is enabled. To change the network connection type, the Network Setup control panel must be used.

Set IP Address – Clicking this button allows you to change the IP address of the device.

Hardware Manager – Clicking this button opens the Hardware Manager dialog. See [Launching the Hardware Manager](#).

Serial Communications - Provides serial data settings.

Enable Serial over IP - Check the box to enable serial communication over IP.

Port Number - Current serial communications port number.

ESP-880/1240/4120/1600 Input Controls

Adjustable input controls are accessed by double clicking on an analog input block within **Signal Processing View** to open the control panel.

Each input control panel displays the controls for four analog input channels: either 1-4 or 5-8.

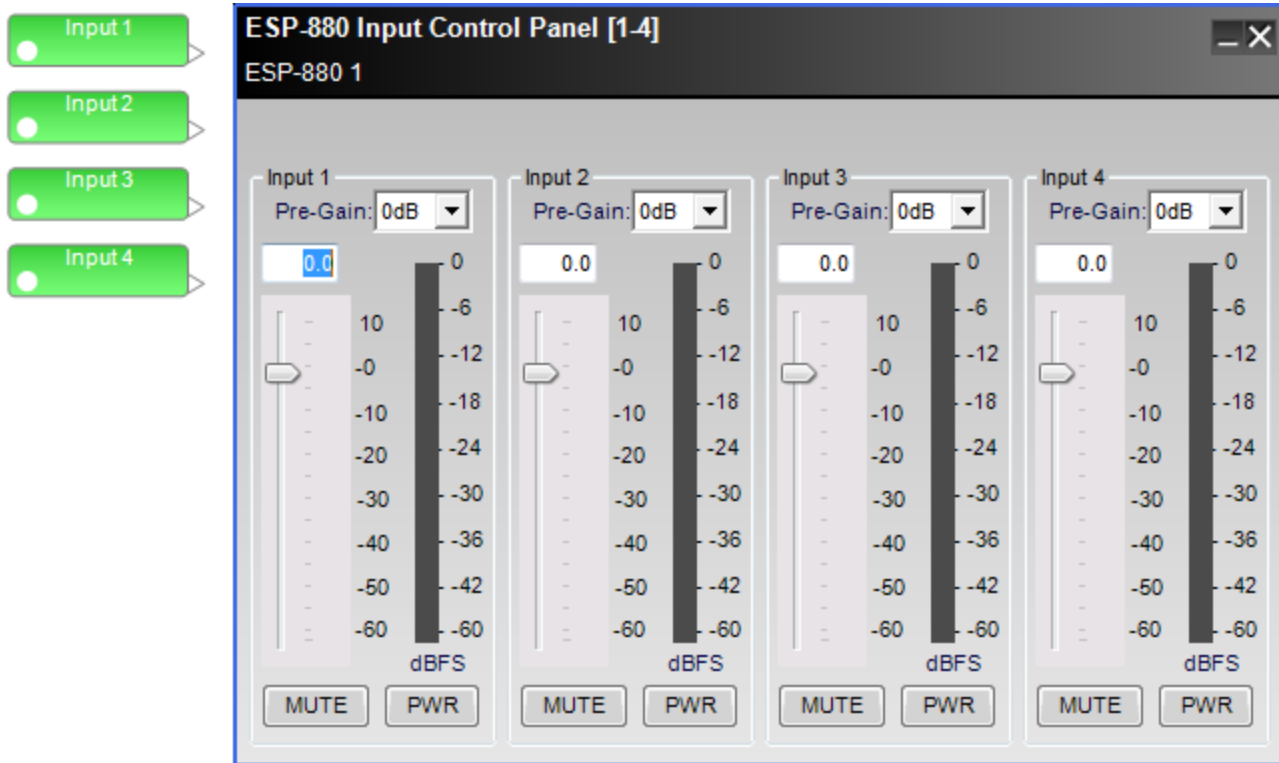

ESP-880 input control panel

The **Input Control Panel** provides the following options

Input 1-4 Label - Displays the channel name as defined by the user within the Signal Processing View of the ESP. Labels may be changed by highlighting the input block in the Signal Processing View, then using the F2 key, right click menu, or the Properties window.

Pre-Gain Control - Allows the selection of a pre-defined amount of analog input gain (0, 14, 24, 32, 44, 54, or 64 dB).

Input Level Entry - Permits direct entry of desired input signal level in dB. Range of adjustment matches and tracks the input gain slider.

Input Gain Slider - Adjusts the input signal level delivered to the next signal processing block. The range of adjustment is from $-\infty$ to +12dB. This adjustment point is in the digital domain, post analog to digital conversion.

Input Signal Meter - Displays the current input signal level in dBFS at the input to the next processor function. Input meters include a 'peak hold' indicator which is identified by a red line across the meter.

Mute - Silences the signal and disables audio from passing to the next signal processing block in the design. When Mute is enabled, the control panel button is Red.

PWR - When selected, engages the +48V phantom power.

ESP-880/1240/4120/1600 Output Controls

Adjustable output controls are accessed by double clicking on an output block within **Signal Processing View** to open the control panel.

Each output control panel displays the controls for four analog output channels: 1-4 or 5-8.

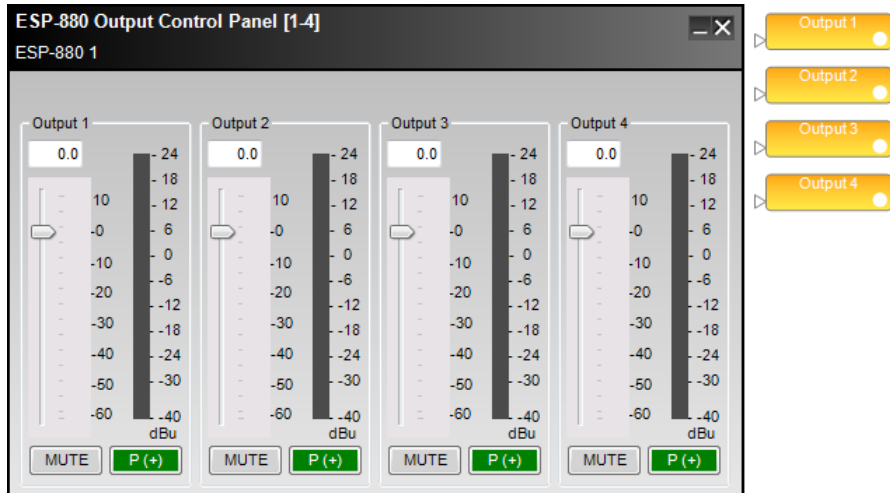

ESP-880 output control panel

The **Output Control Panel** provides the following options:

Output 1-4 Label - Displays the channel name as defined by the user within the Signal Processing View. Labels may be changed by highlighting the input block in Signal Processing View, then using the F2 key, right-click menu, or the Properties window.

Output Level Entry - Allows the direct entry of the amount of attenuation ($-\infty$ dB, min, to +12 dB, max, in increments of 0.5 dB) applied to the output signal.

Output Gain Slider - Adjusts the output signal level delivered to the next analog output. The range of adjustment is from $-\infty$ to +12dB.

Output Signal Meter - Displays the current output signal level in dBFS at the input to the next processor function. Output meters include a 'peak hold' indicator which is identified by a red line across the meter.

Mute - Silences the signal and disables audio from passing to the next analog output. When **Mute** is enabled, the control panel button is Red.

Signal Polarity Control - Inverts the polarity of the signal. Default value is positive (+) or non-inverted. When selected, the signal polarity is negative (-) or inverted. Button color is used to indicate current state with GREEN being non-inverted and RED being inverted.

ESP-880/1240/4120/1600 ESPLink Output Controls

Adjustable options may be changed in the control panel for the ESPLink outputs. The control panel can be opened by double clicking on the ESPLink output block in Signal Processing View. This control panel displays all eight output channels.

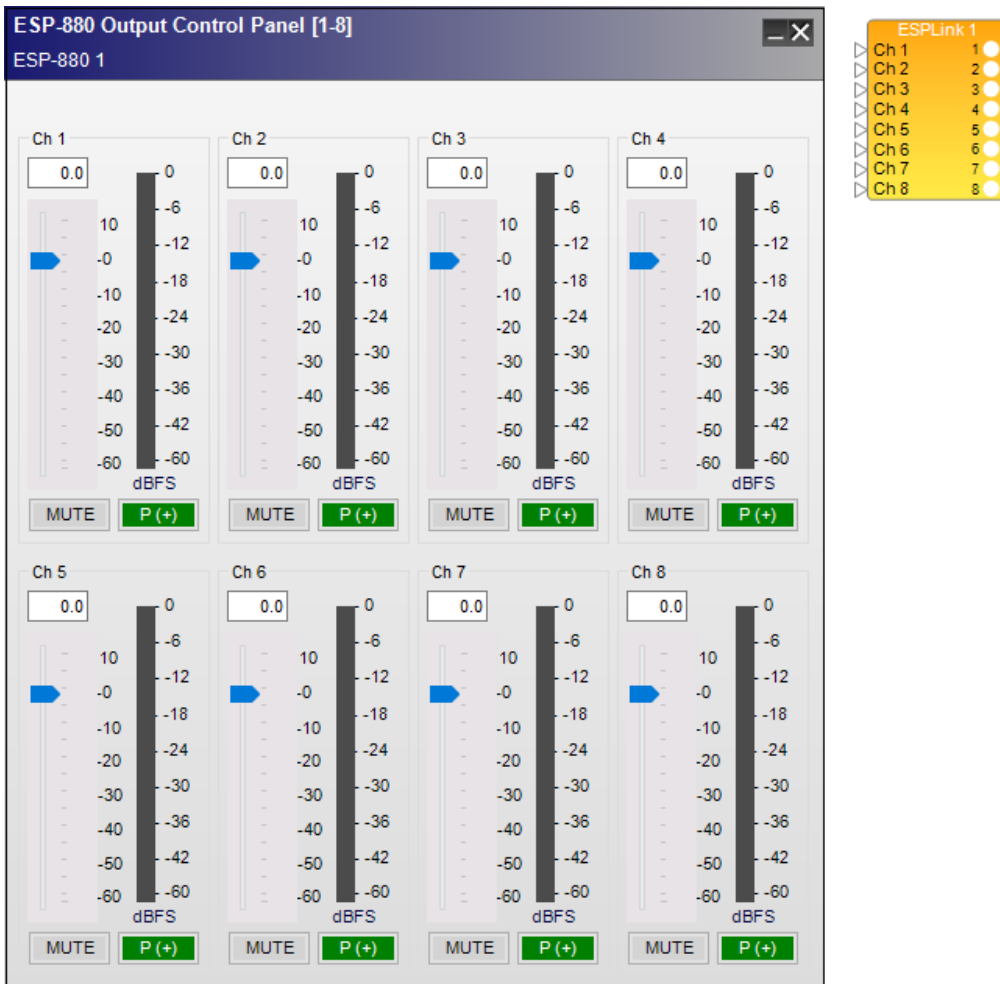

ESP-880 ESPLink output control panel

The **Output Control Panel** provides the following options:

Output Label - displays the channel name.

Digital Output Level Direct Entry - allows the direct entry of the amount of attenuation ($-\infty$ dB, min, to +12 dB, max, in increments of 0.5 dB) applied to the output signal.

Digital Output Gain Slider - allows the adjusting of the amount of attenuation ($-\infty$ dB, min, to +12 dB, max, in increments of 0.5 dB) applied to the output signal.

Output Signal Meter - displays the current output signal level in dBFS at the output of the signal processor. Output meters include a peak hold indicator, which is identified by a red line across the meter.

Mute - when selected, mutes the audio signal at the digital output stage.

Signal Polarity Control - inverts the polarity of the signal. Default value is positive (+) or non-inverted. When selected, the signal polarity is negative (-) or inverted. Button color is used to indicate current state with GREEN = non-inverted and RED = inverted.

ESP-880/1240/4120/1600 GPIO

Fixed-I/O ESPs have 5 General Purpose Control Input (GP In) ports and 5 GP Control Output (GP Out) ports. GP In ports are used to connect external hardware such as potentiometers (to control levels or gains) and switches (contact closures) to invoke parameter sets and other logic and processing functions. Functions are assigned to these external controls in the **GP In** control panel.

See [Programming GPIO](#) for general programming examples.

GP In Control Panel

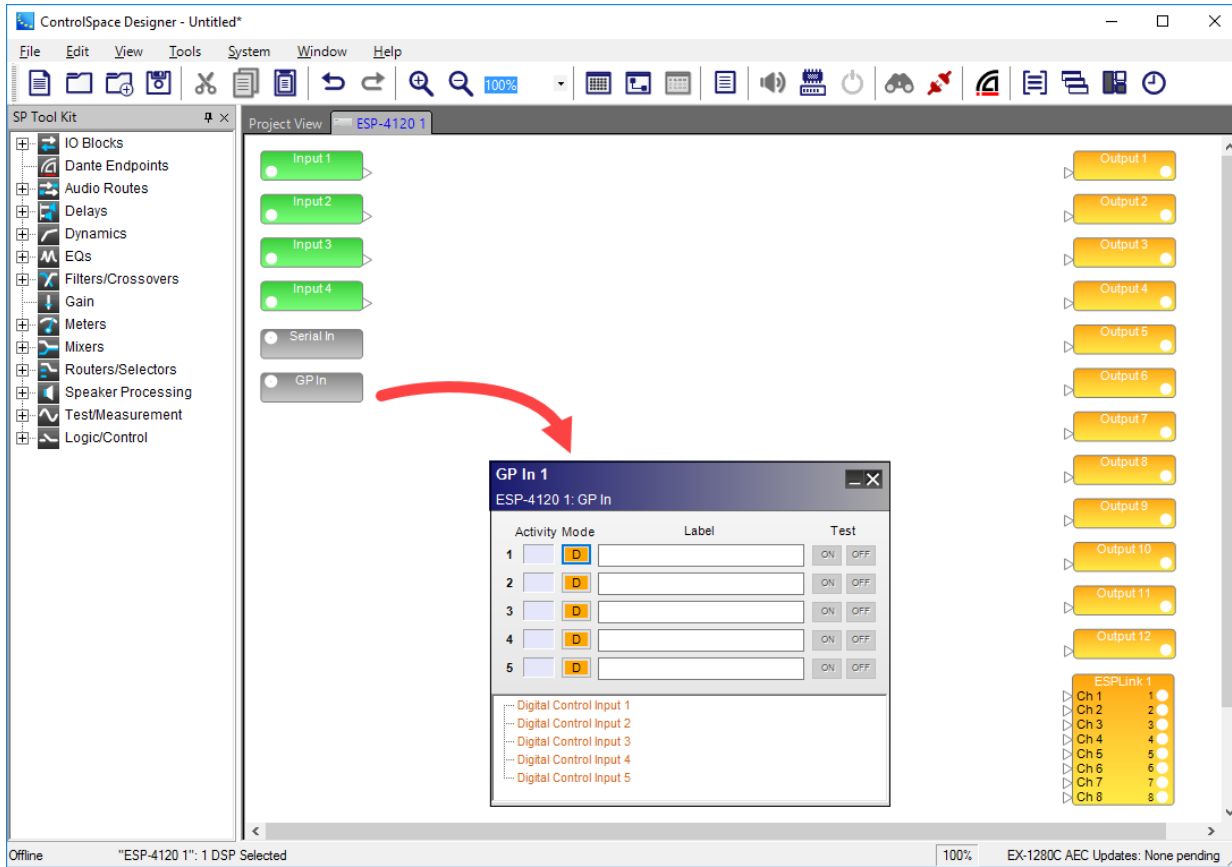

Adjustable input options are accessed by double clicking the appropriate **GP In** block within **Signal Processing View** to open its control panel.



General Purpose Input (GP In) control panel



Activity - when online, indicators notify the user when a GP input senses activity on the hardware port. Blue indicates an active input/output, or when a **Test** button is pressed.

Mode buttons– Determine the operating mode for each general purpose input. Left click the operating mode button to toggle through the three supported modes:

Mode	Description
Digital 	Typically used when connecting a switch or push button, this mode expects a normally open switch for operation. Both “on” and “off” actions are supported.
Up/Down 	Up/Down mode uses two adjacent GPI, and is intended to support two push buttons for use as volume up and down. Normally open switches are expected.
Analog 	<p>Analog mode is intended for a 10 KOhm linear type potentiometer that can be linked to a single or group of gain controls.</p> <p>Select A+ if the pot measures 0 ohms when fully <i>counter-clockwise</i> and 10K ohms when fully <i>clockwise</i>.</p> <p>Select A- if the pot measures 0 ohms when fully <i>clockwise</i> and 10K ohms when fully <i>counter-clockwise</i>.</p>

Label - Labels may be added to indicate the programming functionality to the user.

Testbuttons - Permit verification of programmed actions for each input. Appearance and function of the test buttons changedynamically with each operating mode.

Mode	Test Operation
Digital 	Single left click per test button activates “on” or “off” conditions.
Up/Down 	Single left click per test button activates “up” or “down” conditions.
Analog 	<p>Analog mode is intended for a 10 KOhm linear type potentiometer that can be linked to a single or group of gain controls.</p> <p>Select A+ if the pot measures 0 ohms when fully <i>counter-clockwise</i> and 10K ohms when fully <i>clockwise</i>.</p> <p>Select A- if the pot measures 0 ohms when fully <i>clockwise</i> and 10K ohms when fully <i>counter-clockwise</i>.</p>

The lower sectionof the control panel provides a programming tree to assign functions invoked by the General Purpose Inputs. You can drag and drop signal processing blocks, parameter sets, or groups onto the text lines.

GP Out Control Panel

Output functions are accessed by double clicking the appropriate **GP Out** block within the **Signal Processing View** to open its control panel.

Buttons 1-5 - Correspond to the state of each individual general purpose output port. Click a button to set the state of an output to OFF (default) or ON before assigning the GP Out processing block in Signal Processing View to a location in the **Project Directory** or **Parameter Sets**.

Label - Labels may be added to indicate the programming functionality to the user.

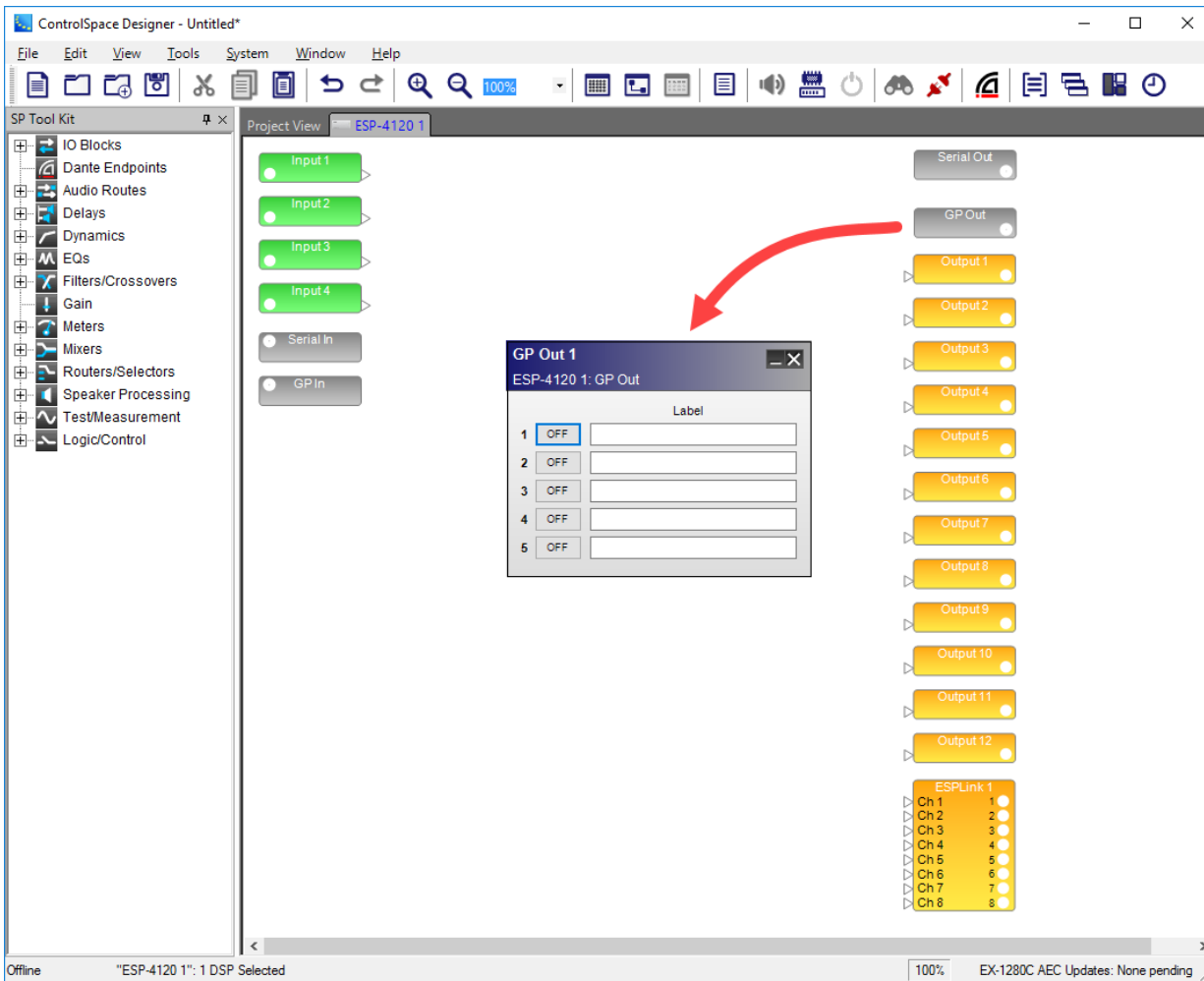

General Purpose Output (GP Out) control panel

ESP-880/1240/4120/1600 Serial Input/Outputs

Serial Command Support is provided for the ESP-880/1240/4120/1600 via the integral serial port on the rear I/O panel of the ESP or via Ethernet connection. A Serial Protocol document is available to assist with programming 3rd party devices, see pro.Bose.com. Up to 64 serial input or output strings are supported. Double-click on the Serial Input or Serial Output blocks in Signal Processing View to open their control panels.

Serial Input Control Panel

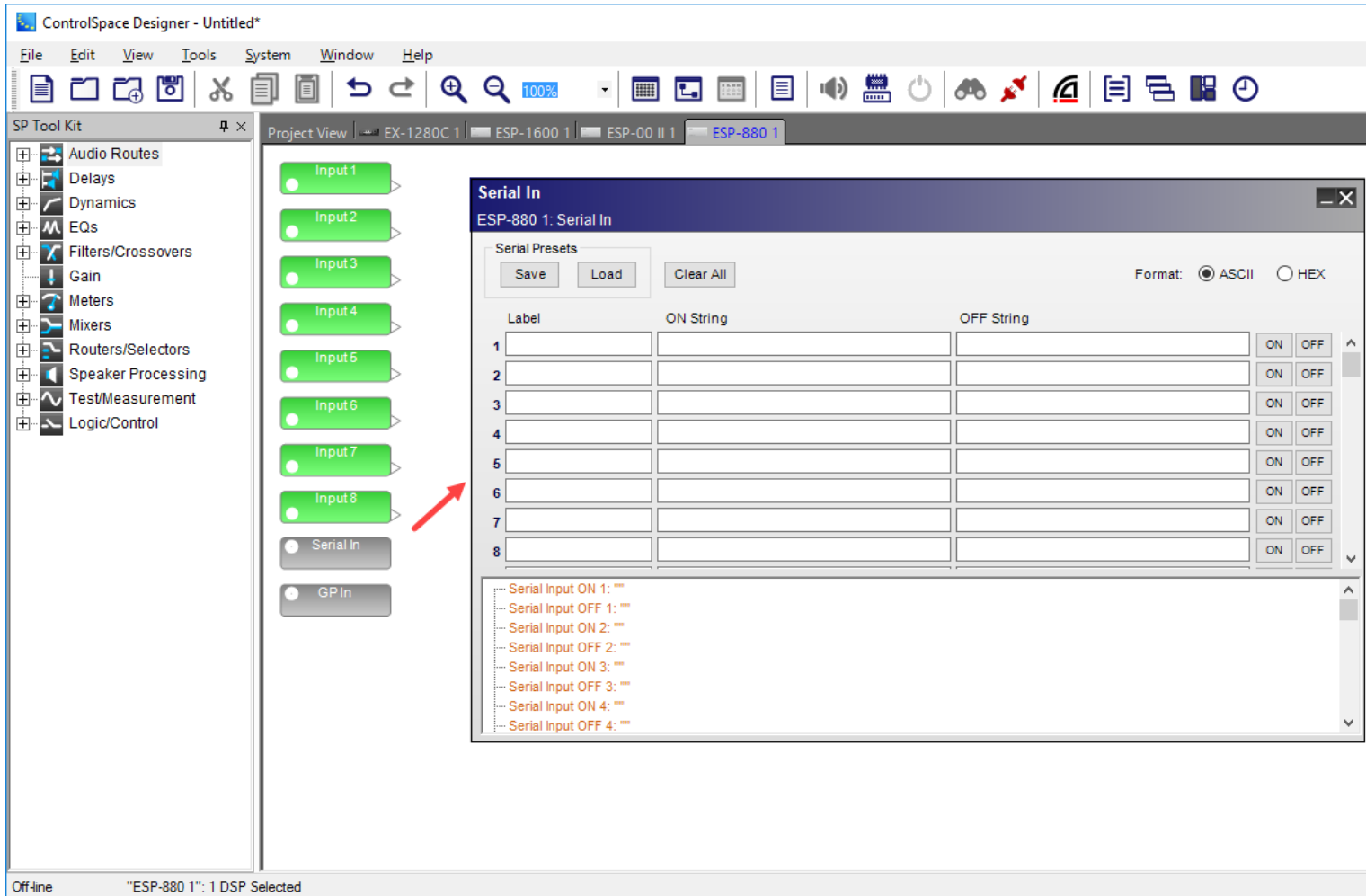

Serial Input processing block and control

The **Serial Input control panel** provides the following options:

Serial Presets - user can create presets of serial settings. The preset can then be exported as a serial preset file for future use, or used to build another serial preset file.

Save - exports the selected preset file to a user-specified location on a hard drive. The preset file has a .SPT file extension.

Load - uploads a user-selected preset file to the Serial In control panel.

Label - assigns a name to the serial string (see **String** entry). This is for reference only.

String - provides a location to store up to 64 ASCII characters or 64 HEX characters to match commands received from external devices via the RS-232 serial port or Ethernet port. Incoming serial strings are single momentary events rather than changes in state. Two separate serial input strings may be defined as an On/Off pair to help indicate associated control functions. Matching commands received within the serial data stream perform actions specified in the programming tree.

NOTE: To delete all of the Label and String entries from the control panel, select **Clear All**.

Format:

ASCII/HEX- radio buttons determine the unit notation for text entry. Select ASCII for traditional alphanumeric character entry or HEX to convert notation to two bytes per character.

ON/OFF -the ON and OFF buttons can be used to test the programming of the incoming strings.

Serial Input Programming Tree– provides a drag-and-drop area for assigning ESP 880/1240/4120/1600 functions to perform (block values or parameter sets) when matching serial strings arrive at the serial input.

NOTE: An ESP automatically assumes each input string terminates with one carriage return (CR). You must program the sending equipment to terminate the serial string with one CR at the end of each command. It is unnecessary to include this CR in the applicable fields of the Serial Input control panel.

Serial Output Control Panel

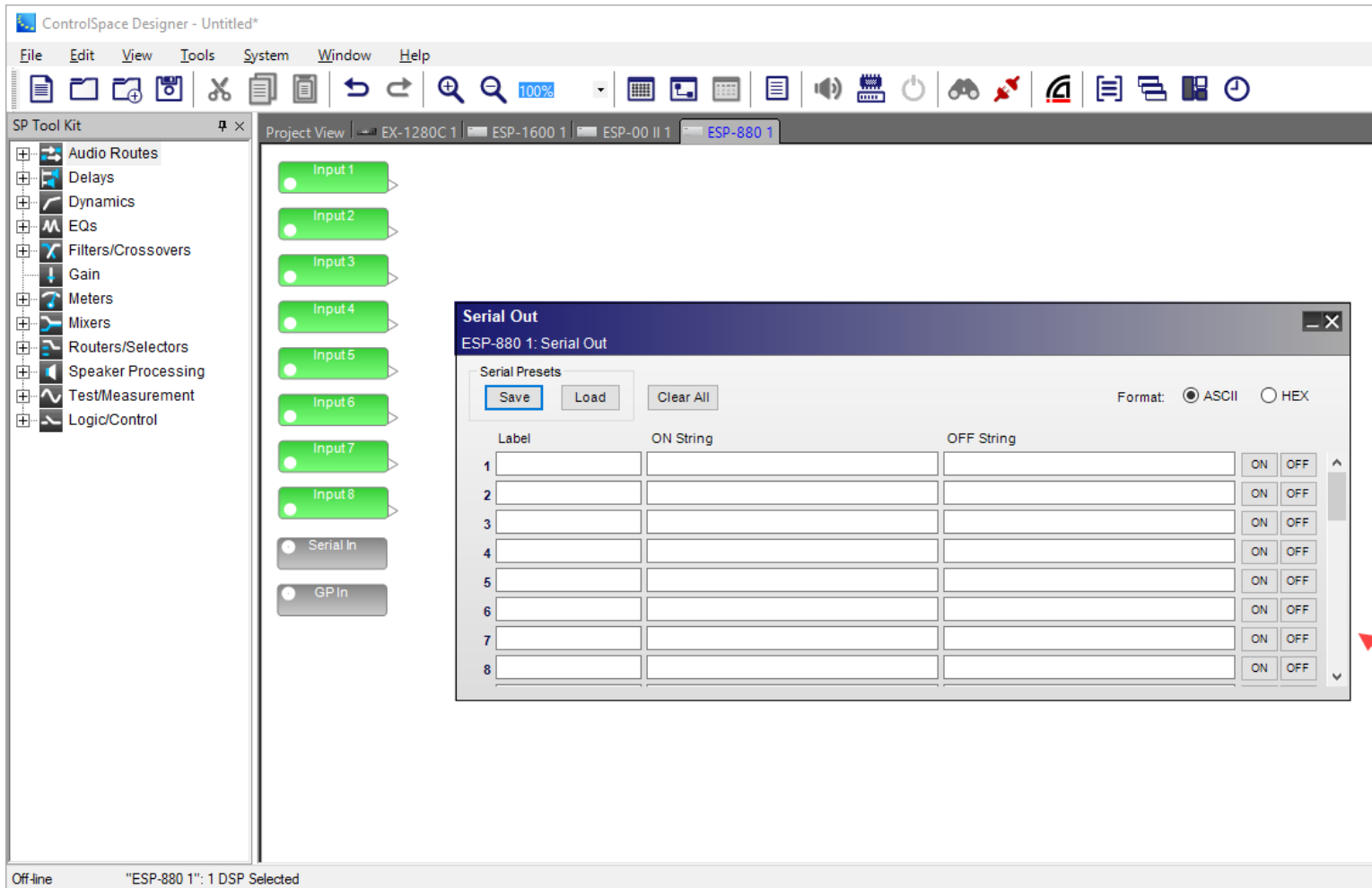

Serial output processing block and control panel

The **Serial Output control panel** provides the following options:

Serial Presets - user can create a preset of serial settings. These can then be exported as a serial preset file for future use, or used to build another serial preset file.

Save - exports the selected preset file to a user-specified location on a hard drive. The preset file has a .SPT file extension.

Load - uploads a user-selected preset file to the Serial Out control panel.

Label – assigns a name to the serial string (see **String** entry).

String – provides a location to store up to 64 ASCII characters or 64 HEX characters to be sent to external devices via the RS-232 serial port or the Ethernet port. Outgoing serial strings are single momentary events rather than changes in state. Two separate serial output strings may be defined as an On/Off pair to help indicate associated control functions. Transmission of strings can be initiated via Parameter Sets, GPI ports, and other logic events.

NOTE: To delete all of the Label and String entries from the control panel, select Clear All.

Format:

ASCII/HEX- radio buttons determine the unit notation for text entry. Select ASCII for traditional alphanumeric character entry or HEX to convert notation to two-bytes per character.

ON/OFF -tests the programming string for a specified ON or OFF logic state of a serial output, respectively. If no target is assigned to the serial string, the ON or OFF button is disabled. Serial output ON and OFF buttons are only active when online.

NOTE: When entering ASCII strings, control characters such as CR and LF must be entered in hexadecimal notation. Backslash O (\O) is used to designate the next two characters as hex. Control characters such as CR and LF are not automatically sent. These should be used based on the protocol of the third-party device.

Expansion Cards

Dante™ Network Card

The Bose ESP-880/1240/4120/1600 engineered sound processors are capable of supporting up to 32 channels of high quality, uncompressed digital audio from a Dante digital audio network in a 16x16 or 32x32 configuration. You can also configure Dante I/O for less than the maximum number of channels available in each configuration.

For more information on Dante networks and the Dante global properties control panel, see [Dante™ Network Device Properties](#).

Defining the Dante™ Card Configuration

The Dante digital audio network card is added to the ESP-880/1240/4120/1600 in the same manner as other expansion cards. If the card has already been fitted, it will be detected automatically when a hardware scan is performed. Otherwise, the card can be added manually to the system design as follows:

Right-click on the ESP-880/1240/4120/1600 icon in Project View and select **Properties** to display the ESP-880/1240/4120/1600 Properties window. Then, select the appropriate Dante card option from within the Expansion Card drop-down list.

NOTE: When the front RJ-45 jack only provides access to the ControlSpace network, Dante is not available on the front Ethernet port.

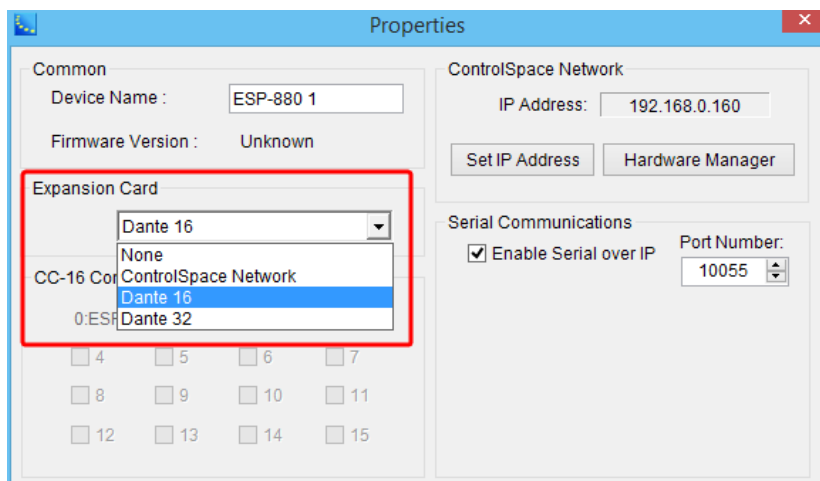

Dante Digital Audio network card option within ESP-880/1240/4120/1600 properties

Setting the Number of Channels

To set the number of channels for a Dante input or output block:

- From the IO Blocks category in the SP Tool Kit, drag the Dante I/O input or output processing block into Signal Processing View.

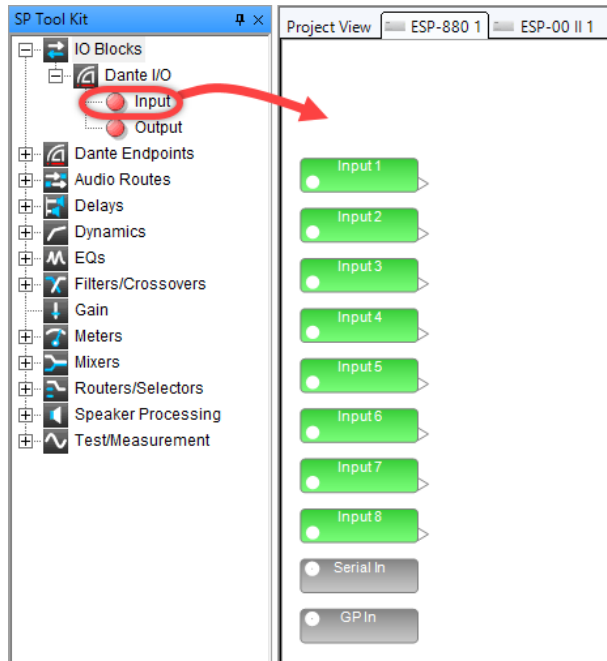

Example of dragging Dante I/O Input block to SP view

- In the Select Channels dialog, use Ctrl-Click to select each channel to be included in the block or click and drag to select contiguous channels. You can also check or clear the **Select All** option to select/deselect all of the channels available in the card. The channel counter displays the number of channels selected (you may not use the counter to change or select channels, however).

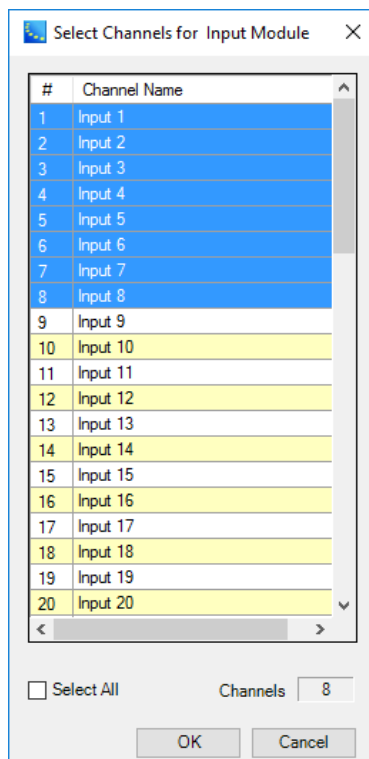

Select Channels dialog

- Click **OK**.

The Dante input or output processing block is now added to the view.

Dante Network Card Input/Output Control

The Dante digital audio network cards offer a basic set of input and output controls, which can be accessed by double-clicking on the Dante input or output processing block in Signal Processing View.

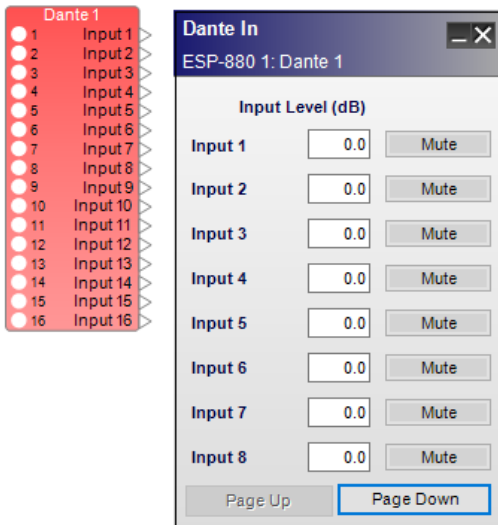

Example of 16-channel Dante network card input block and control panel

Each Dante input control panel provides the following controls:

Input Channel 1-*n* - Labels may be changed by highlighting the input block in the Signal Processing View, then using the Properties window to make the change.

Input Level (dB) - adjusts the input signal level delivered to the next signal processing block. The range of adjustment is from $-\infty$ to +12dB. This adjustment point is in the digital domain. Type a value directly into the input level box or right-click on the field to access a gain slider.

Mute - silences the signal and disables audio from passing to the next signal processing block in the design. When Mute is enabled, the control panel button is Red.

Page Down/Page Up - Only for blocks that have more than 8 channels. Use these controls to scroll forward or backward through the channels.

The output controls of the Dante card are accessed by double clicking on the appropriate Dante output block within the Signal Processing View.

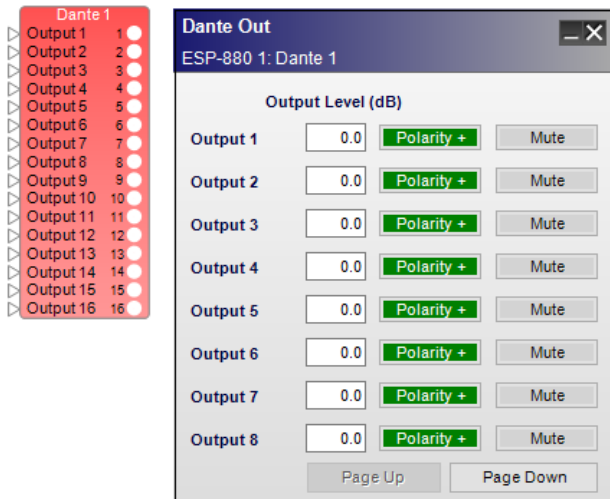

16 channel Dante network card output block and control panel

Each Dante output control panel provides the following controls:

Output Channel 1-*n* - Labels may be changed by highlighting the input block in the Signal Processing View, then using the Properties window to make the change.

Output Level (dB) - adjusts the output signal level delivered to the Dante digital output. The range of adjustment is from $-\infty$ to +12dB. Type a value directly into the output level box or right-click on the field to access a gain slider.

Polarity - applies a reversal of polarity to the output signal. When Polarity is normal, the control panel button is Green and a plus (+) sign is present. When Polarity is reversed, the control panel button is Red and a minus (-) sign is present.

Mute - silences the signal and disables audio from passing to the Dante digital output. When Mute is enabled, the control panel button is Red.

Page Down/Page Up - Only for blocks that have more than 8 channels. Use these controls to scroll forward or backward through the channels.

NOTE: For more information on configuring Bose professional system electronics for use with Dante digital audio network audio, refer to the Dante application notes available at pro.Bose.com.

ControlSpace® Network Control Card

The ControlSpace® Network Control Card adds a rear panel network connection to single-rack ControlSpace ESP processors. With this card, a network connection can be made on the rear panel but it also allows network pass-through from the front-panel RJ-45 port.

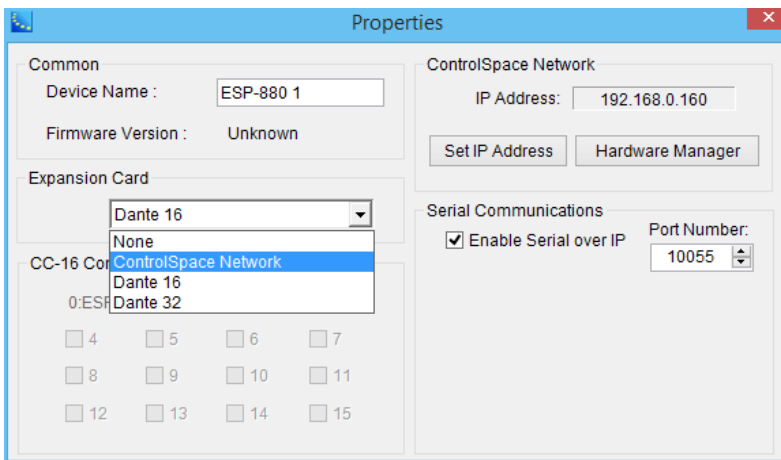

ESP Signal Processing

SP Tool Kit

The **Signal Processing (SP) Tool Kit** contains all the signal processing blocks available for use in system designs. The **SP Tool Kit** panel is visible when you are working in Signal Processing View. To add signal processing functions, use the mouse to drag a block from the SP Tool Kit panel and drop it into the applicable Device tab in Signal Processing View.

Signal processing blocks in the SP Tool Kit are categorized by type. Click the "+" next to a group in the SP Tool Kit to expand the group and view its signal processing blocks. To open the control panel for any signal processing block, double-click on the block after you have added it to the applicable Device tab in Signal Processing View.

ESP Signal Processing View

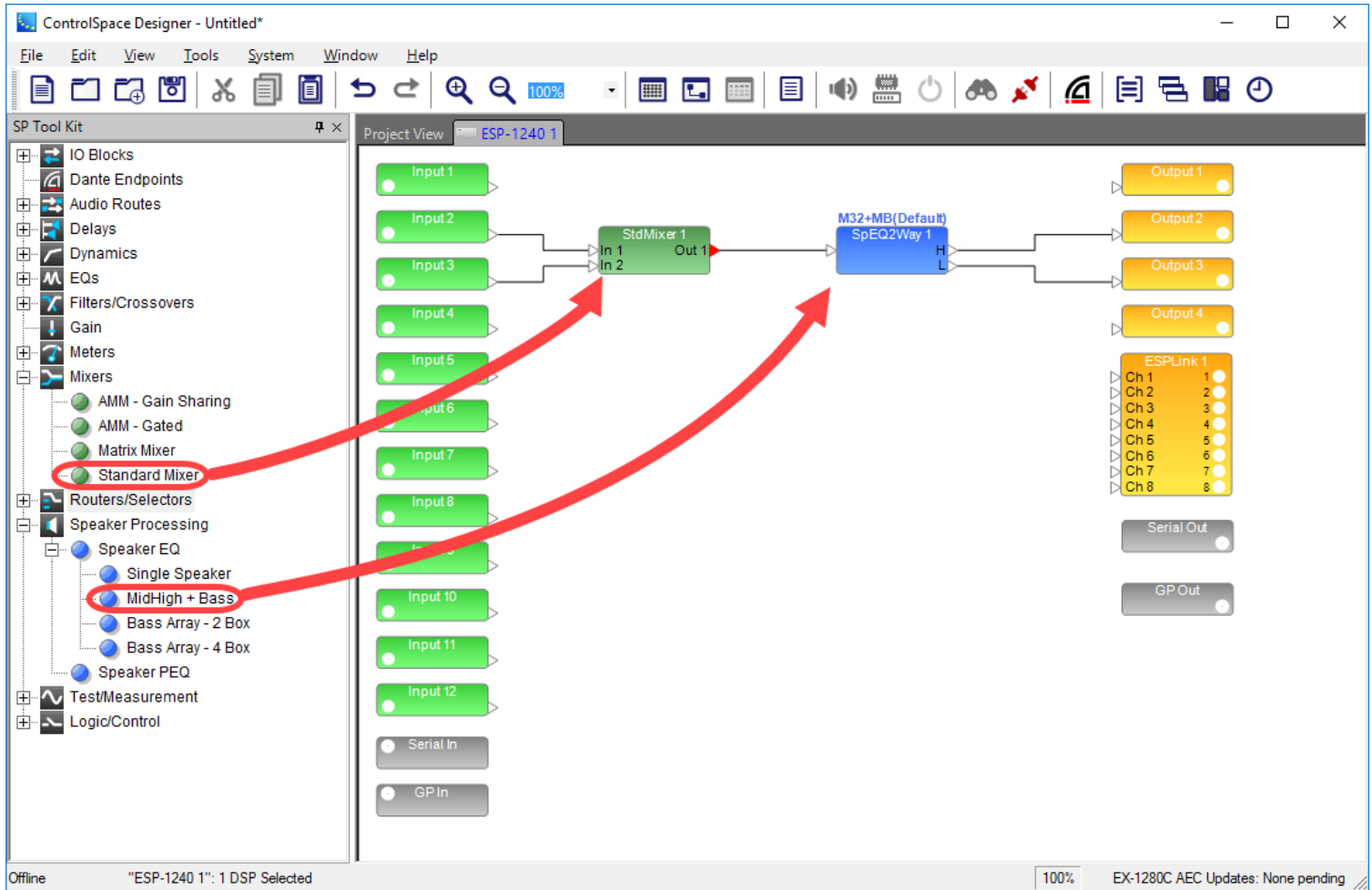

Adding signal processing block to ESP Signal Processing View from SP Tool Kit

EX-1280C Signal Processing View

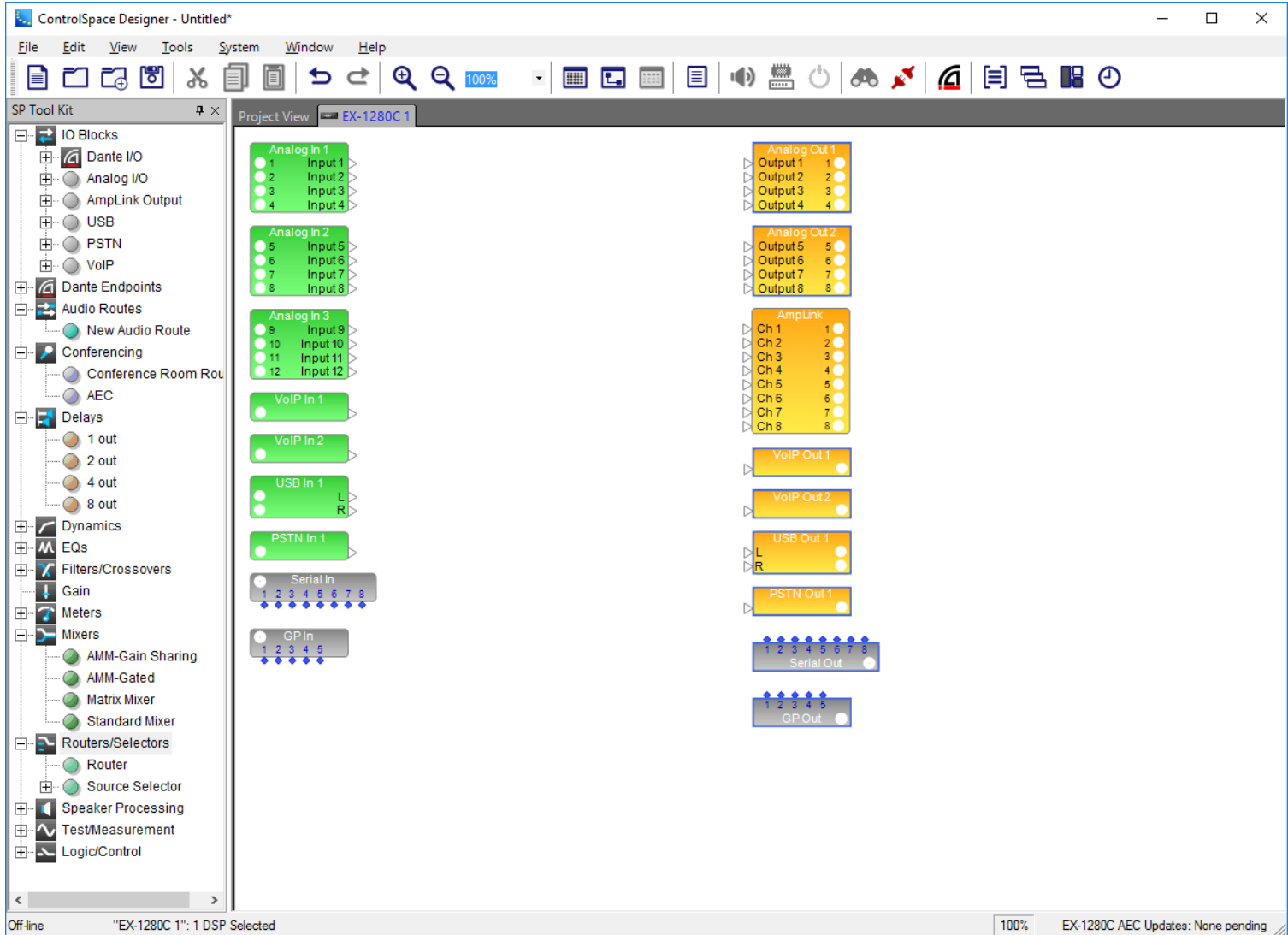

SP Tool Kit for EX-1280C Signal Processing View

Working With SP Blocks

After dropping signal processing blocks into Signal Processing View, you can move one or more blocks by selecting and dragging with the mouse, or by using the arrow keys on your keyboard to nudge the blocks into position. Multiple blocks or items may be selected by using the mouse to drag a selection box around the target items.

Aligning Blocks

To align blocks, use the options in the **Edit menu**. For example, to vertically align the left borders of a group of blocks, select all the blocks and choose **Edit > Align Left Sides**.

NOTE: See the [Edit Menu](#) for additional alignment options.

Wiring Blocks

The output ports of signal processing blocks may be wired to multiple inputs on other devices. Conversely, each input port on a signal processing block may only be connected to one output port on another

processing block.

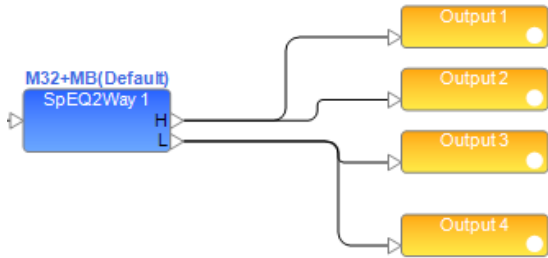

Wiring signal processing blocks

Other SP Block and Wiring Operations

For more information on SP block wiring operations, see [Wiring Operations](#).

For more information on SP block-handling functions, see [Block-Handling Functions](#).

Changing Channel Counts on Blocks

The audio channel count on many SP blocks may be modified after they have been added to a device in the Signal Processing View. This option is only available when the device is offline. In the right-click menu, select **Change Channel Count** to change the audio channel count.

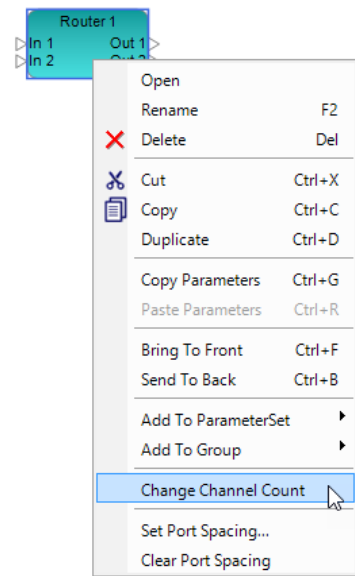

If a block's channel count is modified, the block will be removed from any programming (parameter sets, groups, and timers). If an affected block is in programming when you attempt to re-size it, you will be warned before completing the action. From here, you may click **OK** to continue with modification of the block, or back out of it by clicking **Cancel**.

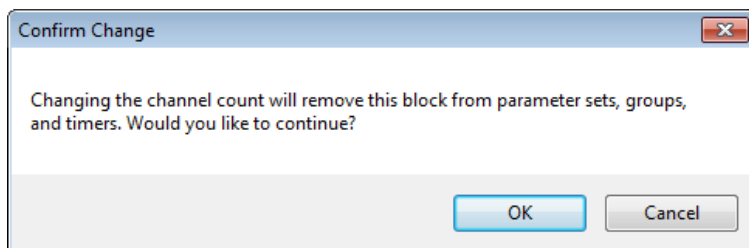

Changing Mixer Channel Input and Output Labels

Input and output channels in Standard Mixers and Matrix Mixers can be given custom labels. These can be edited by double-clicking the block and using the mixer's control panel. The labels are located at the left (input) and top (output) of the form.

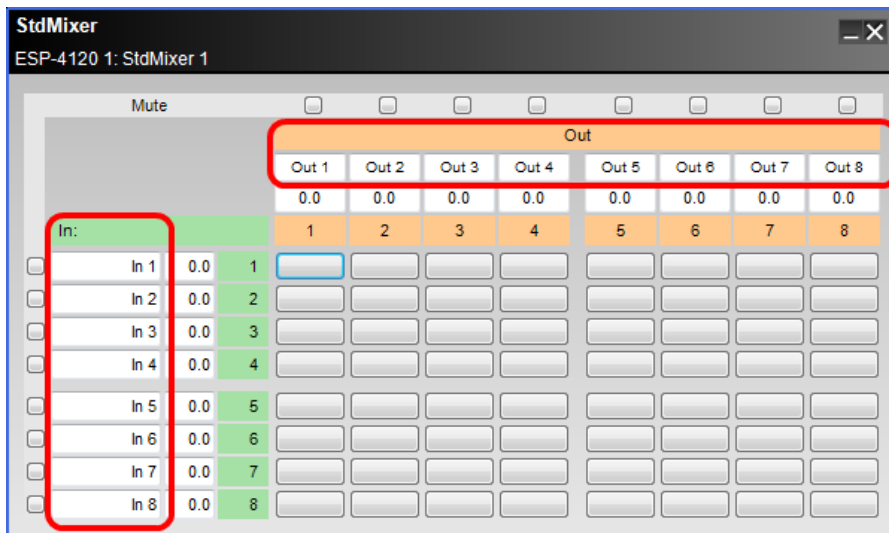

Supported Signal Processing Algorithms for ESP

AGC

Automatic Gain Control (AGC) combines a compressor and a gate to maintain a constant output signal level with varying input signal levels. Both a monaural AGC with one input and a stereo AGC with two inputs are supported.

Control panels for mono and stereo versions are similar. The stereo AGC adds a Detector drop down list.

Double-click on the AGC block in Signal Processing View to open its control panel.

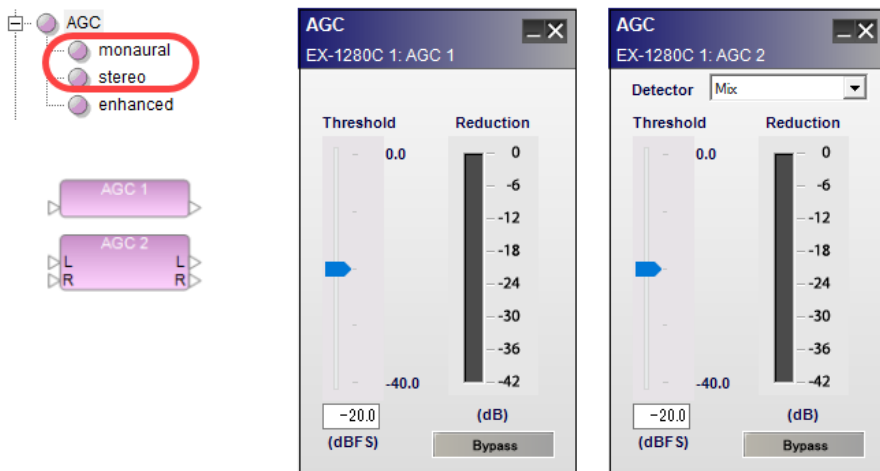

AGC processing blocks and control panels

The AGC control panel provides the following options:

Detector – (stereo only) determines which of the available signal inputs are monitored to trigger the signal processing.

Left - indicates the left signal is the trigger for processing.

Right - indicates the right signal is the trigger for processing.

Mix - indicates a left/right mix signal is the trigger for processing.

Threshold slider – determines when the processing block will begin adjusting the input signal according to its level. When the signal drops below this threshold, the input is prevented from passing through the processing block.

Threshold gain value – is entered directly into the box. The range of adjustment is -40 to 0 dBFS (default) and tracks the threshold slider setting.

Reduction graph – displays a vertical bar level indicator to illustrate the amount of signal reduction applied based upon the currently defined processing values.

Bypass – forces the channel to remain open at all times by circumventing the detection circuitry.

Array EQ

The Array EQ signal processing function provides specialized equalization for RoomMatch[®] array module loudspeakers. This unique EQ processor may be used as a general purpose room compensation EQ for standard systems.

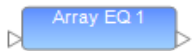

To access the Array EQ control panel, double click on its signal processing block in the Signal Processing View. The default state of the Array EQ is Bypass, to provide a flat initial response.

The following controls are available within the Array EQ:

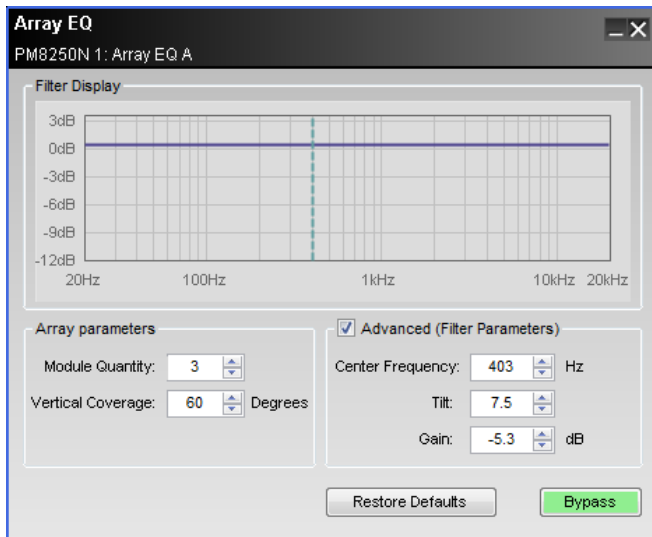

Filter Display – displays a graphical representation of array equalization settings in both frequency and level. The line represents the composite frequency response of chosen array and advanced filter parameters.

Array Parameters – specifically for use with Progressive Directivity Arrays.

Module Quantity – selects the quantity of loudspeaker modules within the array.

Vertical Coverage – enters the total vertical coverage angle, in degrees, of the array.

Advanced (Filter Parameters) – the Array EQ is represented by three basic filter controls: Center Frequency, Tilt, and Gain. Using these controls, the basic array filter may be modified.

Center Frequency – center frequency of the filter, represented by the dashed line in the Response Graph.

Tilt - adjusts the start and end points of the filter's slope on either side of the center frequency. Tilt is adjustable between 0 and 10 in steps of 0.3, the greater the tilt the steeper the filter slope.

Gain - amount of boost or cut applied to the filter below the center frequency. Gain is adjustable in 0.3 dB steps between -12 and +2 dB.

Bypass - bypasses the array equalization (flat response).

Automatic Microphone Mixers

Automatic Microphone Mixer - Gated (ESPs only)

The **Automatic Microphone Mixer - Gated** processing block for ESP sound processors manages the signal level from multiple microphones to achieve a constant output level without user intervention. The processing block is available in three configurations: 4x1, 6x1, and 8x1.

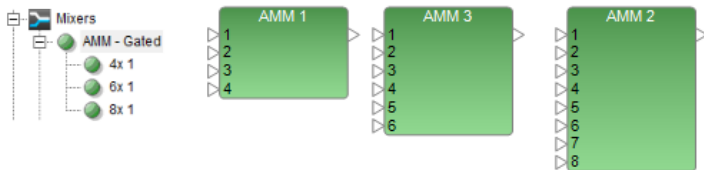

AMM-Gated blocks

AMM Gated Control Panel

Double click on the AMM - Gated block in Signal Processing View to open its control panel.

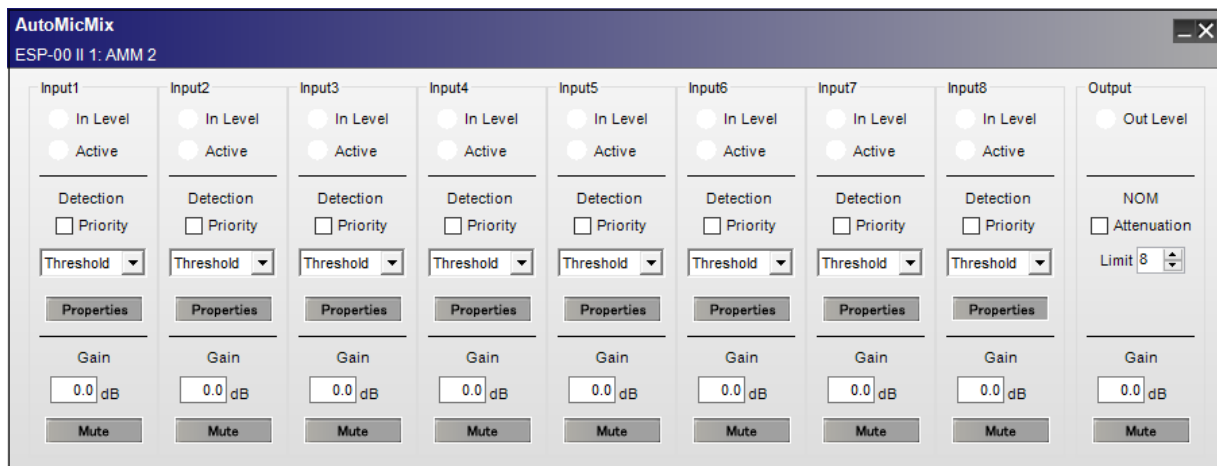

AMM-Gated 8x1 control panel

The **Automatic Microphone Mixer - Gated** control panel provides the following controls:

Input - specifies each input channel.

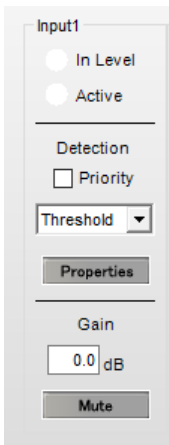

AMM-Gated input control panel

In Level – a three-color status indicator to illustrate the range of the current input signal level. Colors indicate the following input ranges:

Green > 36 dBFS

Yellow -20 to -6 dBFS

Red > -6 dBFS

Active – a three-color status indicator to illustrate the current input activity of the signal processing block:

White Off (inactive)

Light Blue Active

Dark Blue Active input, but at a reduced level due to a higher priority channel

Detection – settings determine when the input channel turns on automatically:

Priority – when selected, forces other non-priority input channels to duck or reduce in level when this channel gates on. Multiple input channels can have Priority checked. Any channel with Priority selected will duck non-priority channels but will not duck another priority channel.

Threshold – enables a channel gate to open when a predetermined signal level is reached. When the signal drops below this threshold, the channel gate closes once more.

LastOn – allows a channel to remain open even after it falls below the threshold. The channel continues to remain open until another channel becomes active.

PushToTalk – requires a trigger to open the channel. This trigger can be from a control panel push button or from a programmed GPI event.

Bypass – forces the channel to remain open at all times by circumventing the detection circuitry.

Properties – opens an additional control panel to adjust settings for each of the detection methods.

Available options within this control panel are:

Advanced – expands the properties available with an additional option for **Detection Settings** and a new section entitled **Gate Settings**.

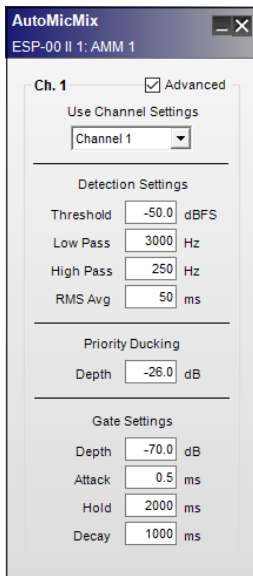

AMM-Gated advanced section of input control panel

Use Channel Settings - applies the settings from a specified channel to the current channel, thereby overriding the current channel settings.

Detection Settings - determine the gating method used for the input channel.

Threshold - default value is -50 dBFS, and the range is from 80 to -50 dBFS.

Low Pass - cut-off frequency default is 3 kHz, and the range is from 300 to 20 kHz.

High Pass - cut-off frequency default is 250 Hz, and the range is 20 to 1 kHz.

RMS Avg - available only when the **Advanced** option is selected. Value is the duration in milliseconds, of the RMS averaging performed on the detection signal chain. The default is 50 ms, and the range is 1 to 500.

Priority Ducking - determines the amount of ducking applied to the channel when the priority channel is open. The default is 26.0 dB, and the range is -60.0 to 0.0 dB.

Gate Settings - are available only when the **Advanced** option is selected. Options are:

Depth - is the amount of attenuation applied when the input gate is not open. The default is -70.0 dB, and the range is -70.0 to 0.0 dB.

Attack - is the amount of time, in milliseconds, from when the gate is turned on until it is fully open. The default is 0.5 ms, and the range is 0.5 to 100.0.

Hold - is the amount of time the gate will remain open once the signal is no longer present. The default is 2000 ms, and the range is 1 to 50,000.

Decay - is the amount of time required for the gate to transition from its open to fully attenuated state. The default is 1000 ms, and the range is 5 to 50,000.

Gain - adjusts the post-gate output level of the input channel.

Gain value - is entered directly into the box or by right clicking the box to activate a gain slider. The range of adjustment is $-\infty$ to 0 dBFS (default).

Mute - attenuates the input channel. When Mute is enabled, the control panel button is Red.

Output - this section of the control panel includes an Output Level indicator, Number of Open Microphones options, and Gain options.

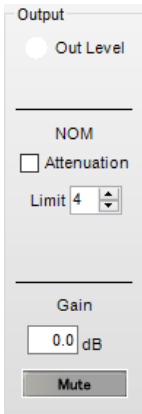

AMM output control panel

Out Level – is a three-color indicator to display the output channel level:

Green > 36 dBFS

Yellow -20 to -6 dBFS

Red > -6 dBFS

NOM– provides options related to the Number of Open Microphones.

Attenuation - activates the NOM attenuation function. This will apply $-10 \cdot \log(\text{NOM})$ output attenuation to the channel.

Limit - determines the maximum number of microphones that may be active at any time. The range of values is from 1 to the total number of channels in the selected Automatic Microphone Mixer processing block: 4, 6, or 8.

NOTE: If the Limit value is less than the number of microphones which are active, the following logic is used to determine which microphones are selected:

Priority – channels meeting all other conditions take precedence over non-priority channels.

First-come, first-served – activates channels in the order that required conditions are met and held.

Lowest-numbered channel – activates sequentially starting with the smallest numerically valued channel and in ascending order thereafter until the NOM limit is reached.

Gain - adjusts the overall output level of the AMM-Gated block.

Gain value – is entered directly into the box or by right clicking box to activate a gain slider. The range of adjustment is $-\infty$ to 0 dBFS (default).

Mute - attenuates the output channel. When Mute is enabled, the control panel button is Red.

AMM - Gated Block Functional Block Diagram

The AMM - Gated functional diagram illustrates the signal flow of the block.

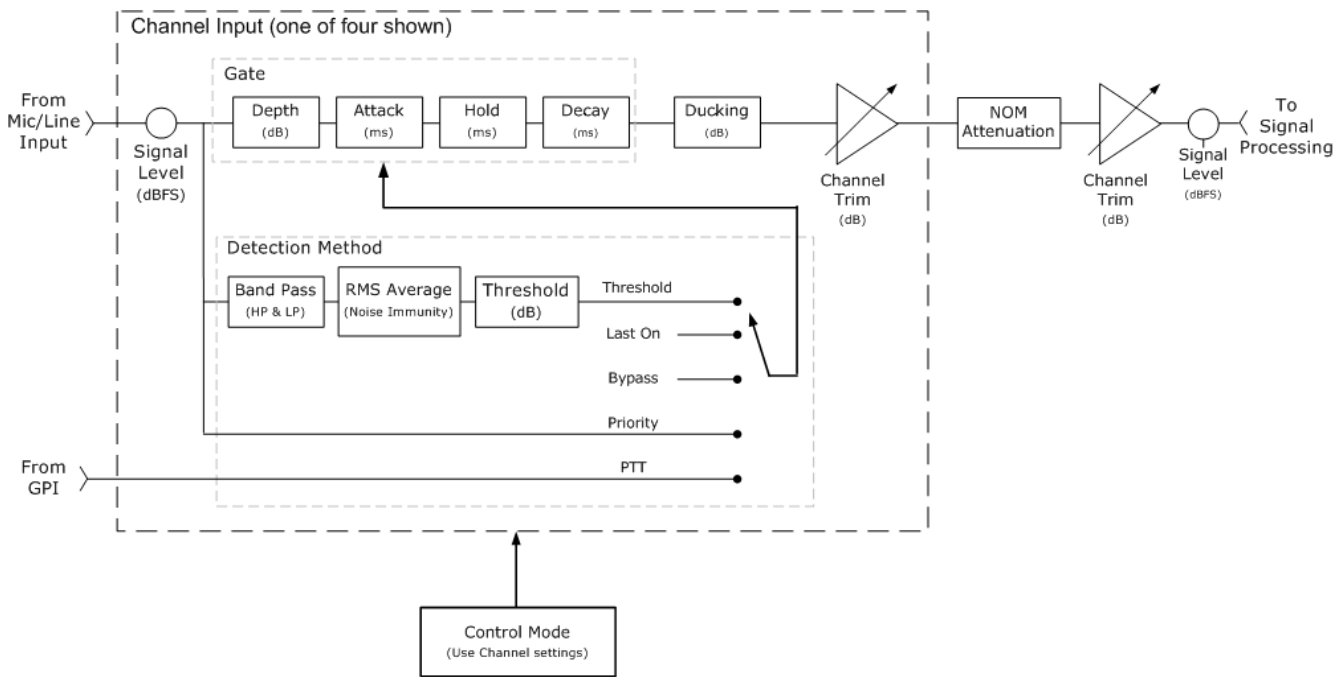

AMM- Gated block functional block diagram

Automatic Microphone Mixer - Gain Sharing

The Automatic Microphone Mixer (AMM) - Gain Sharing SP block for the ESP-880/1240/1600/4120 and EX-1280C sound processors assigns gain values across multiple input channels such that the total gain of the system remains the same. Each input channel is attenuated by an amount equal to the difference between that channel's level and the sum of all channel levels, in dB. When using this algorithm, the strongest signals are attenuated the least and the weakest signals are attenuated the most.

NOTE: The ESP-00 II does not support AMM - Gain Sharing functionality.

Setting the Number of Channels

The AMM - Gain Sharing block supports from 4-32 input channels. To set the number of mic input channels for an AMM - Gain Sharing block:

1. Drag the AMM - Gain Sharing block into Signal Processing View.
2. In the AMM dialog, select or type in the number of mic input channels, using the Number of mics selector control.

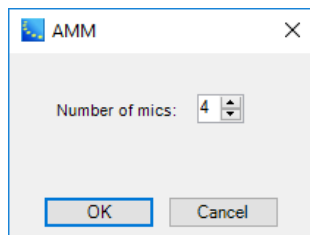

3. Click **OK** to add the block to the Signal Processing View.

You can add inputs to an existing block at any time by right clicking on the block and selecting **Change Channel Count**. You can then select the number of channels to add, up to a maximum of 32.

Logic Support (EX-1280C Only)

For the EX-1280C sound processor only, you can control the mute function of the mix output and control the mute state of each channel via logic inputs. The current state of each mute is communicated via logic

output ports. For more information on logic support for AMM - Gain Sharing blocks, see [Logic and Testing Support for SP Blocks](#).

Linking AMM - Gain Sharing Blocks (EX-1280C Only)

You can expand the number of channels by linking multiple AMM - Gain Sharing blocks together (see [Linking AMM Blocks to Extend Channels](#)). You can also link these blocks on different sound processors or establish a link by connecting an AMM - Gain Sharing block with the Conference Room Router block. When you link multiple blocks, you need to set the link mode of each block to Master or Slave. If you are not using multiple linked blocks, you should set the link mode of the AMM - Gain Sharing block to Standard.

NOTE: The ESP sound processors do not support the linking of any AMM blocks, Gated or Gain Sharing.

AMM - Gain Sharing Block Configurations

There are several AMM - Gain Sharing block output configurations available. Default standard unlinked block provides a single output channel that outputs only the **Mix**.



AMM Gain-Sharing Block - Standard with four inputs and a mix output

Direct Output Block - You can configure the block to output not only the **Mix** but also a **Direct Output** for each input channel. To add direct output channels to the block, right click on the block and select **Enable Direct Outputs**.



AMM Gain-Sharing Block - Standard with mix and direct outputs

Master Link Mode Block - If the Link mode is set to Master for the block, Mix and Chain ports are added to the input side, and Sum is added to the output side. The Master block is designated with an **M** in the lower-right corner of the block:

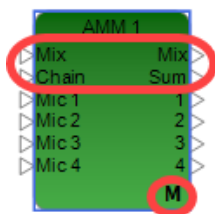

AMM Gain-Sharing Block - Master with mix and direct outputs

Slave Link Mode Block - If the Link mode is set to Slave for the block, Mix, Sum, and Chain ports are added to the input side, and Chain is added to the output side. The Slave block is designated with an **S** in the lower-right corner of the block:

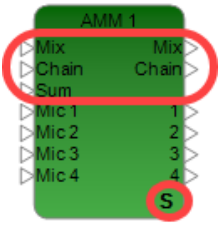

AMM Gain-Sharing Block - Slave with mix and direct outputs

AMM Gain Sharing Block Control Panel

Double-click on the AMM - Gain Sharing block in Signal Processing View to open its control panel.

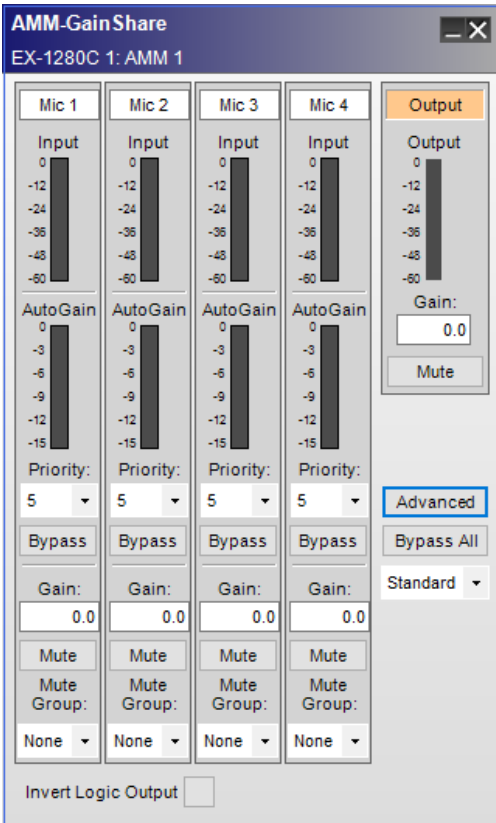

AMM - Gain Sharing Control Panel - Offline

Here is the view of the same control panel on-line with input and output signals.

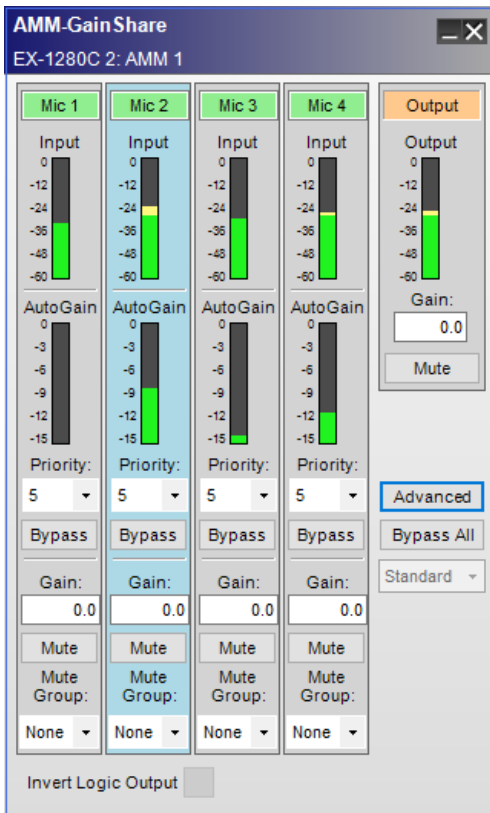

AMM - Gain Sharing Control Panel - On-line

When on-line, the background color of the channel with the highest gain turns light blue. If a signal is present in a channel, the background color of the Mic label turns green.

The **Automatic Microphone Mixer - Gain Sharing** control panel provides the following controls for each input:

Mic - specifies each microphone input channel. The input channel label can be renamed by the user. When in on-line mode, the background color of the label turns green if a signal is present.

Input - indicates the signal level coming into the microphone, in dBFS.

AutoGain - indicates the gain that is applied to the channel by the algorithm, in dB.

Priority - assigns a priority level to each channel. Setting a channel's priority level causes the algorithm to treat the channel as if its level were higher than it actually is. This results in microphones with higher priority receiving more gain relative to the others. Priority level 1 is the highest priority level. Priority level 5 applies no priority adjustment, and is the default priority level for all microphones.

Bypass - removes the channel from the algorithm and allows its signal to pass through the mixer with no attenuation. A bypassed channel does not affect the algorithm's auto-gain calculations.

Gain - adjusts the post-gate output level of the input channel. The range of adjustment is $-\infty$ to 12 dB. Default value is 0 dB.

Mute - silences the input channel. Mute is applied pre-auto-gain; therefore, a muted channel's signal level *does not* affect the algorithm's auto-gain calculations.

Mute Group - determines the mute group number of the channel. The muting operation of multiple channels which have the same mute group number is synchronized; that is, if one mic in mute group 1 is muted, all mics in mute group 1 will be muted. Select None (default) or assign a mute group number from 1 to the total number input channels minus 1. "None" means the mute function of this channel is not synchronized with other channels.

Output - this section of the control panel includes an Output Level indicator, Gain setting, and Mute button. It also includes advanced options, Bypass All setting and Link mode selection.

Output - indicates the output level from the block, in dBFs.

Gain - adjusts the overall output level of the AMM - Gain Sharing block.

Mute - silences all output from the mixer.

Advanced - expands the properties available, with an additional options for **Output slope** and **Time Constants**.

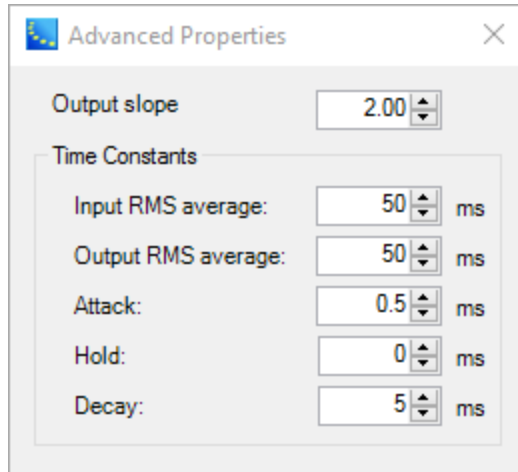

AMM - Gain Sharing advanced properties dialog

Output slope - default value for output slope is 2.00. An output slope of 2.00 means that each channel will receive exactly the amount of gain that the algorithm assigned to it. The value of the output slope can be set to any value between 0.01 and 2.00. When the output slope is at its minimum value, 0.01, the auto-mix-gain equals almost 1 (before being converted to dB). Any slope between the minimum and maximum will be an auto-mix-gain value between its originally assigned value and 1.

Time Constants

Input RMS average - length, in milliseconds (ms), of the RMS averaging for the detection of signal levels. Default value is 50.0 ms.

Output RMS average - length, in milliseconds (ms), of the RMS averaging for the detection of the output level. Default value is 50.0 ms.

Attack - amount of time, in milliseconds (ms), from when the microphone signal is detected until it is fully open. Default value is 0.5 ms, and the range is 0.5 to 100.0 ms.

Hold - amount of time, in milliseconds (ms), that the microphone will remain open once the signal is no longer present. Default value is 0 ms.

Decay - amount of time, in milliseconds (ms), required for the microphone to transition from its open state to its fully attenuated state. Default value is 5.0 ms.

Bypass All - allows all signals to pass through the mixer with no attenuation.

Link mode - sets one of the following link modes for the block:

Standard - unlinked mode (default). Use this if you are not linking any blocks.

Master - when you link blocks without CRR, you must set the link mode of one block to **Master**.

Slave - when you link blocks, you must set any block to **Slave** link mode that is not set to Master link mode.

Invert Logic Output - when this option is selected, the logic output of the block is **High** when the block's audio output is unmuted and **Low** when the block's audio output is muted. If this option is not

selected, the logic output of the block is **Low** when the block's audio output is unmuted and **High** when the block's audio output is muted. For more information on logic support for AMM - Gain Sharing blocks, see [Logic and Testing Support for SP Blocks](#).

AMM - Gain Sharing Functional Block Diagram

The AMM - Gain Sharing functional diagram illustrates the signal flow and logic operations of the block.

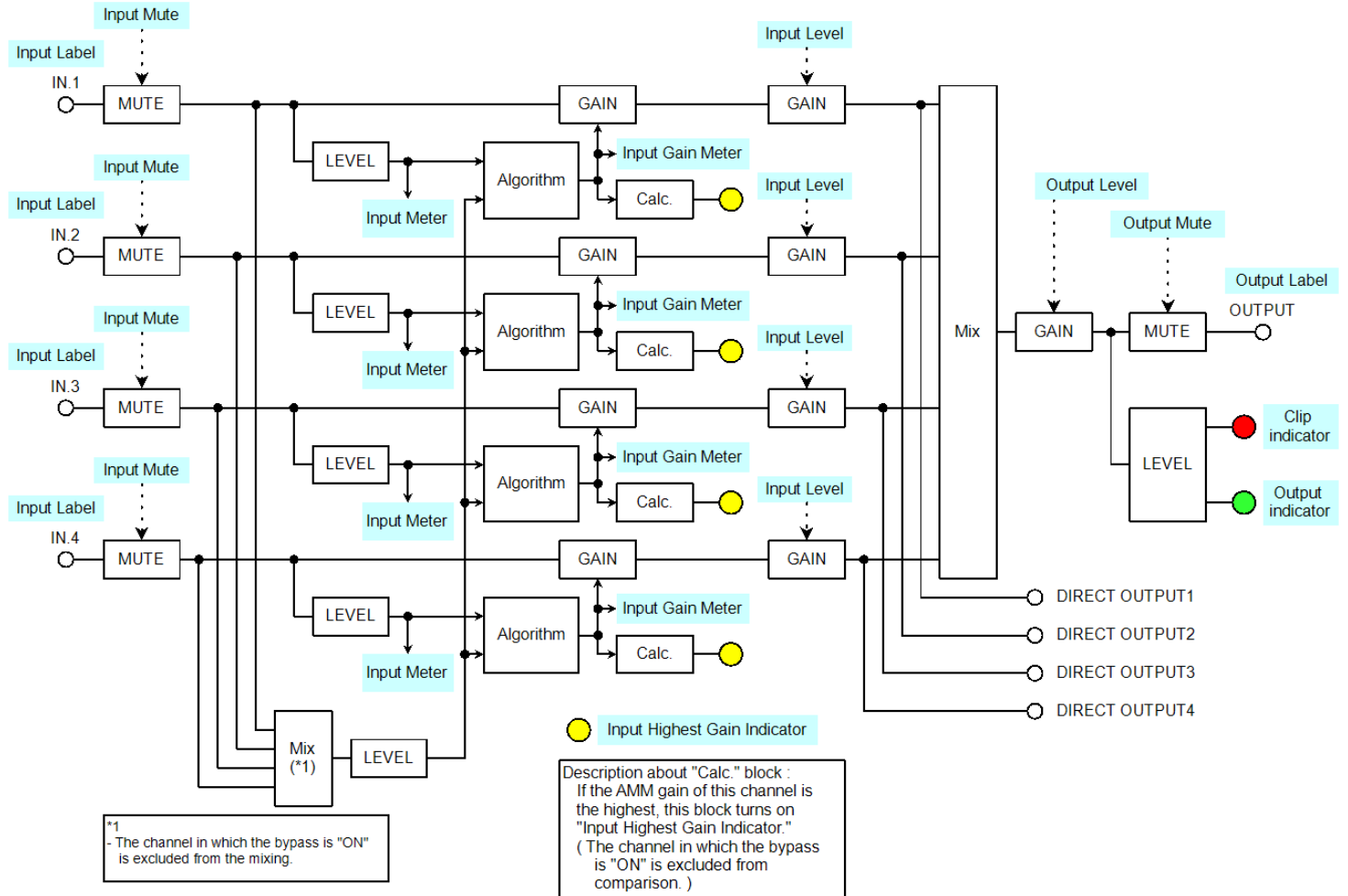

AMM - Gain Sharing functional block diagram

Compressor/Limiter

Compressor/Limiter processing reduces the level of an input signal when it reaches a predetermined threshold. Both a monaural Compressor/Limiter with one input and a side-chain input, and a stereo Compressor/Limiter with stereo inputs and a side-chain input are supported.

Control panels for mono and stereo versions differ only in the choice of input trigger signals.

Double-click on the Compressor/Limiter block in Signal Processing View to open its control panel.

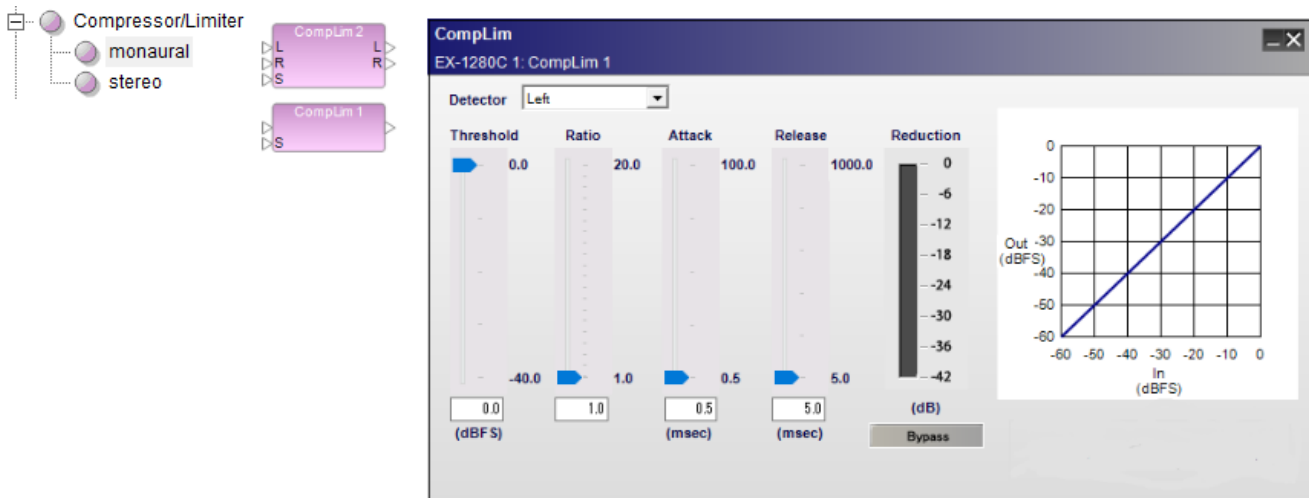

Stereo Compressor/Limiter processing block and control panel

The Compressor/Limiter control panel provides the following options:

Detector – determines which incoming signal is sent to the detector circuit (or trigger) to activate the signal processing.

Input - (mono only) indicates the input signal is the trigger for processing.

Left - (stereo only) indicates the left signal is the trigger for processing.

Right - (stereo only) indicates the right signal is the trigger for processing.

Mix - (stereo only) indicates a left/right signal mix is the trigger for processing.

Side-chain - indicates an alternate signal connected to the side-chain input is the trigger for signal processing.

Threshold slider – determines the level of the detector signal at which the processing block will begin adjusting the input signal. When the signal drops below this threshold, the input signal is not affected by the processing block.

Threshold gain value – is entered directly into the box. The range of adjustment is -40 to 0 dBFS (default) and tracks the threshold slider setting.

Ratio slider – establishes an input/output ratio for signals above the threshold. Signals exceeding the threshold are reduced by an amount according to the ratio. For example, when using a compression ratio of 10:1, a 10dB change in the input level results in only a 1dB change at the output of the processor for all signals above the threshold level setting.

Ratio value – is entered directly into the box. The range of adjustment is 1.0 (default) to ∞ and tracks the threshold slider setting.

Attack slider – establishes the rate in milliseconds at which input signals are processed once they exceed threshold.

Attack value – is entered directly into the box. The range of adjustment is from 0.5 milliseconds (default) to 100 milliseconds.

Release slider – determines the rate in milliseconds when signal processing is discontinued after threshold is exceeded.

Release value – is entered directly into the box. The range of adjustment is from 5 milliseconds (default) to 1000 milliseconds.

Reduction meter – displays a vertical bar level indicator to illustrate the amount of signal reduction applied based upon the currently defined processing values.

Bypass – forces the channel to remain open at all times by circumventing the detection circuitry.

Compressor/Limiter graph - illustrates the input level versus the output level of the signal in a graphical manner. The slope of the line indicates the compression ratio.

Filters/Crossovers

A crossover divides an input signal into two or more frequency ranges, and sends each range (or band-pass) to a separate output. The SP Tool Kit offers 2-way, 3-way, and 4-way crossovers. The controls and functions are identical other than the number of outputs.

2-way crossover

A 2-way crossover divides an input signal into two frequency ranges, high and low, and sends these signals to two outputs marked H (high) and L (low). Double-click on the 2-way crossover block within the signal processing view to open its control panel.

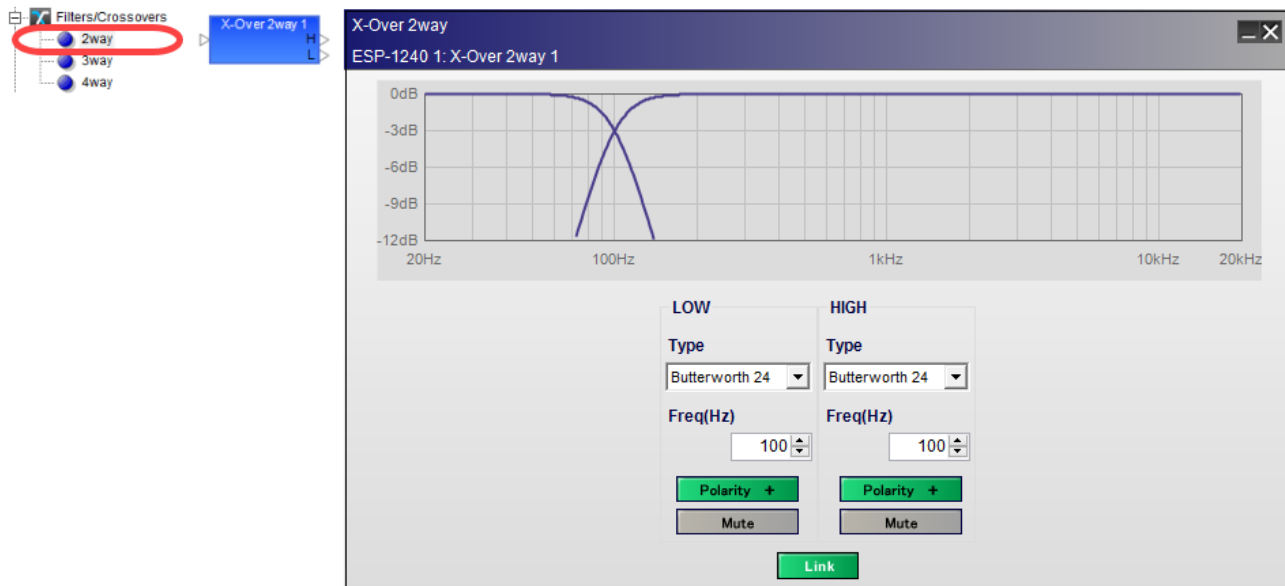

2-way crossover, processing block and control panel

The **2-way crossover control panel** provides the following options:

Crossover Graph - displays a graphical representation of adjustable crossover filter settings in both frequency and level. The line to the left represents the low frequency output level and the line to the right represents the high frequency output level.

LOW - adjusts the low frequency filter parameters.

Type - selects the filter type. The filter type and slope may be set independently for each filter in the crossover block.

Options include:

Type	Slope	Type	Slope	Type	Slope
Butterworth 6	6 dB/oct				
Butterworth 12	12 dB/oct	Bessel 12	12 dB/oct		
Butterworth 18	18 dB/oct	Bessel 18	18 dB/oct	Linkwitz-Riley 12	12 dB/oct

Type	Slope	Type	Slope	Type	Slope
Butterworth 24	24 dB/oct	Bessel 24	24 dB/oct	Linkwitz-Riley 24	24 dB/oct
Butterworth 36	36 dB/oct	Bessel 36	36 dB/oct	Linkwitz-Riley 36	36 dB/oct
Butterworth 48	48 dB/oct	Bessel 48	48 dB/oct	Linkwitz-Riley 48	48 dB/oct

Freq(Hz) - specifies the specific filter frequency via direct entry or by using the spinner controls. Adjustments may be made in 1Hz increments. When the Link option is engaged, the frequency of the adjacent filter is also changed.

Polarity - inverts the polarity to the filter. When *Polarity* is normal, the control panel button is Green and a plus (+) sign is present. When *Polarity* is reversed, the control panel button is Red and a minus (-) sign is present.

Mute - mutes the audio output for the frequency band. When Mute is enabled, the control panel button is Red.

HIGH - adjusts the high frequency filter parameters.

Type - selects the filter type and slope.

Options are identical to low frequency filter parameters.

Freq(Hz) - specifies the specific filter frequency via direct entry or by using the spinner controls. Adjustments may be made in 1Hz increments. When the Link option is engaged the frequency of the adjacent filter is also changed.

Polarity - inverts the polarity to the filter. When *Polarity* is normal, the control panel button is Green and a plus (+) sign is present. When *Polarity* is reversed, the control panel button is Red and a minus (-) sign is present.

Mute - mutes the audio output for the frequency band. When Mute is enabled, the control panel button is Red.

Link -matches the adjacent filters to the same frequency. This option is only available if the adjacent filter types are both Butterworth or both Linkwitz-Riley filter types. If the Link button is off, the filter frequencies can be set independently.

3-way crossover

A 3-way crossover divides an input signal into three frequency ranges, high, low mid, and low, and sends these signals to three outputs marked H (high), M (mid), and L (low). Double-click on the 3-way crossover block within the signal processing view to open its control panel.

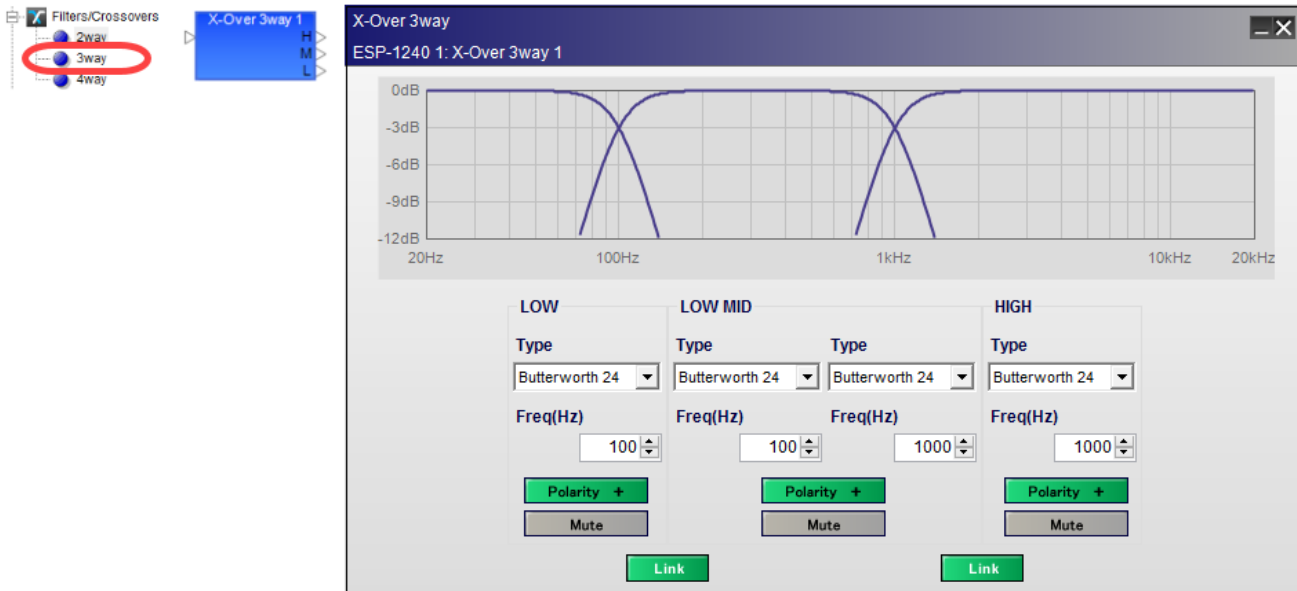

3-way crossover, processing block and control panel

The **3-way crossover control panel** provides all the options of the 2-way crossover plus:

LOW MID - adjusts the mid frequency filter parameters.

Type - selects the filter type and slope. The upper and lower filters for the bandpass are individually set. Options include:

Type	Slope	Type	Slope	Type	Slope
Butterworth 6	6 dB/oct				
Butterworth 12	12 dB/oct	Bessel 12	12 dB/oct		
Butterworth 18	18 dB/oct	Bessel 18	18 dB/oct	Linkwitz-Riley 12	12 dB/oct
Butterworth 24	24 dB/oct	Bessel 24	24 dB/oct	Linkwitz-Riley 24	24 dB/oct
Butterworth 36	36 dB/oct	Bessel 36	36 dB/oct	Linkwitz-Riley 36	36 dB/oct
Butterworth 48	48 dB/oct	Bessel 48	48 dB/oct	Linkwitz-Riley 48	48 dB/oct

Freq(Hz) - specifies the specific filter frequency via direct entry or by using the spinner controls. Adjustments may be made in 1Hz increments. When the Link option is engaged, the frequency of the adjacent filter is also changed.

Polarity - inverts the polarity to the filter. When *Polarity* is normal, the control panel button is Green and a plus (+) sign is present. When *Polarity* is reversed, the control panel button is Red and a minus (-) sign is present.

Mute - mutes the audio output for the frequency band. When Mute is enabled, the control panel button is Red.

Link - matches the adjacent filters to the same frequency. This option is only available if the adjacent filter types are both Butterworth or both Linkwitz-Riley filter types. If the Link button is off, the filter frequencies can be set independently.

4-way crossover

A **4-way crossover** divides an input signal into four frequency ranges, high, high mid, low mid, and low, and sends these signals to four outputs marked H (high), HM (high mid), LM (low mid), and L (low).

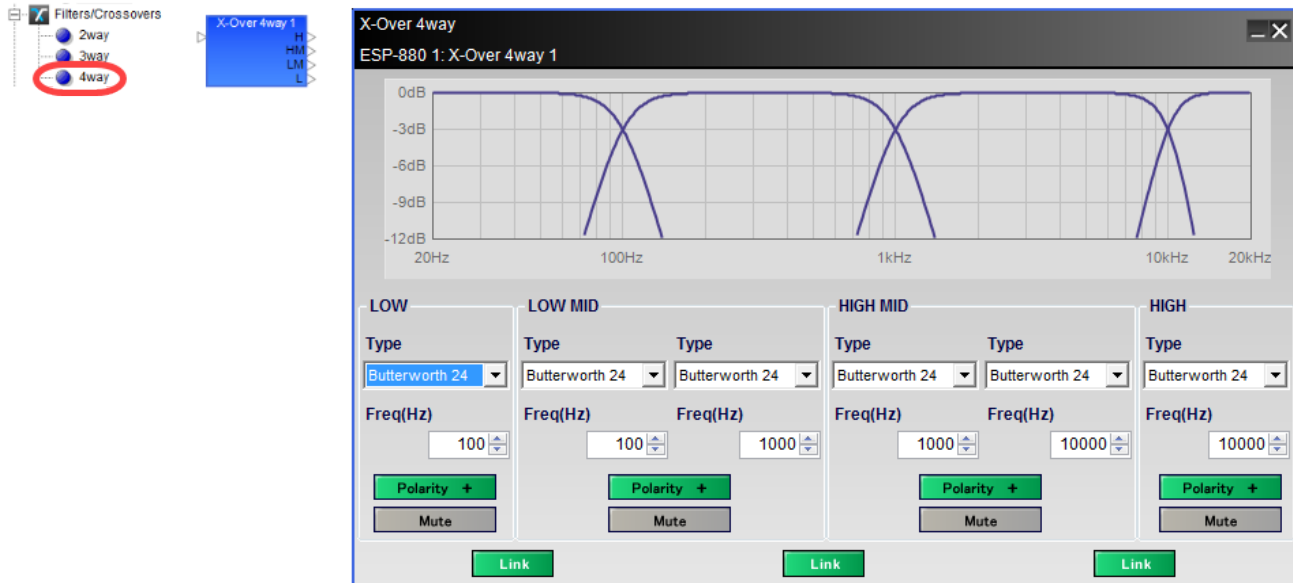

4-way crossover, processing block and control panel

The **4-way crossover control panel** provides all the options of the 3-way crossover plus:

HIGH MID – adjusts the mid frequency filter parameters.

Type – selects the filter type and slope. The upper and lower filters for the bandpass are individually set. Options include:

Type	Slope	Type	Slope	Type	Slope
Butterworth 6	6 dB/oct				
Butterworth 12	12 dB/oct	Bessel 12	12 dB/oct		
Butterworth 18	18 dB/oct	Bessel 18	18 dB/oct	Linkwitz-Riley 12	12 dB/oct
Butterworth 24	24 dB/oct	Bessel 24	24 dB/oct	Linkwitz-Riley 24	24 dB/oct
Butterworth 36	36 dB/oct	Bessel 36	36 dB/oct	Linkwitz-Riley 36	36 dB/oct
Butterworth 48	48 dB/oct	Bessel 48	48 dB/oct	Linkwitz-Riley 48	48 dB/oct

Freq(Hz) – specifies the specific filter frequency via direct entry or by using the spinner controls. Adjustments may be made in 1Hz increments. When the Link option is engaged, the frequency of the adjacent filter is also changed.

Polarity – inverts the polarity to the filter. When *Polarity* is normal, the control panel button is Green and a plus (+) sign is present. When *Polarity* is reversed, the control panel button is Red and a minus (-) sign is present.

Mute – mutes the audio output for the frequency band. When Mute is enabled, the control panel button is Red.

Link - matches the adjacent filters to the same frequency. This option is only available if the adjacent filter types are both Butterworth or both Linkwitz-Riley filter types. If the Link button is off, the filter frequencies can be set independently.

Delay

Delay blocks insert delay (time) into the audio signal chain. The SP Tool Kit offers delays blocks with one, two, four, and eight outputs. Delay values for each output are set individually.

Double-click on the Delay block in Signal Processing View to open its control panel.

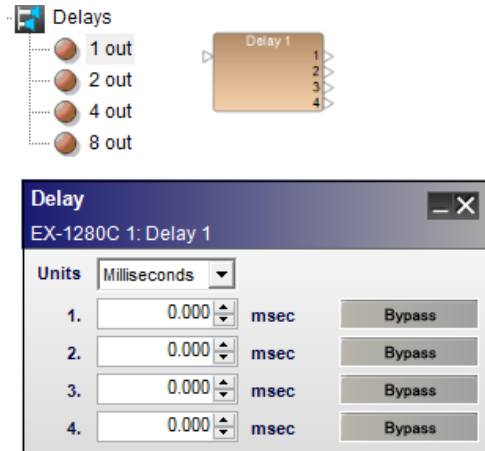

Four-channel Delay processing block and control panel

The **Delay control panel** provides the following options:

Units – defines the unit of measure for signal delay. **NOTE: Distance units are based on the speed of sound, which is affected by temperature. The reference temperature setting is found in the Tools> Set Temperature window.** Supported units are:

Milliseconds (0-1000 ms)

Sample (0-48,000 samples)

Meter (0-343.7 m)

Millimeter (0-343,700 mm)

Feet (0-1127.625 ft)

Inch (0-13,531.496 in)

Output Delay – adjusts the signal delay delivered to the next signal processing block. The range of adjustment varies according to the units chosen.

Bypass – removes the signal delay from the associated output. When bypass is active, the button turns green. When inactive, the button is gray.

Ducker

The Ducker reduces the level of an input signal when an alternate signal is present on the side-chain input. Both a monaural Ducker with one input and a side-chain input, and a stereo Ducker with stereo inputs and a side-chain input are supported.

Control panels for mono and stereo versions are identical.

Double-click on the Ducker block in Signal Processing View to open its control panel.

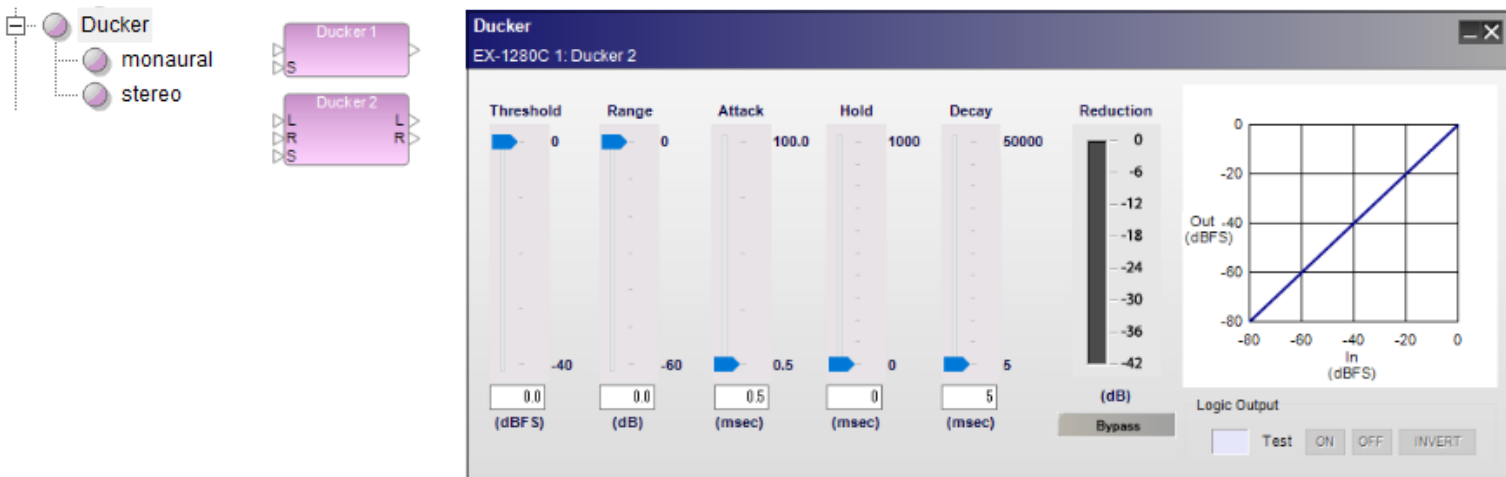

Ducker processing blocks and control panel

The Ducker control panel provides the following options:

Threshold slider – determines the level of the side-chain signal at which the processing block will begin adjusting the audio input signal. When the side-chain signal drops below the threshold value, the audio signal is unaffected.

Threshold gain value – is entered directly into the box. The range of adjustment is -40 to 0 dBFS (default) and tracks the threshold slider setting.

Range slider – dictates the amount of signal attenuation when the ducker is active.

Range value – is entered directly into the box. The range of adjustment is -60 to 0 dB (default) and tracks the range slider setting.

Attack slider – establishes the rate in milliseconds at which input signals are processed once they exceed threshold.

Attack value – is entered directly into the box. The range of adjustment is from 0.5 milliseconds (default) to 100 milliseconds.

Hold slider – determines the length in time (milliseconds) that the audio signal remains attenuated once the side-chain signal level drops below the threshold setting.

Hold value – is entered directly into the box. The range of adjustment is from 0 milliseconds (default) to 1000 milliseconds.

Decay slide – establishes the rate in milliseconds at which the audio signal returns to its normal state once the hold time expires.

Decay value – is entered directly into the box. The range of adjustment is from 5 milliseconds (default) to 50000 milliseconds.

Reduction meter – displays a vertical bar level indicator to illustrate the amount of signal reduction that has been applied.

Bypass – bypasses the detection circuit. The audio signal level is unaffected.

Ducker graph - illustrates the input level versus the output level of the signal in a graphical manner.

Logic Output options - for information on logic support for Ducker blocks, see [Logic and Testing Support for SP Blocks](#).

NOTE: The side-chain input signal is only used as a trigger signal, it is not passed to the ducker output. To hear this signal, you must mix it back in to the signal chain along with the Ducker output.

Gain

Gain blocks provide a convenient method to add individual gain control points within a system design. These blocks use the fewest CPU resources of any other signal processing element and are helpful in many applications.

Setting the Number of Ports

To set the number of input and output ports for a Gain block:

1. Drag the Gain block into Signal Processing View.
2. In the Gain dialog, you can select a standard 1x1, 2x2, 4x4, or 8x8 port block. Alternatively, you can select or type in the number of ports (8 max) using the Input ports selector control.

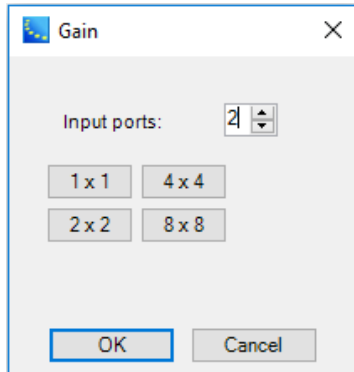

3. Click **OK** to add the block to the Signal Processing View.

The number of channels may be modified by right clicking on the block and selecting **Change Channel Count**. The maximum number of channels is 8.

Gain Block and Control Panel

Double-click on the Gain block in Signal Processing View to open its control panel.

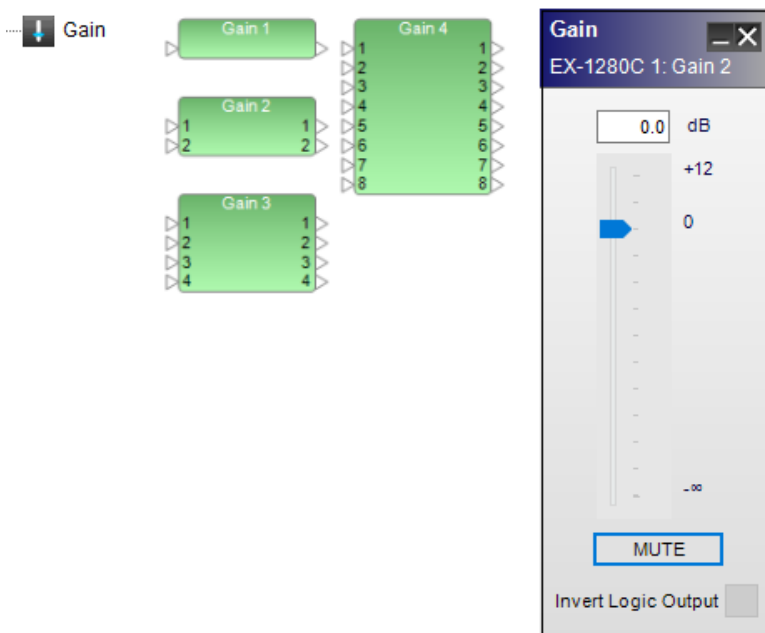

Gain processing blocks and control panel

The **Gain control panel** provides the following options:

Gain Value – permits direct entry of desired signal level in dB. Range of adjustment matches and tracks the input gain slider.

Gain Slider – adjusts the input signal level delivered to the next signal processing block. The range of adjustment is from $-\infty$ to +12dB.

Mute – silences the signal and disables audio from passing to the next signal processing block in the design. When Mute is enabled, the control panel button is Red.

Invert Logic Output – when this option is selected, a **High** logic input results in a **Low** output and the main audio is unmuted. A **Low** logic input results in a **High** output and the main audio is muted. For more information on logic support for Gain blocks, see [Logic and Testing Support for SP Blocks](#).

Gate

Gate attenuates input signals below the designated threshold. Both a monaural Gate with one input and a side-chain input, and a stereo Gate with stereo inputs and a side-chain input are supported.

Control panels differ only in the choice of input signal used as the trigger signal.

Double-click on the Gate block in Signal Processing View to open its control panel.

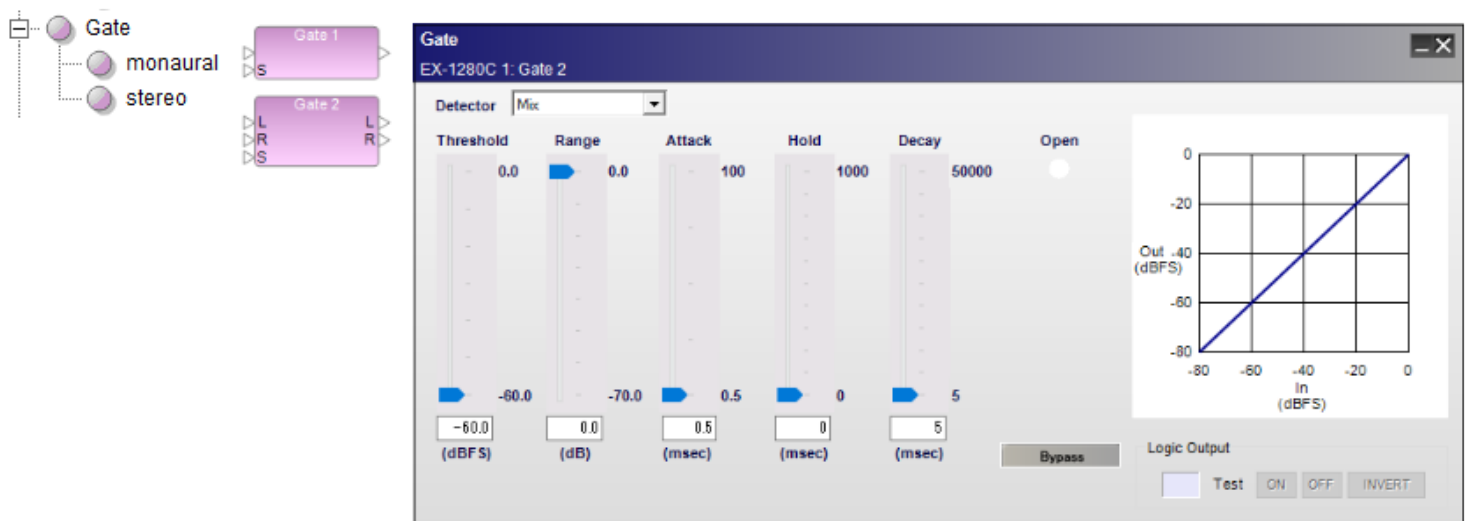

Gate processing blocks and control panel for stereo gate, with side-chain enabled

The Gate control panel provides the following options:

Detector – determines which incoming signal is sent to the detector circuit to activate the signal processing.

Input - (mono only) indicates the input signal is the trigger for processing.

Left - indicates the left signal is the trigger for processing.

Right - indicates the right signal is the trigger for processing.

Mix - indicates a left/right signal mix is the trigger for processing.

Side Chain - indicates an alternate signal connected to the side-chain input is the trigger for processing.

Threshold slider – determines when the processing block will begin adjusting the input signal. When the input or side-chain signal drops below the threshold value, the audio signal will not pass through the processing block.

Threshold gain value – is entered directly into the box. The range of adjustment is -60 to 0 dBFS (default) and tracks the threshold slider setting.

Range slider – dictates the amount of reduction in volume when the Gate is active.

Range value – is entered directly into the box. The range of adjustment is -70 to 0 dB (default) and tracks the range slider setting.

Attack slider – establishes the rate in milliseconds at which input signals are processed once they exceed threshold.

Attack value – is entered directly into the box. The range of adjustment is from 0.5 milliseconds (default) to 100 milliseconds.

Hold slider – determines the length in time (milliseconds) that the audio signal remains unattenuated once the Detector signal level drops below the threshold setting.

Hold value – is entered directly into the box. The range of adjustment is from 0 milliseconds (default) to 1000 milliseconds.

Decay slider – establishes the rate in milliseconds at which the audio signal returns to a gated state once the Detector signal level drops below the threshold setting.

Decay value – is entered directly into the box. The range of adjustment is from 5 milliseconds (default) to 50000 milliseconds.

Open – is an indicator to illustrate signal is passing through the gate to its output. When the gate is closed and no signal is passing, the indicator is White. When the gate is open and signal is passing, the indicator is Blue.

Bypass – forces the channel to remain open at all times by circumventing the detection circuitry.

Gate graph - illustrates the input level versus the output level of the signal in a graphical manner. The line represents the effect of the gate processing values.

Logic Output options - for information on logic support for Gate blocks, see [Logic and Testing Support for SP Blocks](#).

1/3 Oct Graphic EQ

The 1/3 Oct Graphic EQ boosts or cuts the output level at 31 different frequencies and at 1/3 octave intervals from 20 Hz to 20 kHz. Double-click on the 1/3 Oct Graphic EQ block in Signal Processing View to open its control panel.

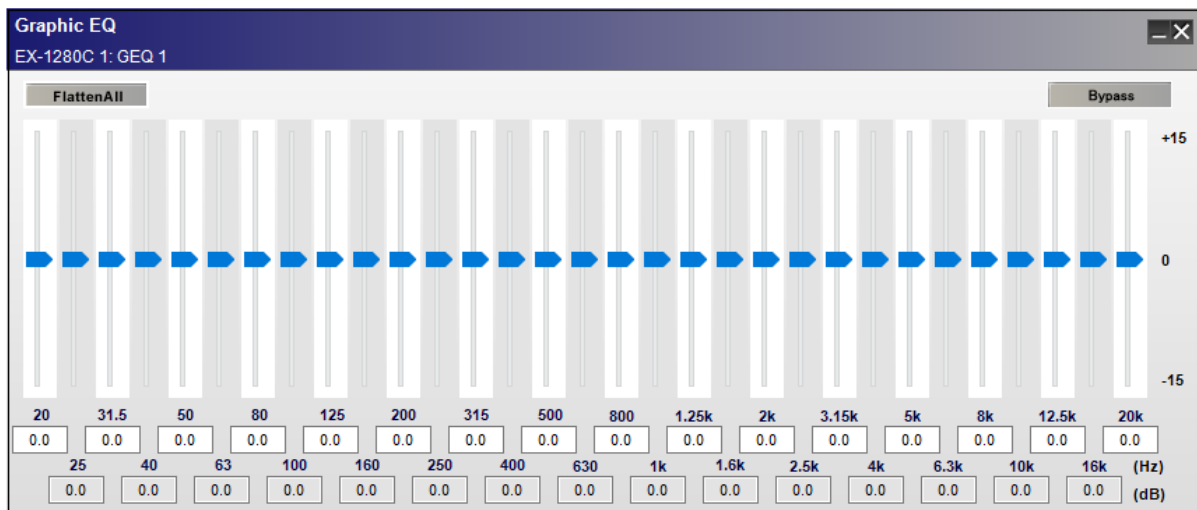
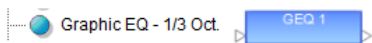

1/3 Oct Graphic EQ, processing block and control panel

The **1/3 Oct Graphic EQ control panel** provides the following options:

Flatten All – resets all gain sliders to zero.

Bypass – disables all equalizer settings from affecting the signal.

Gain Sliders – are adjustable for each frequency to boost or cut the level from -15 dB to 15 dB. Type in a boost or cut value in the input box below each slider to set the gain.

Matrix Mixer

The Matrix Mixer is used to combine (mix) and route input and output signals. Unlike the standard mixer, the input signal levels may be adjusted at each individual routing point or crosspoint.

Setting the Number of Ports

To set the number of input and output ports for a Matrix Mixer block:

1. Drag the Matrix Mixer block into Signal Processing View.
2. In the Matrix Mixer dialog, you can select from list of pre-defined port configurations, such as 2x2, 2x4, 8x8, 8x16 and many others. Alternatively, you can select or type in the number of input and output ports (up to 32 each, max) using the Input and Output ports selector controls.

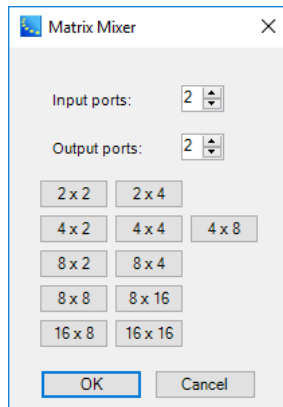

3. Click **OK** to add the block to the Signal Processing View.

You can modify the number of input and output channels by right clicking on the block and selecting **Change Channel Count**. The maximum number of input or output channels is 32.

Matrix Mixer Block and Control Panel

Double-click on the Matrix Mixer block in Signal Processing View to open its control panel.



Matrix Mixer processing blocks and 2x2 control panel

The **Matrix Mixer control panel** provides the following options:

Input and Output Labels– allow direct entry of user-defined labels for inputs or outputs.

Assign – creates a routing path between an input and an output. Select the assign box at the intersection of the two channels to permit audio to pass from input to output. When an assignment is made, the assign box turns blue.

Assign Level – provides a signal gain adjustment at the assignment cross-point. Right click on the assign box to access a gain slider. The range of adjustment is from $-\infty$ to 0.0dB.

Meters

Meters provide vertical bar level indicators for monitoring signals. Meter processing blocks are available in four, eight, and 16-channel versions. Double-click on a Meter block in Signal Processing View to open its control panel.

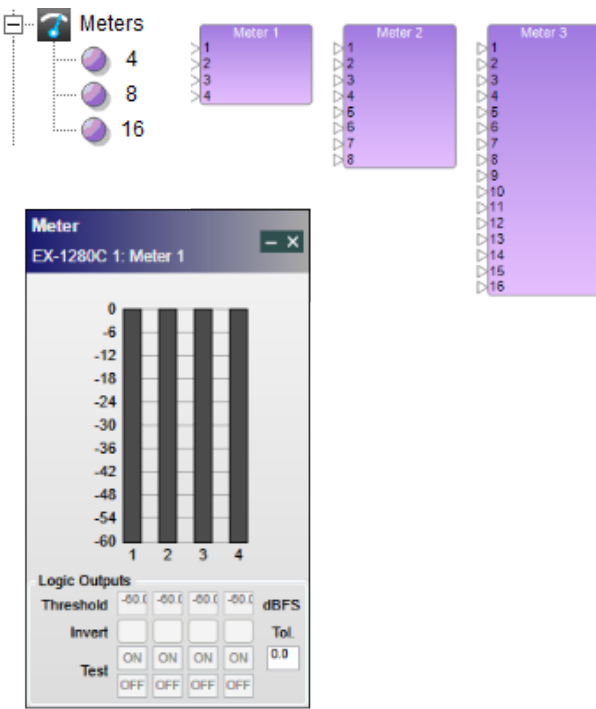

Meters processing blocks and control panel

The Meters control panel provides the following options:

Bar Level Indicators - provide a four-color graph to represent signal level. Values range from -60 to 0 dBFS (Full Scale). Color ranges are as follows:

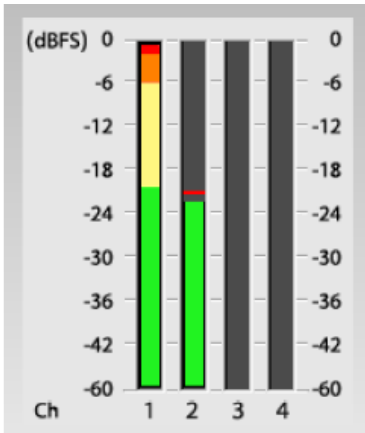

Green	-60 to -20 dBFS
Yellow	-20 to -6 dBFS
Orange	-6 to -2 dBFS
Red	-2 to 0 dBFS

Logic Output options - these options display only when **Show Logic I/O** is selected in the context menu for the block. For information on logic support for Meters blocks, see [Logic and Testing Support for SP Blocks](#).

Variable Parametric EQs

Variable parametric equalizer (VPEQ) signal processing blocks provide extensive control of individual equalization filters (or bands) to modify the frequency response of a signal. The user can control the type, center frequency, bandwidth, and gain of each filter. VPEQ SP blocks range between 3-16 individual filters (or bands) and are available in monoaural or stereo versions.

Selecting the Number of Bands

To select the number of bands for a VPEQ block:

1. Drag the mono or stereo VPEQ block into Signal Processing View.
2. In the PEQ dialog, you can select a standard 3, 5, 7, or 9 band block. Alternatively, you can select or type in the number of bands (16 max) using the Bands selector control.



3. Click **OK** to add the block to the Signal Processing View.



Mono and Stereo Variable Parametric EQ blocks

Variable PEQ Control Panel

To access the Variable PEQ control panel, double click the VPEQ block in Signal Processing View.

The control panels for each block differ only in the number of bands available for boost or cut. The mono and stereo blocks have the same control panel features.

	Type	Freq (Hz)	Q	Gain (dB)	Bypass
1	PEQ	1000	1.000	0.0	Bypass
2	PEQ	1000	1.000	0.0	Bypass
3	PEQ	1000	1.000	0.0	Bypass
4	PEQ	1000	1.000	0.0	Bypass
5	PEQ	1000	1.000	0.0	Bypass
6	PEQ	1000	1.000	0.0	Bypass
7	PEQ	1000	1.000	0.0	Bypass
8	PEQ	1000	1.000	0.0	Bypass
9	PEQ	1000	1.000	0.0	Bypass

Example: Mono 9-Band Variable Parametric EQ control panel

The **Variable Parametric EQ control panel** provides the following options:

Snapshot – provides a method to define and store multiple versions of the SP block settings for quick recall within a particular SP block. To recall a user-defined snapshot, select one of the stored snapshots from the drop-down list. Snapshot definitions are saved within the .CSP project file.

Name - for convenience, each snapshot can be given a familiar name when stored. When no name is entered, a default name is automatically generated. **NOTE: The snapshot named "Default Setting" will always return all filters to the default (flat) state and cannot be updated.**

Store – commits the current settings to the Snapshot list after entering a custom name. **NOTE: Stored snapshots are only available within the current SP block.**

Delete – removes a currently recalled snapshot definition from the Snapshot list. Deleting a snapshot does not alter the current block settings.

NOTE: VPEQ settings may be exported as a separate .PEQ file using the **Save Settings button in the control panel.**

VPEQ Graph – displays a graphical representation of adjustable parametric filter settings in both frequency and level. The dark horizontal line on the graph represents the EQ curve and the blue boxes represent the center frequency of each filter band.

By default, all center frequencies are positioned at 1000 Hz, so the blue boxes are all at the same point. You may adjust the center frequency and gain for each filter band via direct entry or by dragging the blue box with your mouse in the PEQ Graph.

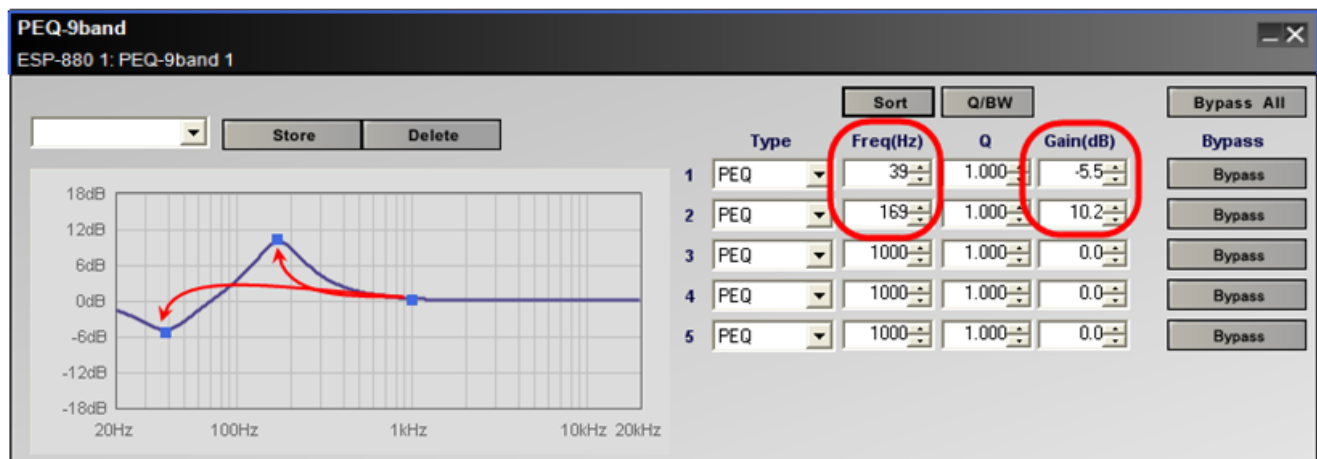

Load / Save Settings – all VPEQ settings may be saved and exported as a separate .PEQ file on the computer. A .PEQ file can be loaded into VPEQ blocks in other .CSP project files.

Sort – reorders the list of filters by frequency from low to high.

Q/BW – provides a toggle switch between the two unit systems representing filter bandwidth. Q is the ratio of the center frequency divided by the bandwidth. The BW option is more commonly used and indicates octave bandwidth of the filter. Modification of this field is only possible for Parametric (PEQ) and Notch filter types.

Type – is a drop-down list of unique filter types available for use on each EQ filter. Filter type descriptions and illustrations are shown below:

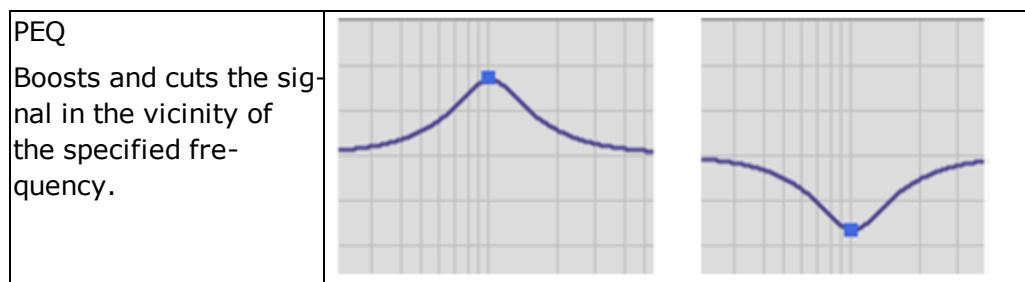

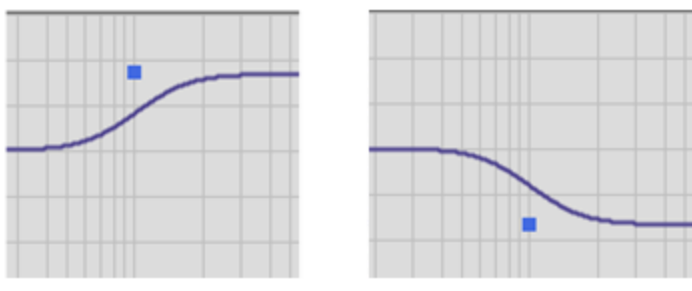
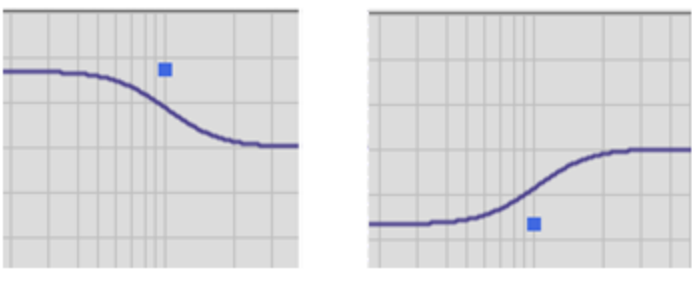
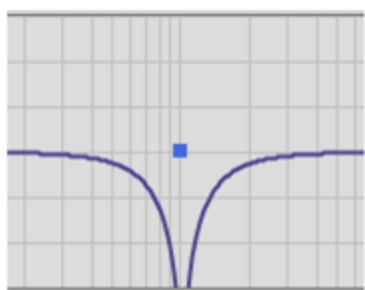
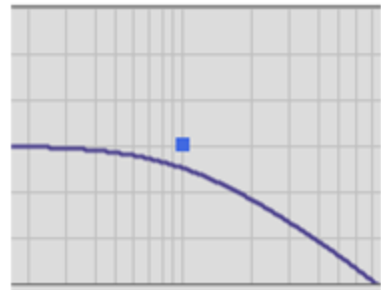
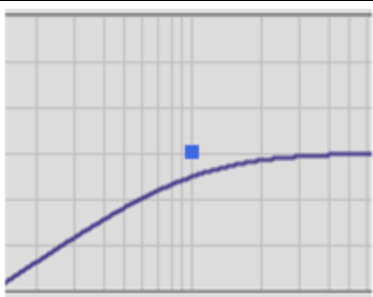
<p>High Shelf</p> <p>Boosts and cuts the signal above the specified frequency.</p>	
<p>Low Shelf</p> <p>Boosts and cuts the signal below the specified frequency.</p>	
<p>Notch</p> <p>Attenuates the signal at the specified frequency.</p>	
<p>Low Pass</p> <p>Attenuates the signal above the specified frequency.</p>	
<p>High Pass</p> <p>Attenuates the signal below the specified frequency.</p>	

Parametric filter types

Frequency – specifies the center frequency of the filter band in Hertz (Hz). The range of permitted values entered directly into the text box or by using the scroll buttons is 20 Hz to 20 kHz.

Q or BW – value representing filter width. This column displays either **Q** or **BW** depending on the state of the **Q/BW** toggle button directly above this column. When using filter types other than PEQ or Notch, this field is not available.

Gain – is the amount of cut or boost applied to the filter in dB, from -20 to 20. When using Low Pass and High Pass filters, this field is used to adjust the slope of the attenuation curve (-6 dB/Oct, or -12 dB/Oct).

Bypass All – engages all individual bypass buttons simultaneously. When active, the button turns green. When inactive, the button is gray.

Bypass – use the Bypass buttons to remove an individual filter from the signal chain. When active, the button turns green. When inactive, the button is gray.

Add/Delete Band– adds or deletes a band from the list.

Peak RMS Limiter

The Peak vs. RMS Limiter processing can be set to protect speakers from thermal damage when excessive power is applied for long periods of time (RMS limiting), and mechanical damage due to over-exursion (Peak Limiting).

NOTE: To properly protect loudspeakers, Peak and RMS levels must be calibrated with the actual amplifier output voltage according to the loudspeaker specifications.

Both a monaural version with one input and a side-chain input, and a stereo version with stereo inputs and a side-chain input are supported.

Control panels for mono and stereo versions differ only in the choice of input trigger signals.

Double-click on the Peak RMS Limiter block in Signal Processing View to open its control panel.

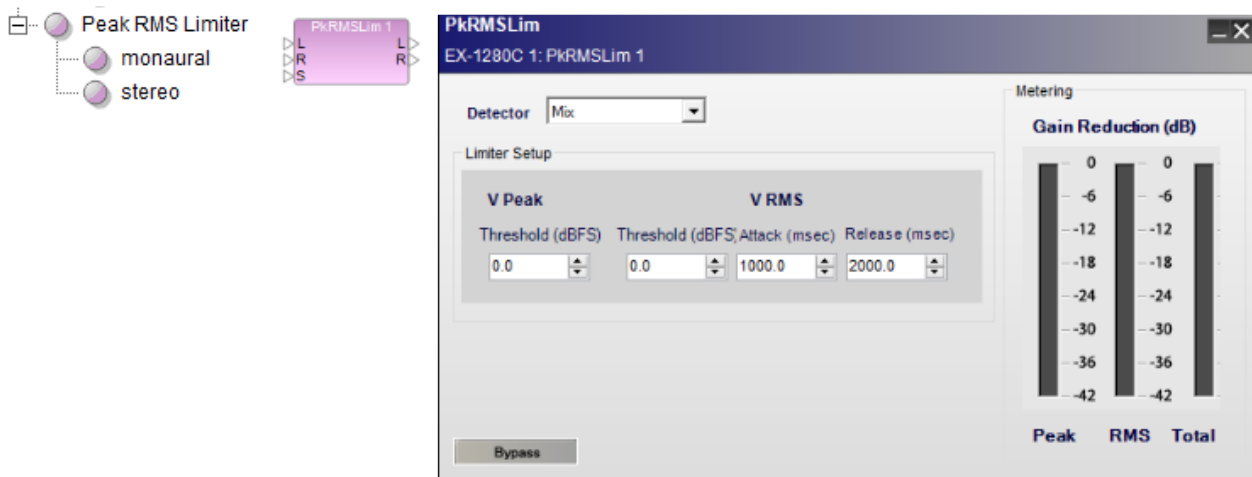

Peak RMS Limiter block and control panel for stereo limiter, with side-chain enabled

Detector - determines which incoming signal is sent to the detector circuit (or trigger) to activate the signal processing.

Input - indicates a monaural signal is the trigger for processing.

Left (Stereo only) - indicates the left signal is the trigger for processing.

Right (Stereo only) - indicates the right signal is the trigger for processing.

Mix (Stereo only) - indicates a left/right signal mix is the trigger for processing.

Side Chain - indicates that an alternate signal connected to the side-chain input is the trigger for processing.

Limiter Setup -

V Peak Threshold (dBFS) - determines the maximum signal level (dBFS) allowed to pass through the signal processing block. Input signal levels above the threshold will be reduced (or hard limited) to the V Peak Threshold value. The default value is 0dBFS and the range of adjustment is -40 to 0 dBFS.

V RMS Threshold (dBFS) - determines the maximum continuous RMS signal level (dBFS) allowed to pass unaltered through the signal processing block. Input signal levels above the threshold level will be reduced to the RMS Threshold value. The default value is 0dBFS and the range of adjustment is -40 to 0 dBFS.

V RMS Attack (msec) - determines the amount of time an RMS signal must exceed the RMS threshold level before the gain of the signal is reduced.

VRMS Release (msec) - determines the amount of time the input signal continues to be reduced after the detection signal drops below the RMS threshold setting.

Metering - Gain Reduction (dB) - meter bars display the amount of gain reduction for the Peak and RMS signal values, as well as the total reduction in gain.

Bypass - forces the channel to remain open at all times by circumventing the detection circuitry.

Predictive Feedback Suppression (PFS)

Predictive feedback suppression (PFS) is an equalization option that detects feedback in the incoming signal and automatically creates and applies filters at relevant frequency bands to reduce and suppress it. The gain levels of these dynamic filters gradually lower as they respond proportionally to the loudness of the feedback. After the feedback subsides and a predetermined length of time passes, the filters will release and return to their original gain levels. You can also apply static filters that will shape the frequency response whether or not feedback is detected.

Note: This is available for fixed-I/O ESP processors and EX-1280C only.

To add a predictive feedback suppression (PFS) block to your project:

1. When viewing the design workspace for a device, make sure the **SP Tool Kit** panel is shown. If it is not, click **Window** and click **Device List** so it is selected.
2. Make sure the **EQs** node is expanded. If it is not, double-click it.
3. Click and drag **Predictive Feedback Suppression** onto the design workspace.



To edit a predictive feedback suppression (PFS) block, do one of the following:

Double-click the **PFS** block in the design workspace.

Right-click the **PFS** block in the design workspace and click **Open**.

Click the **PFS** block in the design workspace and press **Enter**.

Filters

Predictive feedback suppression uses two types of notch filters: static and dynamic. While editing a PFS block, you can create, edit, bypass, or delete each type of filter. You can also convert each type of filter to the opposite type by using the **Static** and **Dynamic** button next to the **Q/BW** button.

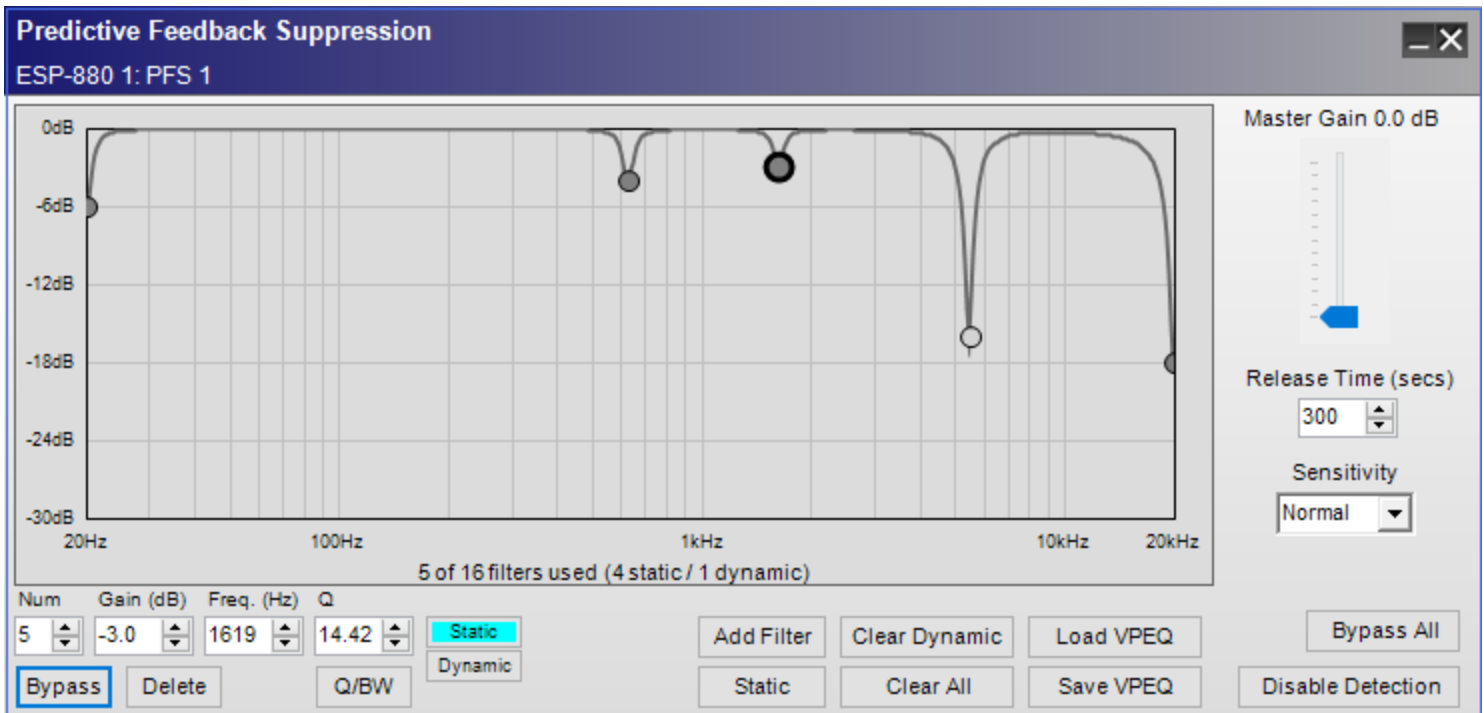

Each PFS block includes the following controls:

VPEQ Graph: A graphical representation of all filters in the PFS block. Each filter is represented by a circle. A variable parametric equalizer (VPEQ) provides extensive control of individual equalization filters to modify the frequency response of a signal. The filters in this VPEQ, however, specifically reduce feedback in the signal. You can control the type, center frequency, bandwidth, and gain of each static filter, whereas dynamic filters will be automatically created and adjusted when feedback is detected.

The X axis represents the frequency range: 20 Hz to 20 kHz. The Y axis represents the range of gain adjustment: 0 dB to -30 dB.

A PFS block can contain 1-16 filters. The total number of filters used—and how many of each type are used—is shown under the graph.

The currently selected filter is outlined by a **bold, black** circle.

A static filter is represented by a **dark gray** circle.

A dynamic filter is represented by a **light gray** circle.

If a filter of either type (static or dynamic) is bypassed, the frequency curve will not dip at that point in the graph.

Master Gain: Adjusts the overall output signal level of the PFS block. Use this setting to increase the gain while ringing out the system. Keep this setting at 0.0 dB during normal live operation. The range of this setting is 0.0 dB to +12 dB.

Release Time (secs): Determines the amount of time the output signal continues to be affected by the dynamic filters after the feedback is no longer detected. The range of this setting is 1 second to 43200 seconds (12 hours). The default setting is 300 seconds (5 minutes).

Sensitivity: Determines how feedback is suppressed based on the type of audio signal. The available settings are **Normal** and **Reduced**. The default setting is **Normal**.

Num: This is the number of the currently selected filter. Use this field to select a filter in the VPEQ. The filters are numbered sequentially in the order they are added.

Gain (dB): Defines how much the filter cuts (reduces the signal at) the frequency band. Alternatively, press and hold **Shift** while clicking and dragging the filter up or down (this restricts the filter's movement in the graph to its vertical axis). The range of this setting is 0.0 dB to -24.0 dB.

Freq. (Hz): Defines the frequency in hertz where the filter is applied. Alternatively, press and hold **Ctrl+Shift** while clicking and dragging the filter left or right (this restricts the filter's movement in the graph to its horizontal axis). The range of this setting is 20 Hz to 20000 Hz.

Q or **BW:** Defines the “width” of the filter as **Q** (resonance) or **BW** (bandwidth). The range of the **Q** setting is 0.10 to 14.42, while the range of the **BW** setting is 0.10 to 6.67. Alternatively, press and hold **Ctrl** while clicking and dragging the filter up or down. You can switch between the **Q** and **BW** settings by clicking **Q/BW**.

Static/Dynamic: Switches the filter type between static and dynamic. The turquoise button indicates the state of the currently selected filter. Alternatively, press and hold **Alt** while clicking the filter, or right-click the filter and then select **Lock Filter** or **Unlock Filter**. (You can convert all filters to static filters by clicking **Static** [under the **Add Filter** button].)

Bypass: Bypasses or reactivates the currently selected filter. Alternatively, right-click the filter and then select **Bypass Filter**. (You can bypass all filters simultaneously or reactivate all filters that were not previously bypassed by clicking **Bypass All** instead.)

Delete: Removes the filter from the VPEQ graph. This cannot be undone. (You can remove all dynamic filters simultaneously by clicking **Clear Dynamic** instead.)

Q/BW: Switches the definition of the filter's “width” between **Q** (resonance) and **BW** (bandwidth).

Add Filter: Adds a filter to the VPEQ graph. A PFS block can contain 1-16 filters.

Static: Converts all filters to static filters. (You can switch the filter type for individual filters by selecting a filter and clicking **Static** or **Dynamic** instead.)

Clear Dynamic: Removes all dynamic filters from the VPEQ graph. This cannot be undone. (You can remove individual filters by clicking **Delete** instead.)

Clear All: Removes all active static and dynamic filters. (You can remove individual filters by clicking **Delete** instead.)

Load VPEQ: Opens your computer's browser window so you can select and load a previously saved VPEQ, which includes all filters and their settings shown in a PFS block. See [Saving & Loading VPEQ Files](#) to learn more.

Save VPEQ: Saves the current VPEQ, which includes all filters and their settings shown in the current PFS block. See [Saving & Loading VPEQ Files](#) to learn more.

Bypass All: Bypasses all filters simultaneously or reactivates all filters that were not previously bypassed. Bypassing all filters will also disable **Master Gain** and **Disable Detection**.

Disable Detection: Disables or enables feedback detection. When detection is disabled, the button will be green, and the PFS block will not detect any feedback that occurs (static filters will still affect the audio signal, and any currently active dynamic filters will remain active until the release time has elapsed). When detection is enabled, the button will be gray, and the PFS block will detect feedback in the incoming signal and automatically create and apply filters at relevant frequency bands to reduce and suppress it.

Static

A static filter is always active—regardless of the incoming signal's volume or frequency content—unless you bypass or delete it.

To convert a static filter to a dynamic filter, do one of the following:

Right-click it and select **Unlock Filter**.

Click it or use the **Num** field to select it, and then click **Dynamic** (next to the **Q/BW** button).

You can convert all filters to static filters by clicking **Static** (under the **Add Filter** button) instead.

Dynamic

A dynamic filter is created, activated, and deactivated automatically. As described earlier, these filters respond proportionally to the loudness of feedback detected in the incoming signal. They release after the feedback subsides and the predetermined release time elapses.

You can also create dynamic filters manually by unlocking static filters.

To convert a dynamic filter to a static filter, do one of the following:

Right-click it and select **Lock Filter**.

Click it or use the **Num** field to select it, and then click **Static** (next to the **Q/BW** button). Alternatively, change its **Gain**, **Frequency**, or **Q/BW** setting.

To enable or disable feedback detection, click **Disable Detection** in the lower-right corner. When detection is disabled, the button will be green, and the PFS block will not detect any feedback that occurs. This essentially bypasses all dynamic filters, though static filters will still affect the audio signal. When detection is enabled, the button will be gray, and the PFS block will detect feedback in the incoming signal and automatically create and apply filters at relevant frequency bands to reduce and suppress it.

Saving & Loading VPEQ Files

A VPEQ file (*.peq) contains all settings in a PFS block, including all filters and values.

To save the current PFS block as a VPEQ file, click **Save VPEQ**. In the window that appears, select a location to save the file, enter a file name, and then click **Save** or **Cancel**.

To load a VPEQ file to the current PFS block, click **Load VPEQ**. In the window that appears, select the location of the file, and then click **Open** or **Cancel**.

Note: The *.peq file extension used by PFS blocks is also used by VPEQ (parametric EQ) blocks. You can load a VPEQ file from a VPEQ block into a PFS block, but you may see an error message because PFS blocks do not support all settings of a VPEQ block. The error message will list the unsupported settings. If you see this message, select **Clamp**, **Drop**, or **Cancel**:

Clamp: Forces the loaded settings to conform those supported in the PFS block.

Drop: Loads all settings except for those unsupported in the PFS block.

Cancel: Cancels the loading of all settings.

Routers

Routers direct individual inputs to one or more outputs within a programmable SP block.

Setting the Number of Ports

To set the number of input and output ports for a Router block:

1. Drag the Router block into Signal Processing View.
2. In the Router dialog, you can select from list of pre-defined port configurations, such as 2x2, 2x4, 8x8, 8x16 and many others. Alternatively, you can select or type in the number of input and output ports (up to 32 each, max) using the Input and Output ports selector controls.

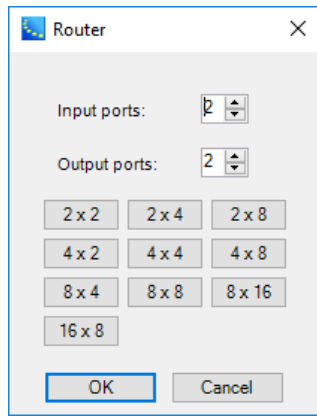

3. Click **OK** to add the block to the Signal Processing View.

You can modify the number of inputs or outputs at any time by right clicking on the block and selecting **Change Channel Count**. The numbers of input or output channels may be individually set between 2 and 32.

Router Block and Control Panel

Double-click on the Router block in Signal Processing View to open its control panel.

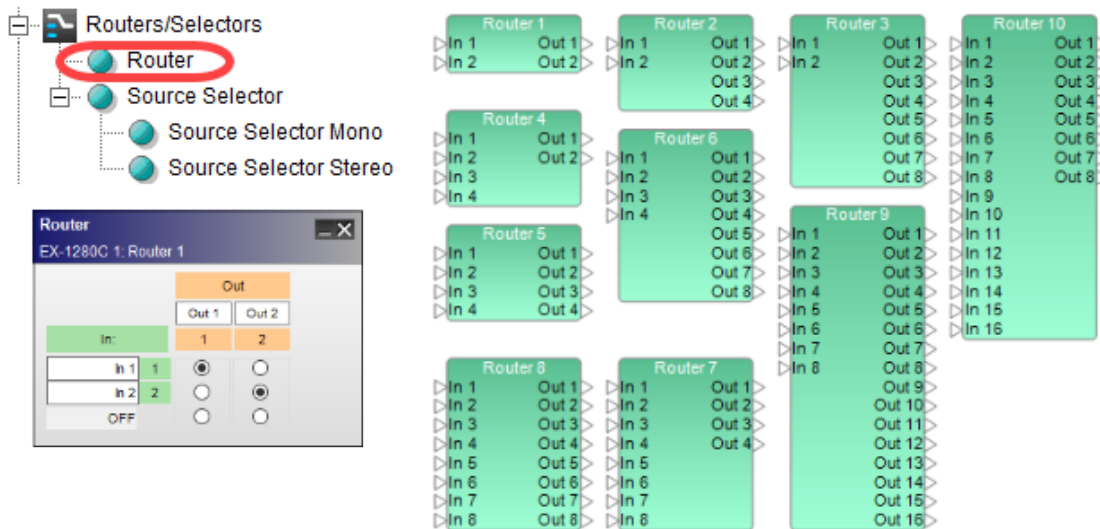

Router processing blocks and 2x2 control panel

The **Router control panel** provides the following options:

Input and Output Labels – allows direct entry of user defined labels for inputs or outputs.

Output Assignment – cross-point radio buttons select which input channel is routed to each output channel. To mute audio for an output channel, select the OFF cross-point on the bottom row under the input channels.

Source Selector

The Source Selector routes one of its input signals to an output channel. Both monaural and stereo source selectors are available.

Setting the Number of Channels

To set the number of input channels for a Source Selector block:

1. Drag the Mono or Stereo Source Selector block into Signal Processing View.
2. In the Source Selector dialog, you can select from list of pre-defined input channels. Alternatively, you can select or type in the number of input channels (up to 16 max) using the channels selector controls.

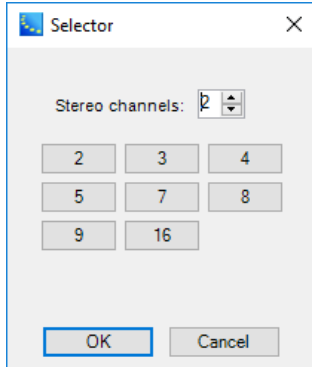

3. Click **OK** to add the block to the Signal Processing View.

You can modify the number of input channels by right clicking on the block and selecting **Change Channel Count**. The number of input channels may be set between 2 and 32.

Source Selector Block and Control Panel

Double-click on the Source Selector block in Signal Processing View to open its control panel.

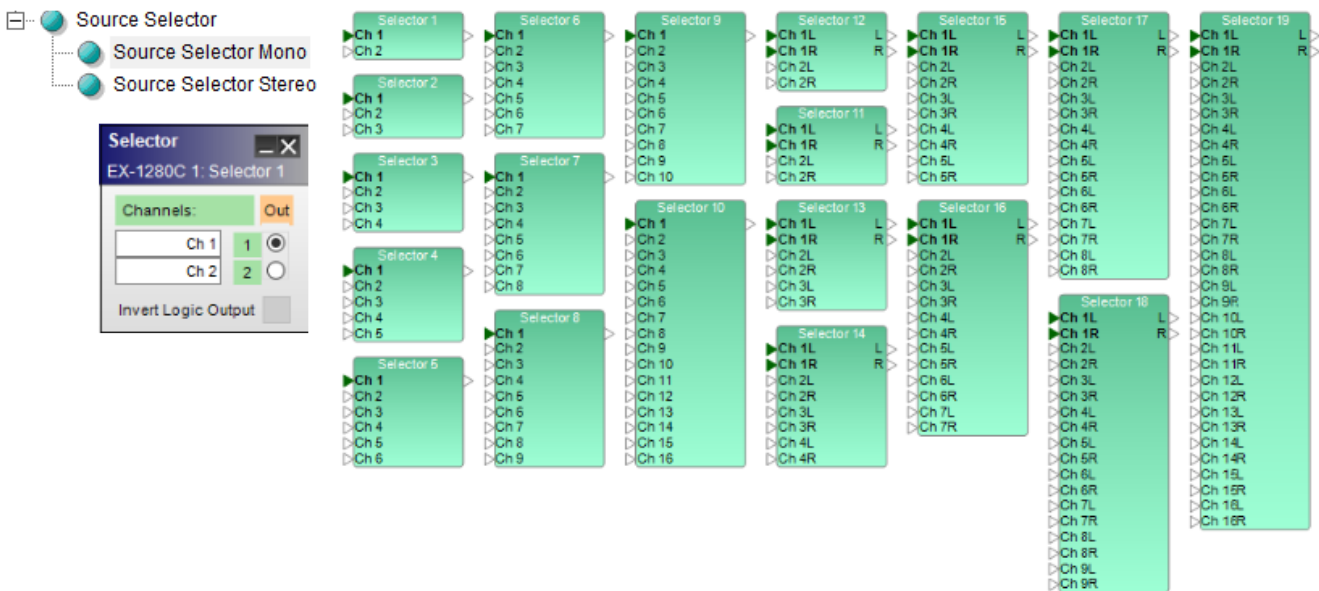

Source Selector processing blocks and mono - 2-channel control panel

The Source Selector control panel provides the following options:

Channel Labels– displays current channel name and allows direct entry of user-defined labels for channels.

Select Channel – in the Out column, the input channel may be selected by clicking on the cross-point, or by using the up/down arrow keys on the keyboard.

Invert Logic Output - when this option is selected, the corresponding logic output is set **Low** when a particular input channel is selected. All other logic outputs for this block will be **High**. For more information on logic support for Source Selector blocks, see [Logic and Testing Support for SP Blocks](#).

Speaker EQ

Speaker EQ signal processing blocks provide pre-configured equalization settings for Bose loudspeakers and bass arrays. Four Speaker EQ SP block types are provided:

- Single speaker output
- Crossover with high and low frequency speaker outputs
- Two-element bass array configurations
- Four-element bass array configurations

Double-click on the Speaker EQ block in Signal Processing View to open its control panel.

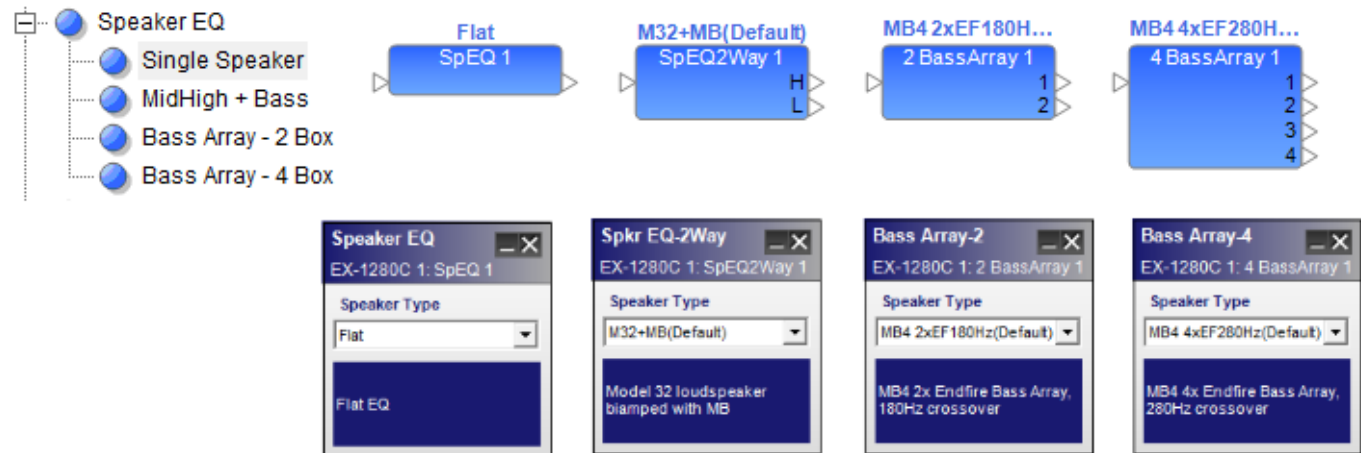

Speaker EQ processing blocks and control panels

Each **Speaker EQ control panel** provides the following options:

Speaker Type – drop down list with a selection of loudspeakers appropriate for the chosen EQ type.

EQ Description – provides a detailed list of product and configuration options unique to each speaker type.

Standard Room Combining (StRC)

Standard Room Combining (StRC) is a simpler alternative to the Conference Room Combining (CRC). This is useful if an application does not require the advanced, complex mixing features of the conference room router (CRR). Instead, multiple inputs are mixed down to just one channel with a single Volume control and Mute button.

IMPORTANT: Standard room combiners and conference room combiners cannot belong to the same RC Group.

IMPORTANT: All inputs and outputs for standard room combiner (StRC) and background music (BGM) blocks are mono.

Note: This is available for fixed-I/O ESP processors and EX-1280C only.

Creating & Managing StRC Blocks

To add a standard room combiner (StRC) block to your project:

1. When viewing the design workspace for a device, make sure the **SP Tool Kit** panel is shown. If it is not, click **Window** and click **Device List** so it is selected.
2. Make sure the **Mixers** node is expanded. If it is not, double-click it.
3. Click and drag **Standard Room Combiner** onto the design workspace.
4. In the **Room Combine: Configuration** window that appears, use the controls to set up the audio routing of the rooms:

Number of Rooms: This defines the total number of rooms. The range of this setting is 1 room to 16 rooms. An StRC block will be created for each room.

RC Group: This is the RC Group to which the room combiner is assigned.

Input: This defines how many inputs will be available to be routed to the combined rooms. The range of this setting is 1 input to 12 inputs. All of these inputs are mono.

Output: This is the mono output signal to be routed to the combined rooms.

BGM: This defines how many BGM sources will be available to be routed to the combined rooms. The range of this setting is 0 sources to 12 sources. All of these inputs are mono. See [Selecting Background Music \(BGM\)](#) to learn more about this.

OK: Click this to create the configuration.

Cancel: Click this to cancel the configuration.

Continue to Build: Click this to create the configuration and open the Room Combine Layout window (see [Combining Rooms](#) to learn about this).

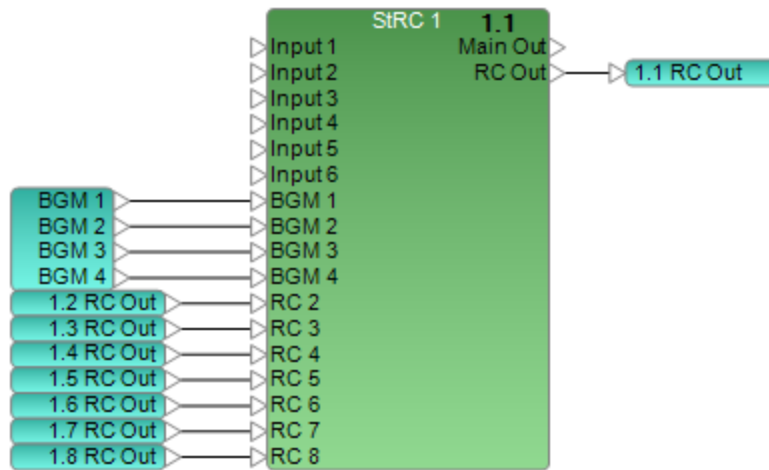

Each StRC block consists of:

Input: The available mono inputs (determined by the **Inputs** field).

BGM: The available mono background music (BGM) inputs (determined by the **BGM** field).

RC: Mono inputs that receive signals from the RC Outs of all other rooms in the RC Group (determined by the **Number of Rooms** field). If you add or remove rooms to or from the RC Group, these inputs will change to match the RC Outs of those rooms.

Main Out: The signal sent from this mono output is a mix of the block's standard inputs, BGM inputs, and RC inputs.

RC Out: The signal sent from this mono output is a mix of the StRC block's standard inputs, BGM inputs, and RC inputs. This signal is automatically connected to the corresponding RC input of all other StRC blocks in the RC Group.

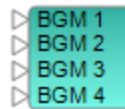

A BGM block consists of:

The available mono background music (BGM) inputs (determined by the **BGM** field).

To copy an StRC block, do one of the following:

Right-click the **StRC** block in the design workspace and click **Copy**.

Click the **StRC** block in the design workspace, click the **Edit** menu, and click **Copy**.

Click the **StRC** block in the design workspace, and press **Ctrl+C**.

To cut an **StRC** block, do one of the following:

Right-click the **StRC** block in the design workspace and click **Cut**.

Click the **StRC** block in the design workspace, click the **Edit** menu, and click **Cut**.

Click the **StRC** block in the design workspace, and press **Ctrl+X**.

Note: The RC inputs of all StRC blocks in the RC Group will automatically update to match the number of current rooms.

To paste an StRC block, do one of the following:

Right-click anywhere in the design workspace and click **Paste**.

Click anywhere in the design workspace, click the **Edit** menu, and click **Paste**.

Click anywhere in the design workspace, and press **Ctrl+V**.

Note: The RC inputs of all StRC blocks in the RC Group will automatically update to match the number of current rooms.

To duplicate an StRC block, do one of the following:

Right-click the **StRC** block in the design workspace and click **Duplicate**.

Click the **StRC** block in the design workspace, click the **Edit** menu, and click **Duplicate**.

Click the **StRC** block in the design workspace, and press **Ctrl+D**.

Note: The RC inputs of all StRC blocks in the RC Group will automatically update to match the number of current rooms.

To edit a standard room combiner (StRC) block, do one of the following:

Double-click the **StRC** block in the design workspace.

Right-click the **StRC** block in the design workspace and click **Open**.

Click the **StRC** block in the design workspace and press **Enter**.

See [Adjusting Volume & Muting](#) to learn how to edit each StRC block.

Selecting Background Music (BGM)

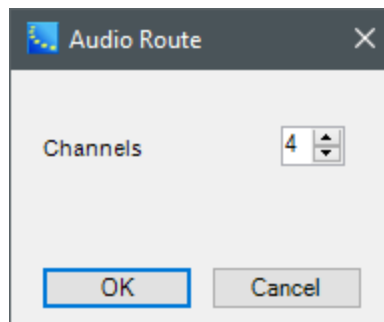

To change the number of BGM channels:

1. Right-click the **BGM** block in the design workspace and click **Change Channel Count**.
2. In the **Audio Route** window that appears, use the **Channels** field to change the number of channels.
3. Click **OK** to confirm your choice, or click **Cancel** to close the window without making any changes.

IMPORTANT: If you add or remove channels to or from the BGM block, the available BGM sources for each StRC block will change to match the BGM block, but the number of BGM inputs on each StRC block will remain the same.

Adjusting Volume & Muting

You can edit the volume levels, muting, and background music sources of all rooms in the layout (RC Group) by editing any of the StRC blocks in that RC Group.

To edit a standard room combiner (StRC) block, do one of the following:

Double-click the **StRC** block in the design workspace.

Right-click the **StRC** block in the design workspace and click **Open**.

Click the **StRC** block in the design workspace and press **Enter**.

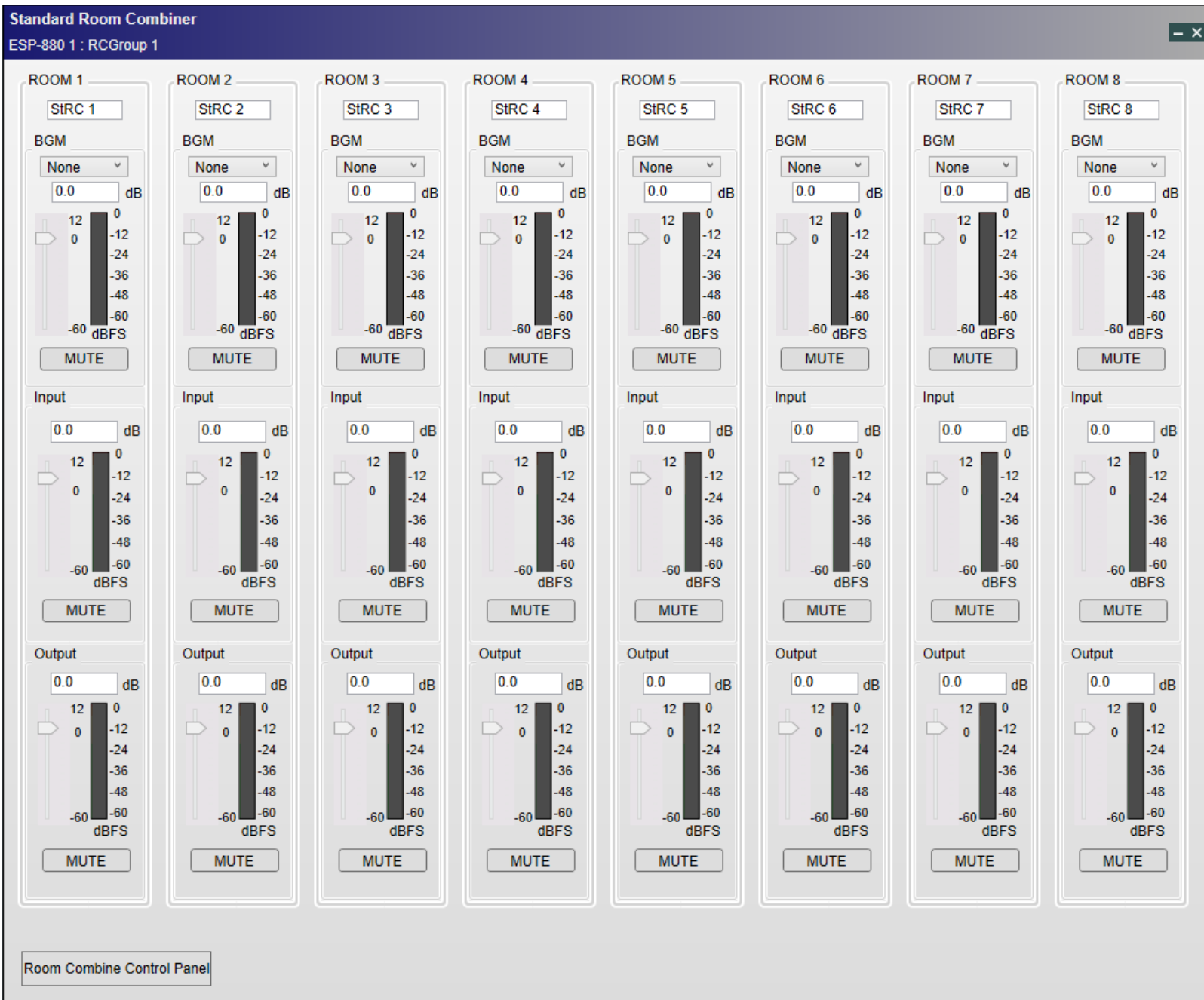

The **Standard Room Combiner** window that will appear includes the following controls:

Room Controls: Each room in the layout can be controlled by a vertical “channel strip” shown in this window. Each channel strip includes the following controls:

Room Label: Shows the name of the room. You can click this field and enter a different name.

BGM: The background music channel (mono).

Source: Sets the source of the background music (BGM). You can select any of the BGM outputs you created for the StRC block or **None** (no music).

Volume Level: Adjusts the output signal level of the background music (BGM). The range of this setting is $-\infty$ dBFS to +12 dBFS.

Mute: Mutes or unmutes the background music (BGM) signal. The button is red while muted and gray while unmuted.

Input: The main input channel (mono).

Volume Level: Adjusts the input signal level of the microphones. The range of this setting is $-\infty$ dBFS to +12 dBFS.

Mute: Mutes or unmutes the input signal. The button is red while muted and gray while unmuted.

Output: The main output channel (mono).

Volume Level: Adjusts the overall output signal level of the room. The range of this setting is $-\infty$ dBFS to +12 dBFS.

Mute: Mutes or unmutes the output signal. The button is red while muted and gray while unmuted.

Scroll Bar: Scrolls across the array of room channel strips. Four room channel strips are visible at a time.

Room Combine Control Panel: Opens the **Room Combine** window. See [Combining Rooms](#) to learn about this.

IMPORTANT: When combining rooms with different settings for the volume level, mute state, and/or BGM source, the combined room will (1) use the lowest volume level, (2) be muted if any of the original rooms is muted, and (3) use the BGM source of the room with the lowest number.

Creating & Editing a Room Layout

You can use the grid in the **Room Combine Layout** window to configure the size and layout of the rooms and combine them with each other.

To open the Room Combine Layout window, click **Edit Room Layout** in the **Room Combine** window.

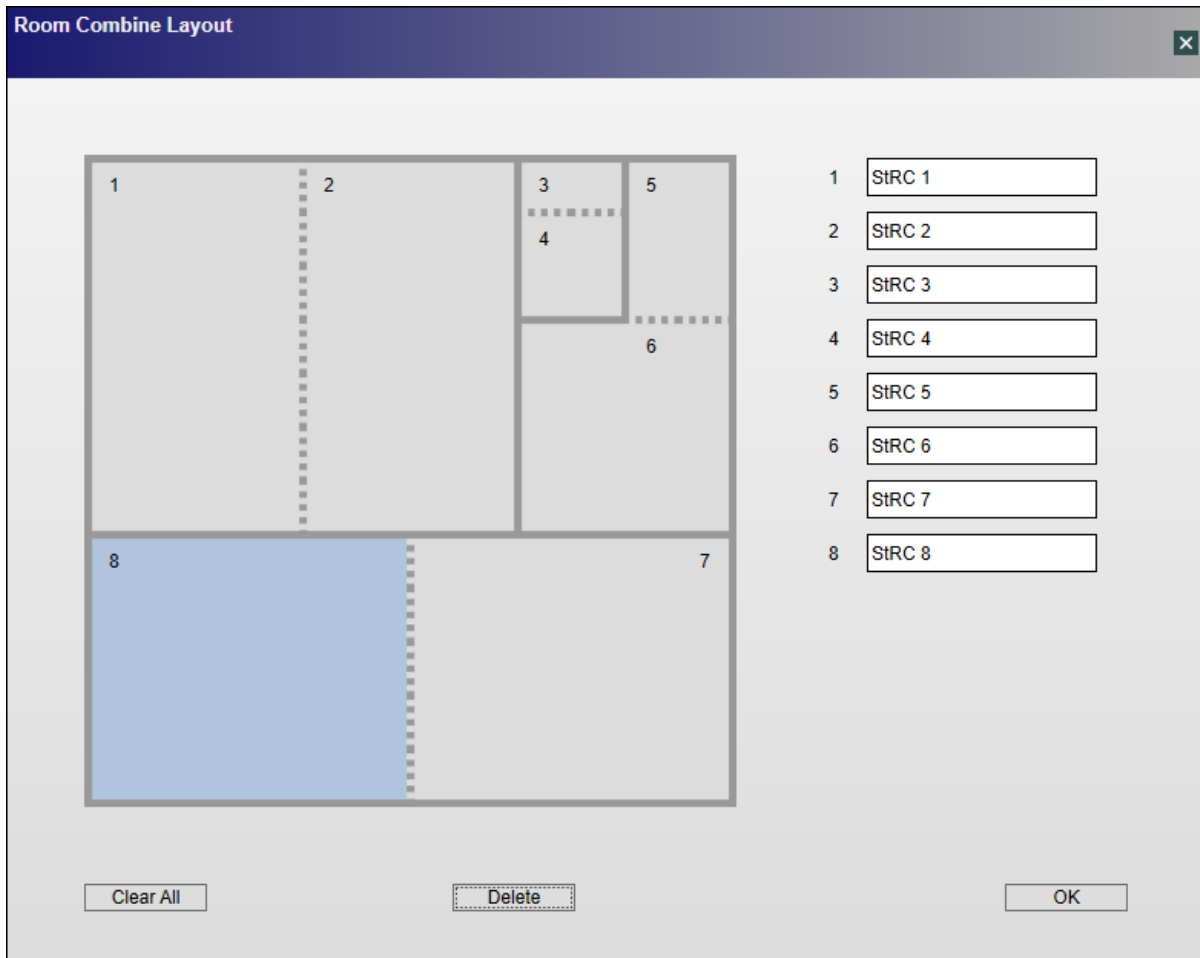

To edit the name of the room, click the room label field and enter a different name.

To assign a number to a room, click an unassigned room square.

To remove a wall, click it. You can create square or rectangular rooms only.

Note: If clicking a wall would create an irregularly shaped room, then more than one wall will be removed (to create a square or rectangular room).

To replace a wall with a partition, click a wall between two numbered rooms. The solid line will change to a dotted line, indicating a partition instead of a standard wall.

To reset the walls and room number assignment of the selected room only, click **Delete**.

To reset all walls and room number assignments, click **Clear All**.

The **Room Combine Layout** window includes the following controls:

Room Grid: This grid is a visual representation of the combined rooms. See the instructions above to learn how to edit the layout.

Room Labels: These are the names of the rooms. You can click each field and enter a different name.

Clear All: Resets all changes you have made to the layout, including the rooms' number assignments.

Delete: Resets the changes you have made to the selected room only, including its number assignment.

OK: Locks the combined room layout.

Combining Rooms

You can use the grid in the **Room Combine** window to combine rooms in the layout with each other.

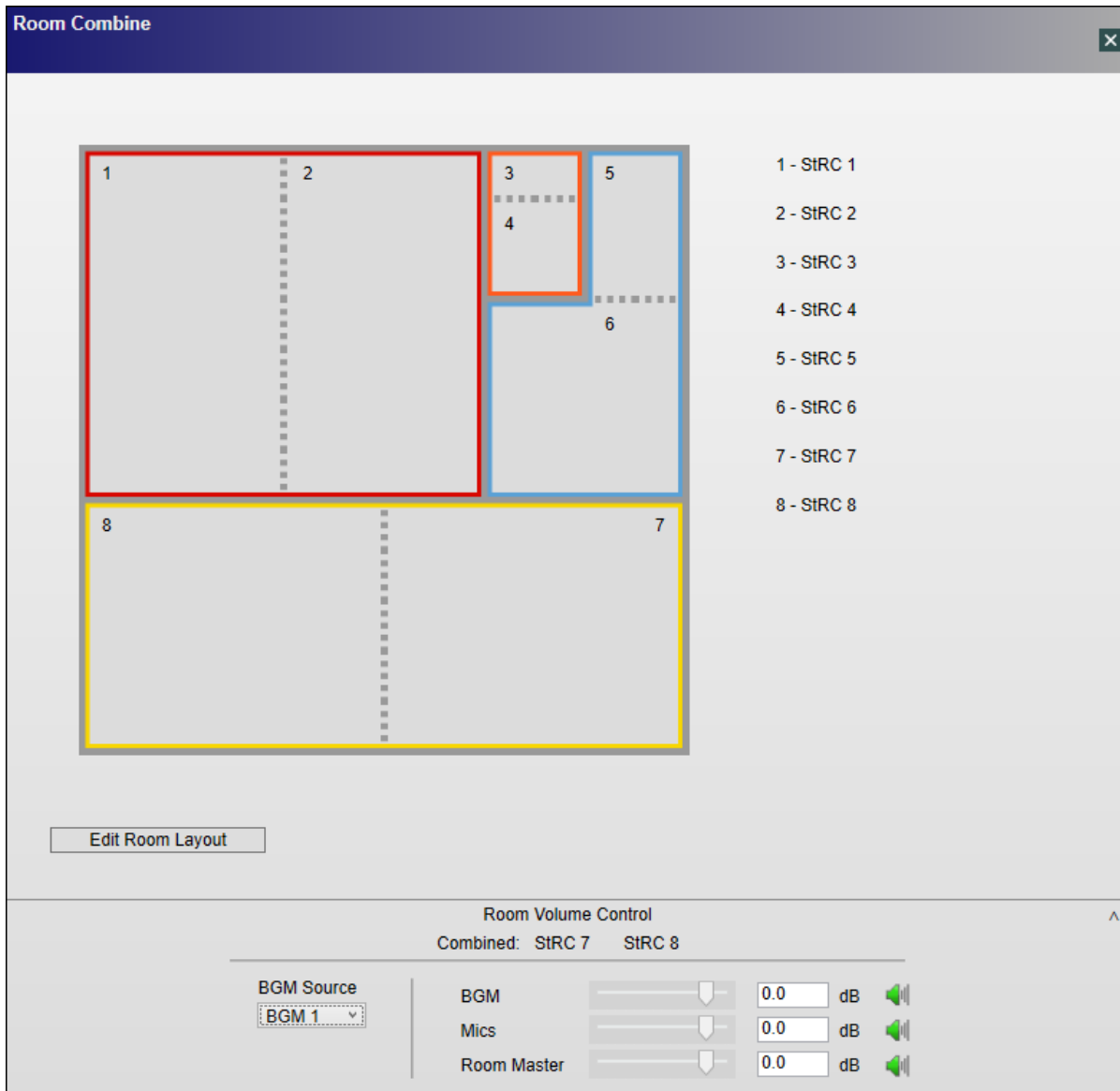

To combine two rooms, click the first one to select it, and then press and hold **Ctrl** while clicking the second room. The two rooms will be outlined by a colored line. You can repeat this process to add more rooms.

To remove a room from a combination, click the one of the rooms in the combination to select it, and then press and hold **Ctrl** while clicking the room you want to remove. The colored outline will disappear. You can repeat this process to remove more rooms from the combination.

While the room layout is locked (i.e., you are unable to edit it), the **Room Combine Layout** window includes the following controls:

Room Grid: This grid is a visual representation of the combined rooms.

Room Labels: The names of the rooms.

Edit Room Layout: Unlocks the combined room layout, allowing you to edit it.

Room Volume Control: Click this tab to collapse or expand it.

Combined: The name of the selected room.

Outputs: The source of the background music (BGM). See [Adjusting Volume & Muting](#) to learn how to change it.

BGM: The output signal level of the background music (BGM). The volume icon is gray while the signal is muted or green while it is unmuted. See [Adjusting Volume & Muting](#) to learn how to change these settings.

Mics: The input signal level of the microphones. The volume icon is gray while the signal is muted or green while it is unmuted. See [Adjusting Volume & Muting](#) to learn how to change these settings.

Room Master: The overall output signal level of the room. The volume icon is gray while the signal is muted or green while it is unmuted. See [Adjusting Volume & Muting](#) to learn how to change these settings.

Speaker PEQ (Bose Speaker Parametric EQ)

The Bose Speaker Parametric EQ is an advanced signal processing block to permit loudspeaker equalization, and bandpass within a single design element.

Double-click on the Speaker EQ block in Signal Processing View to open its control panel.

The screenshot shows the Speaker EQ control panel. On the left, a tree view shows the 'Speaker EQ' block selected, with sub-items: 'Single Speaker', 'MidHigh + Bass', 'Bass Array - 2 Box', 'Bass Array - 4 Box', and 'Speaker PEQ' (circled in red). The main panel is titled 'Speaker PEQ' and 'EX-1280C 1. SpeakerPEQ 1'. It features an 'EQ Preset' section with 'Load Loudspeaker EQ' and 'Save EQ As...' buttons. The 'Driver Alignment' section shows 'Delay (msec)' set to 0.000 and a 'Polarity' dropdown set to 'P (+)'. The 'EQ Stages' section displays a frequency response graph from 20Hz to 20kHz, with a gain of 0.0 dB. The 'Band-pass' section has 'Low' and 'High' filters, both set to '20' and '20000' respectively, with 'Bypass' buttons. The 'Parametric EQ' section has 9 bands, each with 'PEQ', 'FREQ', 'GAIN', and 'Q' controls, and 'Bypass' buttons.

Bose Speaker Parametric EQ, processing block and control panel

The Bose Speaker Parametric EQ control panel provides the following options:

EQ Preset – load or save pre-defined loudspeaker processing values.

Load Loudspeaker EQ – populates control panel with factory-calibrated, pre-defined settings for Bose loudspeakers. Bose loudspeakers are locked when loaded in to the processing block. Use **Save EQ As** to unlock the settings. The original locked preset will remain unchanged.

Save EQ As – allows user to save EQ and loudspeaker settings to an external .SEQ file.

EQ Stages – displays a graphical representation of adjustable EQ filter settings in both frequency and level. The line varies according to values adjustable within the Band-pass and Parametric EQ sections.

Band-pass – determines the low-pass and high-pass filter settings for the loudspeaker processor according to filter type and frequency.

Parametric EQ – provides adjustable controls for defining individual parametric filters. Available options are:

Type – determines the filter parameters used for the EQ. Four types of filters are available to define the filter. Options include:

PEQ – enables parametric EQ filter options for this band.

High Shelf - enables high-frequency shelving filter options for this band.

Low Shelf - enables low-frequency shelving filter options for this band.

Notch - enables notch filter (cut only) options for this band.

FREQ – adjusts the center frequency of the filter via direct entry or the up and down buttons.

GAIN – sets the individual filter gain from -20dB to +20dB.

BW/Q – selects the unit of measure for filter width to Q or Bandwidth (octaves).

Bypass – disables this specific filter from affecting the signal chain.

EQ Gain – provides up to +/-15 dB of output gain adjustment for the Parametric EQ stage. This setting may also be referred to as Make-up Gain.

Driver Alignment – adds a single delay to all loudspeakers connected to this block. This is a read-only parameter for Bose loudspeaker presets.

Signal Polarity Control - Inverts the polarity of the signal. Default value is positive (+) or non-inverted. When selected, the signal polarity is negative (-) or inverted. Button color is used to indicate current state with GREEN = non-inverted and RED = inverted.

Standard Mixer

The Standard Mixer SP block is used to combine (mix) and route input signals to output channels. Gain and mute settings are available for each input and output.

Setting the Number of Ports

To set the number of input and output ports for a Standard Mixer block:

1. Drag the Standard Mixer block into Signal Processing View.
2. In the Standard Mixer dialog, you can select from list of pre-defined port configurations, such as 2x1, 4x1, 8x8, 16x24 and many others. Alternatively, you can select or type in the number of input and output ports (up to 32 each, max) using the Input and Output ports selector controls.

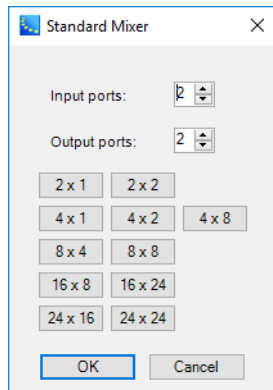

3. Click **OK** to add the block to the Signal Processing View.

You can modify the number of inputs and outputs to a block by right clicking on the block and selecting **Change Channel Count**. You can then modify the number of channels, up to a maximum of 32 inputs or outputs.

Standard Mixer Block and Control Panel

Double-click on the Standard Mixer block in Signal Processing View to open its control panel.

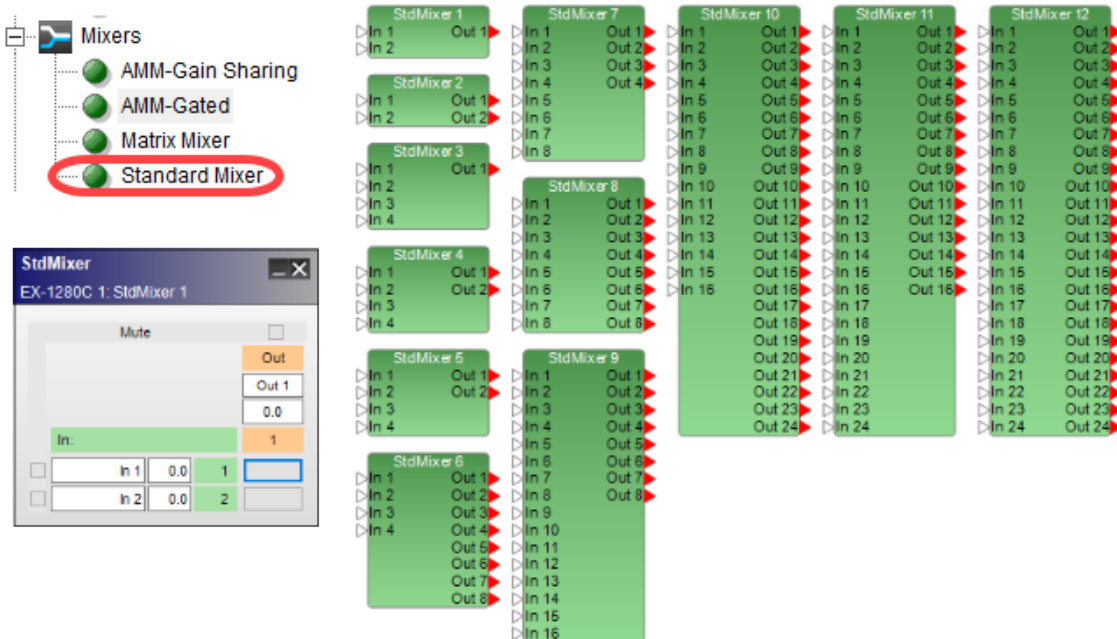

Standard Mixer processing blocks and 2x1 control panel

The **Standard Mixer control panel** provides the following options:

Input and Output Labels– allow direct entry of user-defined labels for inputs or outputs.

Input Level – is a direct entry field for adjusting the input signal. The range of adjustment is from $-\infty$ to +12dB and the input section is shaded in green.

Output Level – is a direct entry field for adjusting the output signal. The range of adjustment is from $-\infty$ to +12dB and the output section is shaded in orange. A level of $-\infty$ may be set by entering a value less than -60.

NOTE: To enable $-\infty$ in a direct entry field without a gain slider, enter any value less than -60dB.

Assign – creates a routing path between an input and an output. Select the assign box at the intersection of the two channels to permit audio to pass from input to output. When an assignment is made, the assign box turns blue.

Mute – silences the signal on a specific input or output and prevents the signal from passing to the next signal processing block in the design. When a Mute box selected, it turns red.

Test/Measurement SP Blocks

The Test/Measurement category of signal processing blocks provides three types of dedicated signal generators:

- Sine Generator
- Noise Generator
- Sweep Generator

Double-click on a block in the Test/Measurement category in Signal Processing View to open its control panel.

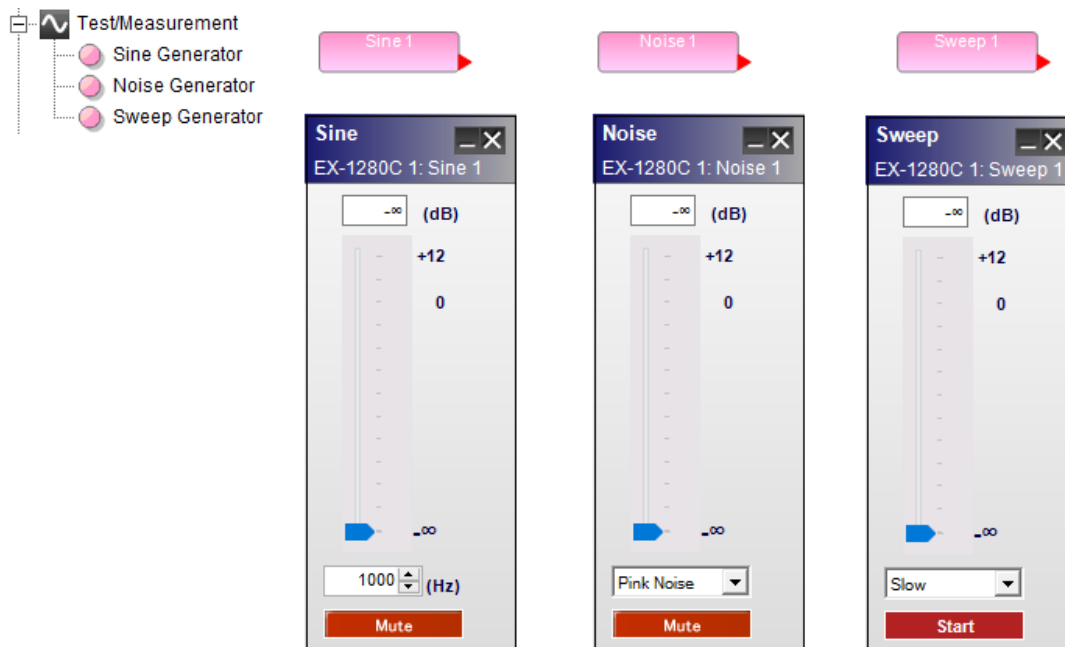

Test/Measurement processing blocks and control panels

The **Test/Measurement processing block control panels** provide the following options:

Sine Generator – outputs a sine wave with variable level and frequency.

Generator Value – permits direct entry of desired output signal level in dB. Range of adjustment matches and tracks the generator gain slider.

Generator Gain Slider – adjusts the output signal level delivered to the next signal processing block. The range of adjustment is from $-\infty$ to +12dB.

Frequency – permits direct entry of desired output frequency in hertz. The range of adjustment is from 20 Hz to 20 kHz.

Mute – silences the signal generator. When Mute is enabled, the control panel button is red (default).

Noise Generator – outputs two types of broadband noise with variable level.

Generator Value – permits direct entry of desired output signal level in dB. Range of adjustment matches and tracks the generator gain slider.

Generator Gain Slider – adjusts the output signal level delivered to the next signal processing block. The range of adjustment is from $-\infty$ to +12dB.

Noise Type – provides a selector to choose between the two available types of noise, Pink noise and White noise.

Mute – silences the signal generator. When Mute is enabled, the control panel button is red (default).

Sweep Generator – outputs a swept sine wave from 20 Hz to 20 kHz with variable level and speed.

Generator Value – permits direct entry of desired output signal level in dB. Range of adjustment matches and tracks the generator gain slider.

Generator Gain Slider – adjusts the output signal level delivered to the next signal processing block. The range of adjustment is from $-\infty$ to +12dB.

Sweep Speed – provides a selector to choose between the two available rates of sweep, Fast or Slow.

Start / Stop – enables or disables the signal generator.

Tone Control EQ

The Tone Control EQ boosts or cuts the output level at the low, mid, and high frequency bandwidths. Double-click on the Tone control EQ block in Signal Processing View to open its control panel.

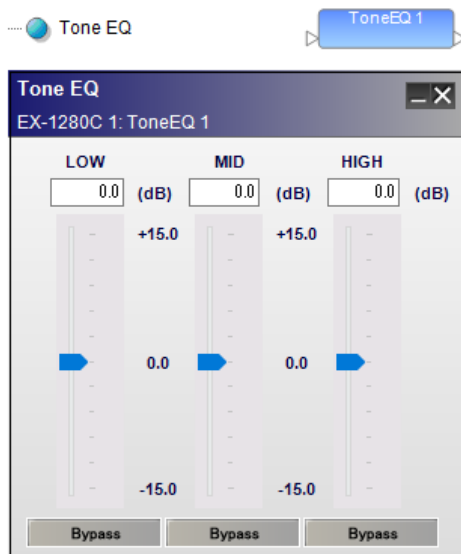

Tone control EQ, processing block and control panel.

The **Tone control EQ control panel** provides the following options:

LOW – controls a 200Hz 6dB per octave shelving filter.

Gain slider – is adjustable to boost or cut the level from -15 dB to +15 dB. Enter a boost or cut value in the input box above this slider to set the gain.

Bypass – disables this specific filter from affecting the signal chain.

MID – controls a 1000Hz, one octave parametric filter. (Q=1.414 or BW=1.0).

Gain slider – is adjustable to boost or cut the level from -15 dB to +15 dB. Enter a boost or cut value in the input box above this slider to set the gain.

Bypass – disables this specific filter from affecting the signal chain.

HIGH – controls a 5000Hz 6dB per octave shelving filter.

Gain slider – is adjustable to boost or cut the level from -15 dB to +15 dB. Enter a boost or cut value in the input box above this slider to set the gain.

Bypass – disables this specific filter from affecting the signal chain.

EX-1280C Processor

EX-1280C Device Properties

The EX-1280C is configured through the Properties panel. To access the EX-1280C properties panel, right-click on the EX-1280C icon in the Project View and select Properties.

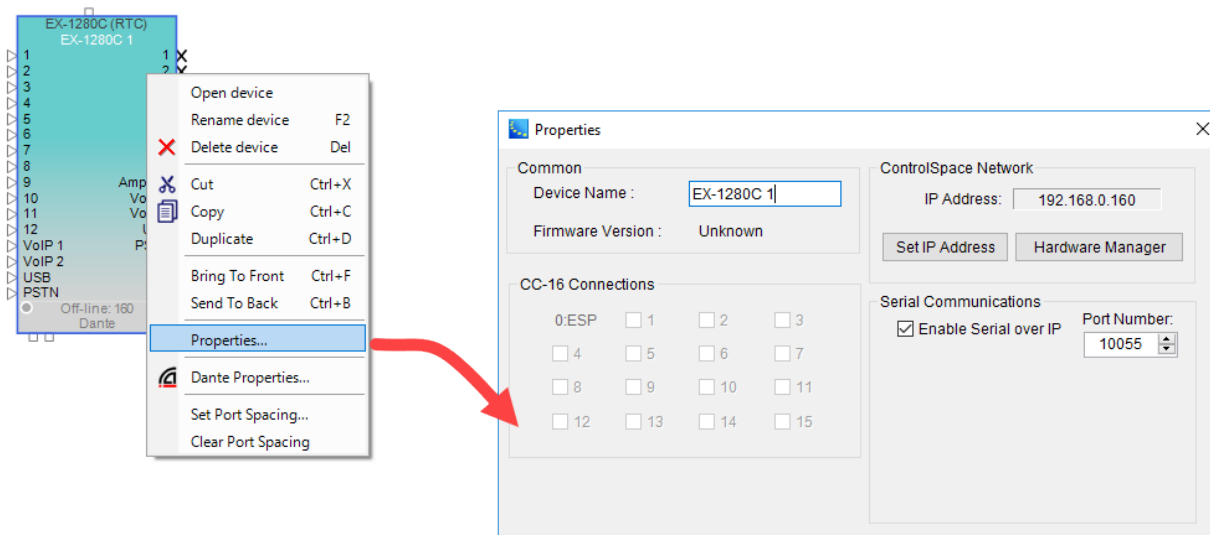

EX-1280C Properties Panel

The Properties panel shows all of the items which determine the configuration of the EX-1280C.

Device Name – the unique name of the EX-1280C that is displayed within the Project View. This unique name is also used in serial protocol programming. The name can be changed by selecting the name and entering a new one.

Firmware Version – displays the current version of the firmware in the EX-1280C. This item is only available when on-line with the EX-1280C.

CC-16 Connections – displays a check mark beside numbers 1 through 15 matching the device ID of each CC-16 connected to the EX-1280C.

ControlSpace Network– displays the current IP address for the ControlSpace Network port. When configured for DHCP, the device address is disabled. When configured for Fixed IP, the device address is enabled. To change the network connection type, the Network Setup control panel must be used.

Set IP Address – clicking this button allows you to change the IP address of the device.

Hardware Manager – clicking this button opens the Hardware Manager dialog. See [Launching the Hardware Manager](#).

Serial Communications - provides serial data settings.

Enable Serial over IP - check the box to enable serial communication over IP.

Port Number - current serial communications port number.

EX-1280C Input/Output Controls

Input Control Panel

Adjustable options may be changed in the control panel for the analog inputs. The control panel can be opened by double clicking on one of the grouped input blocks in Signal Processing View. Each control panel displays the controls for four analog input channels.

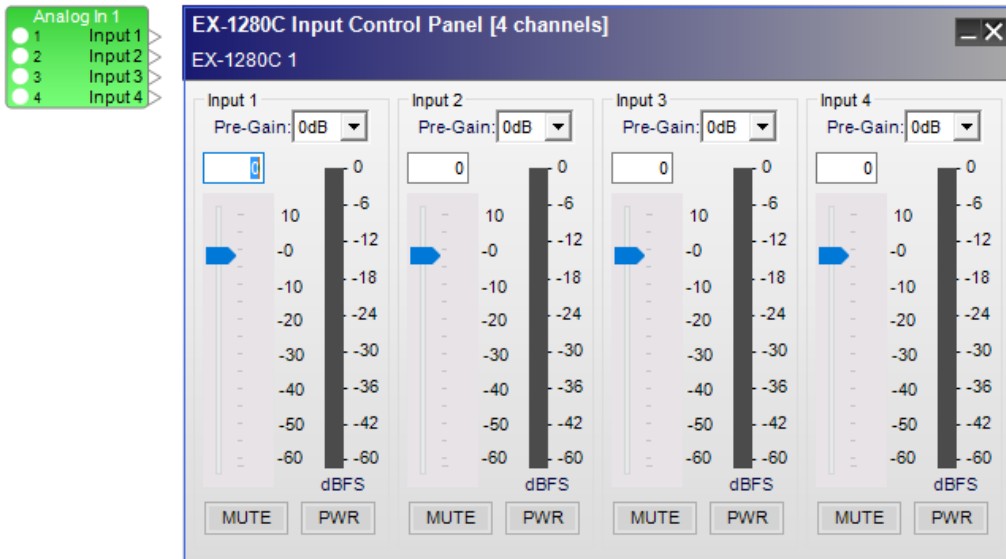

EX-1280C Input Control Panel

The **Input Control Panel** provides the following options:

Input 1-4 Label - Displays the channel name as defined by the user within Signal Processing View. Labels may be changed by highlighting the input block in the Signal Processing View, then using the F2 key, right-click menu, or the Properties window.

Pre-Gain Control - Allows the selection of a pre-defined amount of analog input gain (0, 14, 24, 32, 44, 54, or 64 dB).

Input Level Entry - Permits direct entry of desired input signal level in dB. Range of adjustment matches and tracks the input gain slider.

Input Gain Slider - Adjusts the input signal level delivered to the next signal processing block. The range of adjustment is from $-\infty$ to +12dB. This adjustment point is in the digital domain, post analog to digital conversion.

Input Signal Meter - Displays the current input signal level in dBFS at the input to the next processor function. Input meters include a 'peak hold' indicator which is identified by a red line across the meter.

Mute - Silences the signal and disables audio from passing to the next signal processing block in the design. When Mute is enabled, the control panel button is Red.

PWR - When selected, engages the +48V phantom power.

Output Control Panel

Adjustable options may be changed in the control panel for the analog outputs. The control panel can be opened by double clicking on one of the grouped output blocks in the signal processing view. Each control panel displays the controls for four analog output channels.

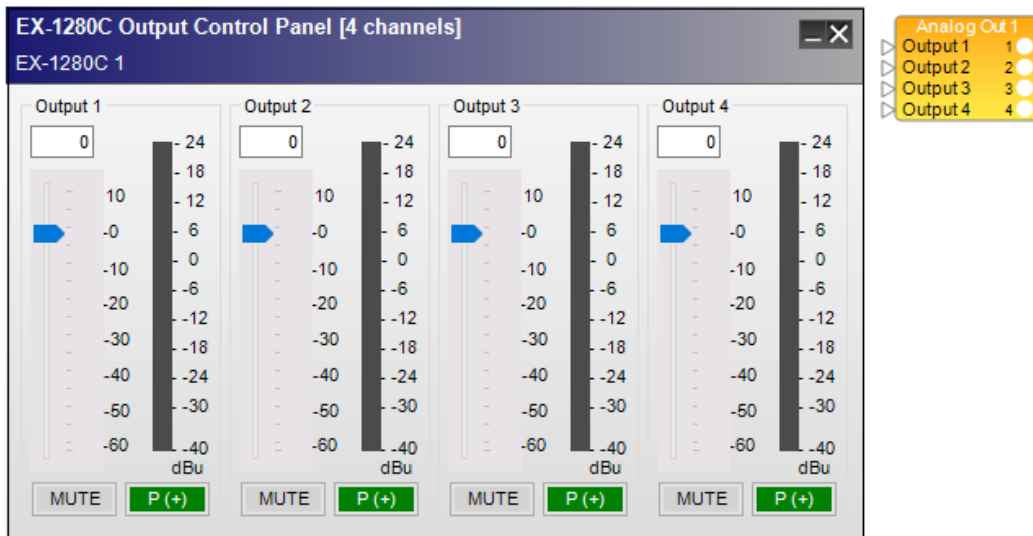

EX-1280C Output Control Panel

The **Output Control Panel** provides the following options:

Output 1-4 Label - Displays the channel name as defined by the user within the Signal Processing View. Labels may be changed by highlighting the input block in Signal Processing View, then using the F2 key, right-click menu, or the Properties window.

Output Level Entry - Allows the direct entry of the amount of attenuation ($-\infty$ dB, min, to +12 dB, max, in increments of 0.5 dB) applied to the output signal.

Output Gain Slider - Adjusts the output signal level delivered to the analog output. The range of adjustment is from $-\infty$ to +12dB.

Output Signal Meter - Displays the current output signal level in dBFS at the input to the next processor function. Output meters include a 'peak hold' indicator which is identified by a red line across the meter.

Mute - Silences the signal and disables audio from passing to the analog output. When **Mute** is enabled, the control panel button is Red.

Signal Polarity Control - Inverts the polarity of the signal. Default value is positive (+) or non-inverted. When selected, the signal polarity is negative (-) or inverted. Button color is used to indicate current state with GREEN being non-inverted and RED being inverted.

EX-1280C AmpLink Output Controls

Adjustable options may be changed in the control panel for the AmpLink outputs. The control panel can be opened by double clicking on the AmpLink output block in Signal Processing View. This control panel displays all eight output channels.

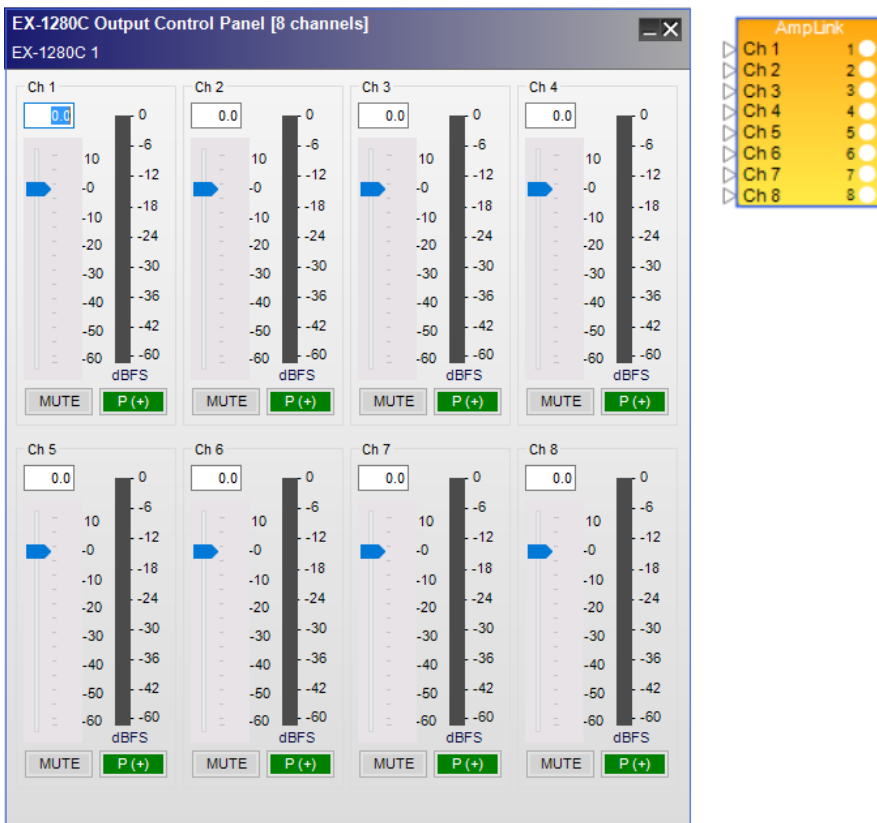

EX-1280C AmpLink Output Control Panel

The **Output Control Panel** provides the following options:

Output Label - displays the channel name. Labels may be changed by highlighting the input block in Signal Processing View, then using the F2 key, right-click menu, or the Properties window.

Digital Output Level Direct Entry - allows the direct entry of the amount of attenuation ($-\infty$ dB, min, to +12 dB, max, in increments of 0.5 dB) applied to the output signal.

Digital Output Gain Slider - allows the adjusting of the amount of attenuation ($-\infty$ dB, min, to +12 dB, max, in increments of 0.5 dB) applied to the output signal.

Output Signal Meter - displays the current output signal level in dBFS at the output of the signal processor. Output meters include a peak hold indicator, which is identified by a red line across the meter.

Mute - when selected, mutes the audio signal at the digital output stage.

Signal Polarity Control - inverts the polarity of the signal. Default value is positive (+) or non-inverted. When selected, the signal polarity is negative (-) or inverted. Button color is used to indicate current state with GREEN = non-inverted and RED = inverted.

EX-1280C GPIO

EX-1280C processors have five General Purpose Control Input (GP In) ports and five Control Output (GP Out) ports. GP In ports are used to connect external hardware such as potentiometers (to control levels or gains) and switches (contact closures) to invoke parameter sets. Functions are assigned to these external controls in the **GP In** control panel.

See [Programming GPIO](#) for general programming examples.

GP In Control Panel

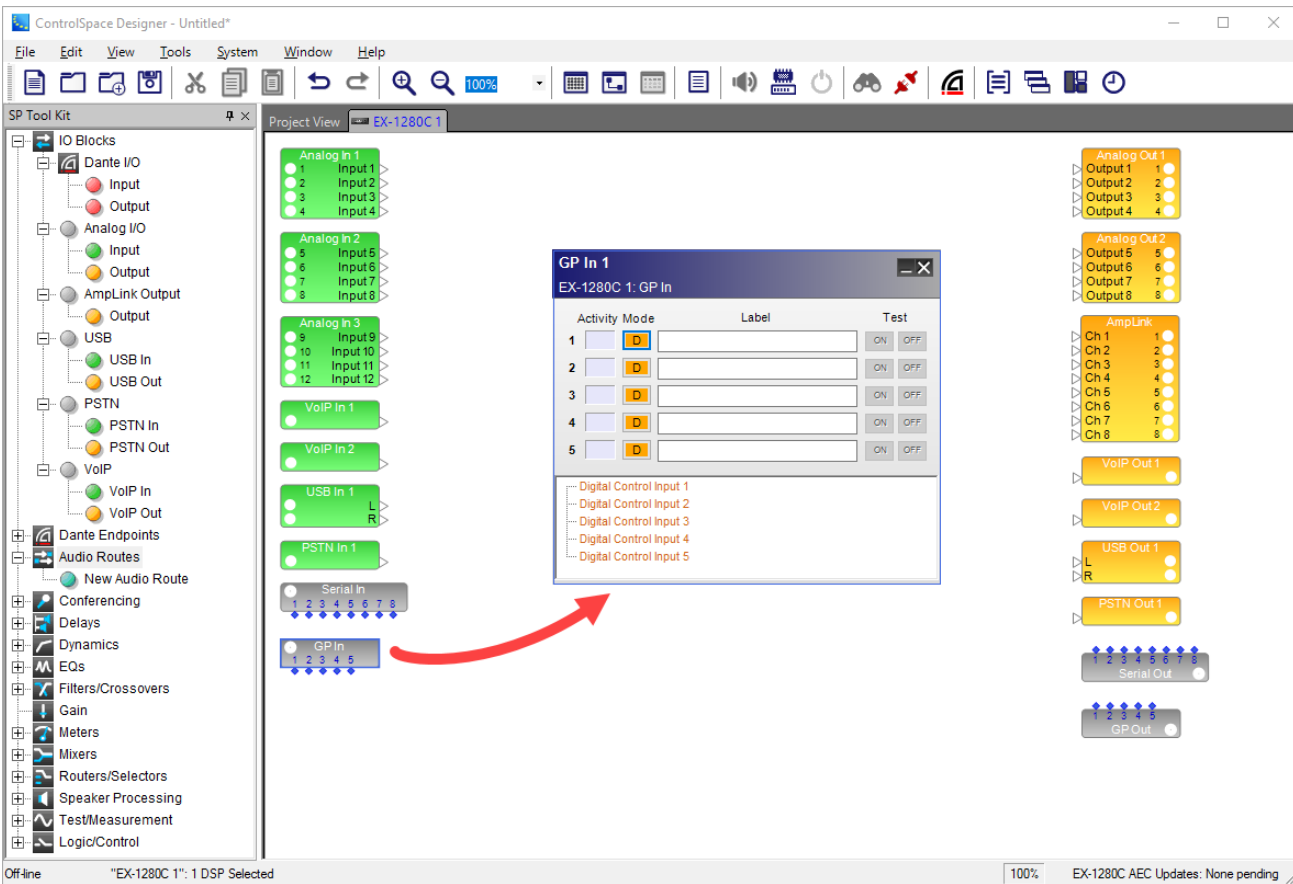

Adjustable input options are accessed by double clicking the appropriate **GP In** block within **Signal Processing View** to open its control panel.





General Purpose Input (GP In) control panel

Activity - indicators notify the user when a GP input is active. Blue indicates an active input, or when a **Test** button is pressed.

Mode buttons– determine the operating mode for each general purpose input. Eight input modes are available within each processing block. Left click the operating mode button to toggle through the three supported modes:

Operating Mode	Description
Digital 	Typically used when connecting a switch or push button, this mode expects a normally open switch for operation. Both “on” and “off” actions are supported.
Up/Down 	Up/Down mode uses two adjacent GPI, and is intended to support two push buttons for use as volume up and down. Normally open switches are expected.
Analog 	Analog mode is intended for a 10K ohm linear type potentiometer that can be linked to a single or group of gain controls. Select A+ if the pot measures 0 ohms when fully <i>counter-clockwise</i> and 10K ohms when fully <i>clockwise</i> . Select A- if the pot measures 0 ohms when fully <i>clockwise</i> and 10K ohms when fully <i>counter-clockwise</i> .

Test buttons - verify programmed actions for each input. Appearance and function of the test buttons change dynamically with each operating mode.

Operating Mode	Test Operation
Digital 	Single left click per test button activates “on” or “off” conditions.
Up/Down 	Single left click per test button activates “up” or “down” conditions.
Analog 	<p>Analog mode is intended for a 10K ohm linear type potentiometer that can be linked to a single or group of gain controls.</p> <p>Select A+ if the pot measures 0 ohms when fully <i>counter-clockwise</i> and 10K ohms when fully <i>clockwise</i>.</p> <p>Select A- if the pot measures 0 ohms when fully <i>clockwise</i> and 10K ohms when fully <i>counter-clockwise</i>.</p>

Labels - are user-definable in the properties window.

The lower section of the control panel provides a programming tree to assign functions invoked by the five General Purpose Inputs. You can drag and drop signal processing blocks, parameter sets, or groups onto the text lines.

GP Out Control Panel

Output functions are accessed by double clicking the appropriate **GP Out** block within **Signal Processing View** to open its control panel.

Buttons 1-5 correspond to the state of each individual general purpose output port. Click a button to set the state of an output to OFF (default) or ON before assigning the GPO processing block in Signal Processing View to a location in the [Project Directory](#) or [Parameter Set Nodes List](#).

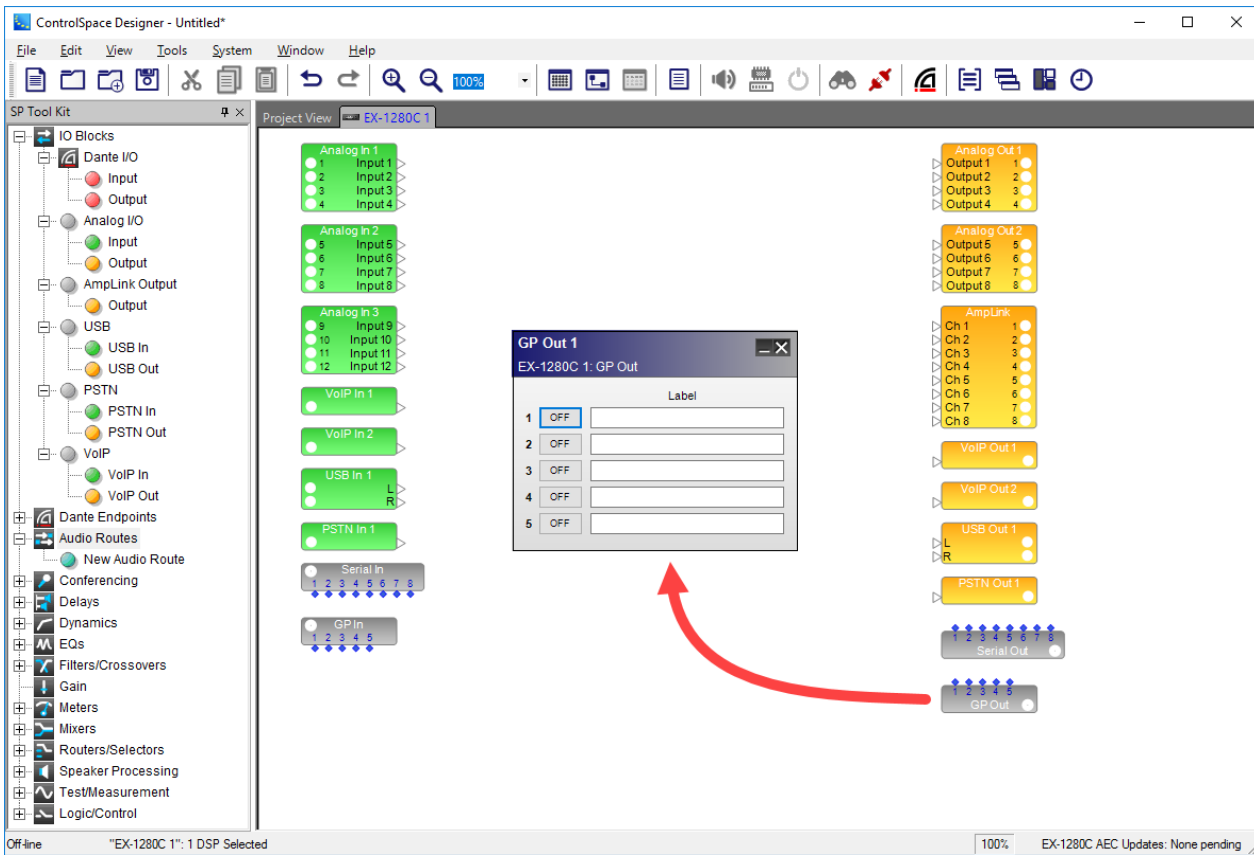

General Purpose Output (GP Out) control panel

EX-1280C Serial Input/Outputs

Serial control support is provided for EX-1280C processors via the rear panel RS-232 serial port or the Ethernet network port. The Serial Input and Serial Output blocks may be used to define custom incoming and outgoing command strings. In addition, signal processing blocks can be directly controlled via external serial commands. An application note with a complete description of the ControlSpace Serial Protocol is available at pro.Bose.com. More information can be found in the [Serial Port Programming](#) topic.

Serial In Control Panel

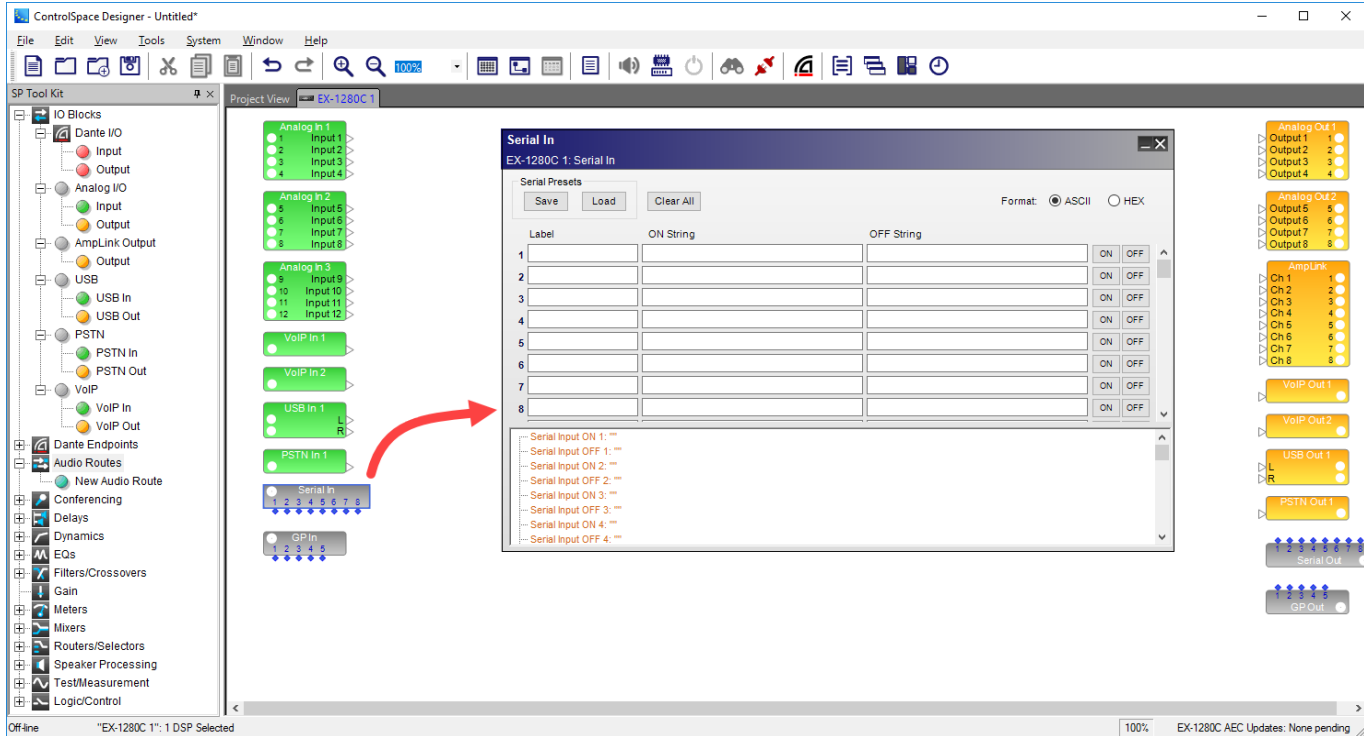

Serial Input processing block and control panel

The Serial Input control panel provides the following options:

Serial Presets - user can create a preset list of serial strings. The preset can then be saved as a separate preset file for future use. Up to 128 total separate incoming serial strings may be defined in a preset. These strings are organized into 64 On/Off pairs to assist in labeling strings which have similar functions.

Save - exports the selected preset to a file at a user-specified location on the computer. The preset file extension is .SPT.

Load - imports a preset file stored on the computer into the Serial In control panel. Loading a serial preset file clears and overwrites all labels and string definitions currently in the Serial In control panel.

Clear All - deletes all labels and string definitions in the Serial In control panel.

Label - assigns a name to the pair of serial strings. This is for reference only.

ON String/OFF String - locations to define serial strings with up to 64 ASCII characters or 64 HEX characters. Matching strings received within the serial data stream from external devices will recall or initiate actions specified in the Serial In programming tree.

Format:

ASCII/HEX - radio buttons determine the unit notation for text entry. Select ASCII for traditional alphanumeric character entry or HEX to convert notation to two bytes per character.

ON/OFF - buttons test the programming functionality of strings defined in the ON String and OFF String fields. Most ControlSpace programming functions for incoming serial strings may be tested offline.

Serial Input Programming Tree - provides a drag-and-drop area for assigning ControlSpace functionality to be performed when matching serial strings are received.

NOTE: ControlSpace EX-1280C processors automatically assume each incoming serial string terminates with a single carriage return (CR). The sending equipment must separate commands by ending the serial

string with a carriage return (CR). It is unnecessary to include this carriage return in the ON/OFF string fields in the Serial Input control panel.

Serial Out Control Panel

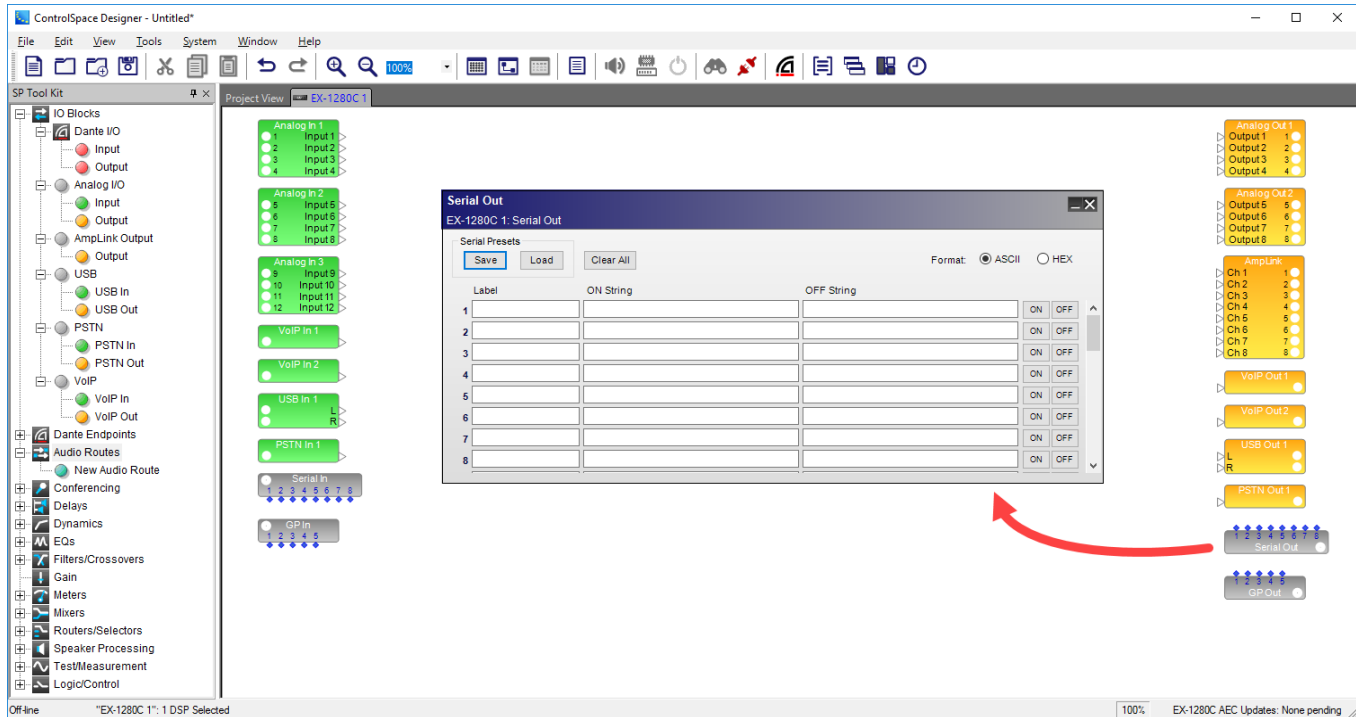

Serial output processing block and control panel

The **Serial Output control panel** provides the following options:

Serial Presets - user can create a preset list of serial strings. The preset can then be saved as a separate preset file for future use. Up to 64 total separate outgoing serial strings may be defined in a preset. These strings are organized into 32 On/Off pairs to assist in labeling strings which have similar functions.

Save - exports the selected preset to a file at a user-specified location on the computer. The preset file extension is .SPT.

Load - imports a preset file stored on the computer into the Serial Out control panel. Loading a serial preset file clears and overwrites all labels and string definitions currently in the Serial Out control panel.

Clear All - deletes all labels and string definitions in the Serial Out control panel.

Label - assigns a name to the pair of serial strings. This is for reference only.

ON String / OFF String - Locations to store up to 64 ASCII characters or 64 HEX characters to be sent to external devices via the RS-232 serial port or the Ethernet port. Parameter sets, GPI inputs, and logic functions can be used to initiate the transmission of the serial strings defined in the Serial In control panel.

Format:

ASCII/HEX- radio buttons determine the unit notation for text entry. Select ASCII for traditional alphanumeric character entry or HEX to convert notation to two bytes per character.

ON/OFF - When the processor is online, the ON/OFF test buttons may be used to send the serial strings via the RS-232 or Ethernet ports. No actions or transmissions are made when the processor is offline.

NOTE: Unlike serial input strings, control characters, such as carriage returns or line feeds, are neither assumed nor automatically included when entering serial output strings. When entering output ASCII strings, control characters such as carriage return (CR) and line feed (LF) must be entered in hexadecimal notation. Backslash “\” is used to designate the next two characters as hex. For example, “\0D” would indicate a carriage return and “\0A” would indicate a line feed.

Refer to the protocol documents of any third-party devices to find the appropriate serial strings and syntax.

EX-1280C VoIP Input/Outputs

The EX-1280C processor supports up to two single-port Voice Over IP Input (VoIP In) blocks and two single-port VoIP Output (VoIP Out) blocks. The VoIP blocks are used to control the signal level and other parameters of VoIP systems, such as VoIP telephony equipment, that are connected to EX-1280C processors.

VoIP In Control Panel

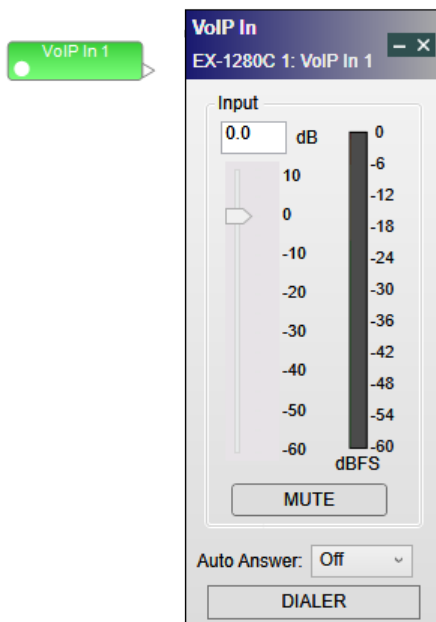

VoIP Input control panel

The **Input Control Panel** provides the following options:

Input Gain Direct Entry - allows the direct entry of gain ($-\infty$ dB, min, to +12 dB, max, in increments of 0.5 dB) applied to the input signal. Range of adjustment matches and tracks the input gain slider.

Input Gain Slider - same purpose as Input Gain Numeric Entry, but provides an alternative way to set the value through use of a gain slider control.

Input Signal Meter - displays the current signal level in dBFS at the input to the EX-1280C. Input meters include a peak hold indicator, which is identified by a red line across the meter.

MUTE - when selected, mutes the audio signal at the input stage.

Auto Answer - sets the number of rings before incoming calls are automatically answered. To disable auto-answering function, select **Off**.

DIALER - accesses the VoIP dialer.

VoIP Out Control Panel

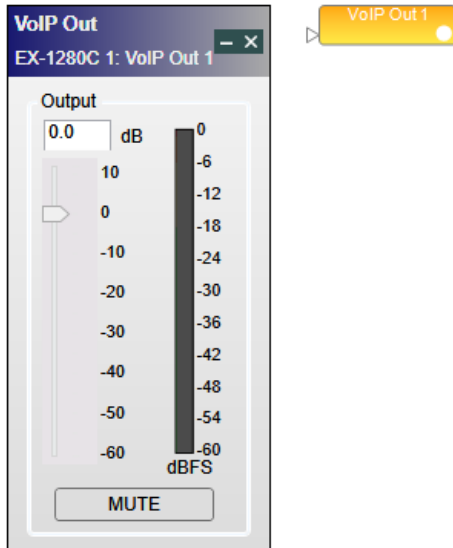

VoIP Output control panel

The **Output Control Panel** provides the following options:

Output Gain Direct Entry - allows the direct entry of gain or attenuation ($-\infty$ dB, min, to +12 dB, max, in increments of 0.5 dB) applied to the output signal. Range of adjustment matches and tracks the output gain slider.

Output Gain Slider - same purpose as Output Gain Direct Entry, but provides an alternative way to set the value through use of a output gain slider control.

Output Signal Meter - displays the current signal level in dBFS at the output from the EX-1280C. Output meters include a peak hold indicator, which is identified by a red line across the meter.

Mute - when selected, mutes the audio signal at the output stage.

VoIP Dialer

To access the dialer, click **DIALER** in a VoIP In SP block, or right click on the VoIP In block and select **Open VoIP Dialer**.

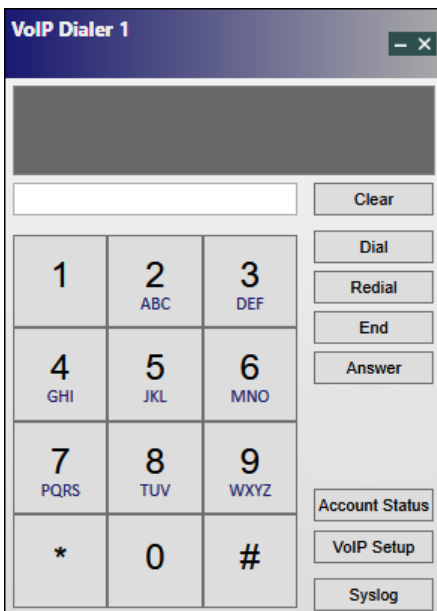

VoIP dialer

To set up just the basic the IP addressing scheme or VLAN for VoIP, see [Managing VoIP](#).

To manage all VoIP and SIP 2.0 settings including the IP address via a web-based application, click **VoIP Setup** and enter "admin" for both login and password when prompted. This default login/password can be changed in the VoIP settings web application. For more information on how to use the VoIP settings web app, refer to the *VoIP Web Interface User Guide* at pro.bose.com.

NOTE: Instead of clicking VoIP Setup to access the VoIP settings web app, you can enter the IP address of your EX-1280C sound processor in the browser and press Enter to display the login and password window.

EX-1280C Dante™ Input/Outputs

The EX-1280C processor supports up to 64 x 64 channels of high quality, uncompressed digital audio from a Dante digital audio network. Dante network functionality is built into the EX-1280C and does not require installation of a Dante network card. These generic Dante I/O blocks can be used whenever simplified routing of any device's audio source(s) between other signal processors and/or Dante-enabled devices is needed.

Setting the Number of Channels

To set the number of channels for a Dante input or output block:

1. From the IO Blocks category in the SP Tool Kit, drag the Dante input or output block into Signal Processing View.
2. In the Select Channels dialog, use Ctrl-Click to select each channel to be included in the block or click and drag to select contiguous channels. You can also check or clear the **Select All** option to select/deselect all of the channels available in the card. The channel counter displays the number of channels selected (you may not use the counter to change or select channels, however).

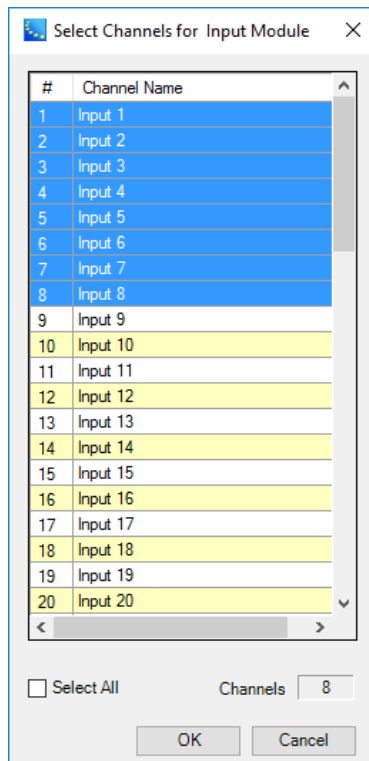

Select Channels dialog

3. Click **OK**.

The Dante input or output block is now added to the view.

Dante Input Control Panel

To access the Dante input controls, double click the appropriate Dante input block in Signal Processing View.

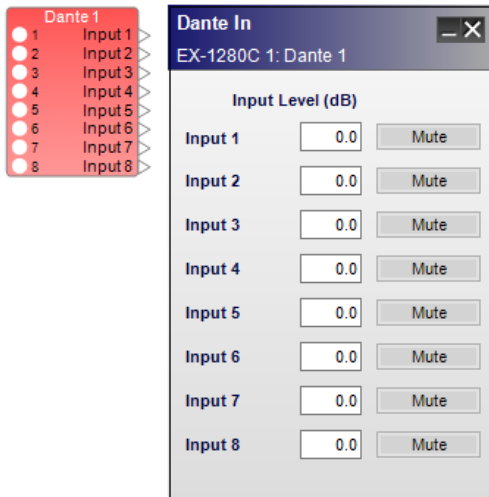

Eight-channel Dante input control panel

Each Dante input control panel provides the following controls:

Input Level (dB) – adjusts the input signal level delivered to the next signal processing block. The range of adjustment is from $-\infty$ to +12dB. Type a value directly into the input level box or right-click the field to access a gain slider.

Mute – silences the signal and disables audio from passing to the Dante audio network. When Mute is enabled, the control panel button is Red.

Dante Output Control Panel

To access the Dante output controls, double click the appropriate Dante output block in Signal Processing View.

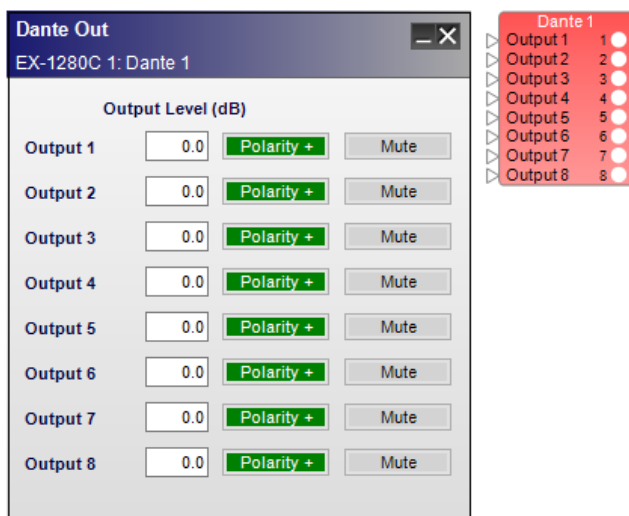

Eight-channel Dante output control panel

Each Dante output control panel provides the following controls:

Output Level (dB) - adjusts the output signal level delivered to the Dante audio network. The range of adjustment is from $-\infty$ to +12dB. Type a value directly into the output level box or right click the field to access a gain slider.

Polarity - inverts polarity of the output signal. When Polarity is normal, the control panel button is Green and a plus (+) sign is present. When Polarity is inverted, the control panel button is Red and a minus (-) sign is present.

Mute - silences the signal and disables audio from passing to the Dante audio network. When Mute is enabled, the control panel button is Red.

NOTE: For more information on configuring Bose professional system electronics for use with Dante digital audio network audio, refer to the Dante application notes available at pro.Bose.com.

EX-1280C PSTN Input/Outputs

The EX-1280C processor supports one single-port PSTN (Public Switched Telephone Network) Input block (PSTN In) and one single-port PSTN Output block (PSTN Out). The PSTN block is used to control the signal level and other parameters of PSTN equipment, such as POTS (Plain Old Telephone Service)/analog telephones, used with EX-1280C processors.

PSTN In Control Panel

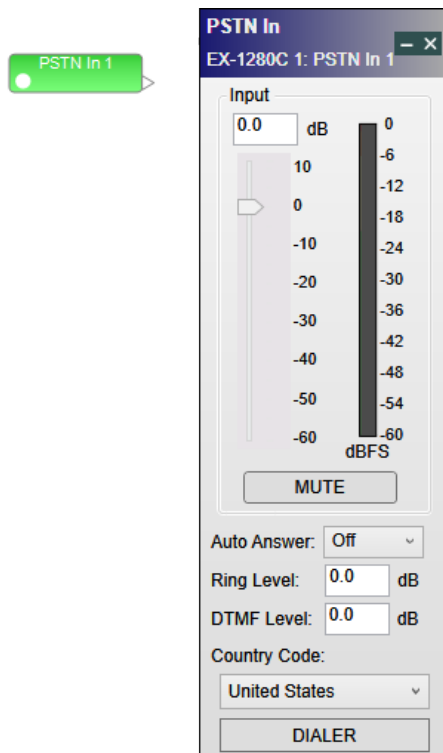

PSTN Input control panel

The **Input Control Panel** provides the following options:

Input Gain Direct Entry - allows the direct entry of gain ($-\infty$ dB, min, to +12 dB, max, in increments of 0.5 dB) applied to the far-end input signal. Range of adjustment matches and tracks the input gain slider.

Input Gain Slider - same purpose as Input Gain Direct Entry, but provides an alternative way to set the value through use of a gain slider control.

Input Signal Meter - displays the current signal level in dBFS at the input to the EX-1280C. Input meters include a peak hold indicator, which is identified by a red line across the meter.

Mute - when selected, mutes the audio signal at the input stage.

Auto Answer - sets the number of rings before incoming calls are automatically answered. To disable auto-answering function, select OFF.

Ring Level - sets audio level in dB of ring tone for incoming calls.

DTMF - sets audio level in dB of DTMF (touch tone keypad) tones heard in local room.

County Code - sets the country code.

DIALER - accesses the PSTN dialer.

PSTN Out Control Panel

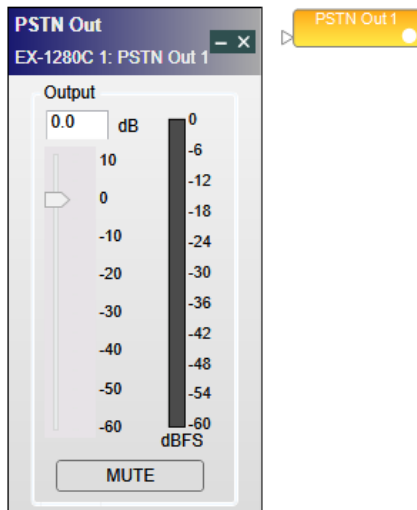

PSTN Output control panel

The **Output Control Panel** provides the following options:

Output Gain Direct Entry - allows the direct entry of gain or attenuation ($-\infty$ dB, min, to +12 dB, max, in increments of 0.5 dB) applied to the output signal. Range of adjustment matches and tracks the output gain slider.

Output Gain Slider - same purpose as Output Gain Direct Entry, but provides an alternative way to set the value through use of a output gain slider control.

Output Signal Meter - displays the current signal level in dBFS at the output from the EX-1280C. Output meters include a peak hold indicator, which is identified by a red line across the meter.

Mute - when selected, mutes the audio signal at the output stage.

PSTN Dialer

To access the dialer, click **DIALER** in a PSTN In SP block, or right-click on the block and select **Open PSTN Dialer**.

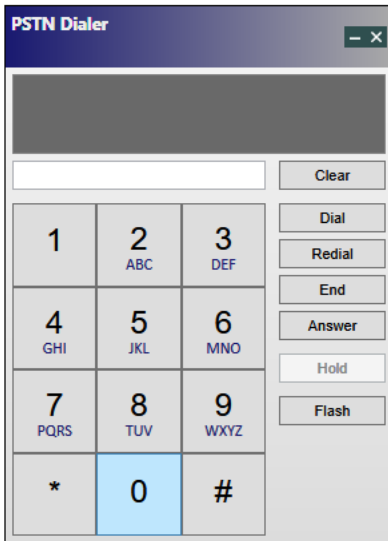

PSTN Dialer

EX-1280C USB Input/Outputs

The EX-1280C processor supports one stereo channel USB Input (USB In) block and one stereo channel USB Output (USB Out) block. The USB block is used to control the signal level and other parameters from soft codecs in PCs, tablets, and laptops used with EX-1280C processors.

NOTE: Soft codecs enable conferencing or other applications (e.g. Skype) via a web browser, downloadable software application, or a combination of these.

USB In Control Panel

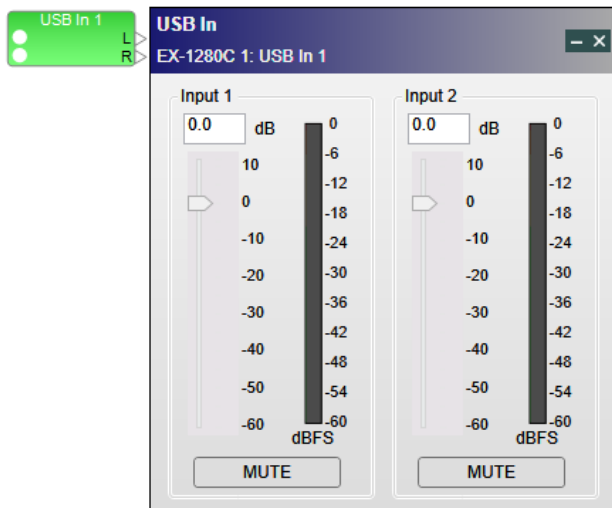

USB Input control panel

The **Input Control Panel** provides the following options:

Input Gain Direct Entry - allows the direct entry of gain ($-\infty$ dB min to +12 dB max, in increments of 0.5 dB) applied to the input signal. Range of adjustment matches and tracks the input gain slider.

Input Gain Slider - same purpose as Input Gain Direct Entry, but provides an alternative way to set the value through use of a gain slider control.

Input Signal Meter - displays the current signal level in dBFS at the input to the EX-1280C. Input meters include a peak hold indicator, which is identified by a red line across the meter.

Mute - when selected, mutes the audio signal at the input stage.

USB Out Control Panel

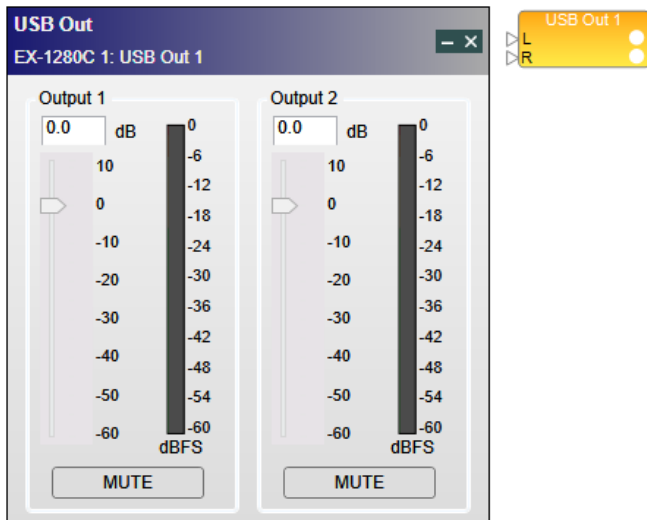

USB Output control panel

The **Output Control Panel** provides the following options:

Output Gain Direct Entry - allows the direct entry of gain or attenuation ($-\infty$ dB min to +12 dB max, in increments of 0.5 dB) applied to the output signal. Range of adjustment matches and tracks the output gain slider.

Output Gain Slider - same purpose as Output Gain Direct Entry, but provides an alternative way to set the value through use of a output gain slider control.

Output Signal Meter - displays the current signal level in dBFS at the output from the EX. Output meters include a peak hold indicator, which is identified by a red line across the meter.

Mute - when selected, mutes the audio signal at the output stage.

EX-1280C Signal Processing

SP Tool Kit

The **Signal Processing (SP) Tool Kit** contains all the signal processing blocks available for use in system designs. The **SP Tool Kit** panel is visible when you are working in Signal Processing View. To add signal processing functions, use the mouse to drag a block from the SP Tool Kit panel and drop it into the applicable Device tab in Signal Processing View.

Signal processing blocks in the SP Tool Kit are categorized by type. Click the "+" next to a group in the SP Tool Kit to expand the group and view its signal processing blocks. To open the control panel for any signal processing block, double-click on the block after you have added it to the applicable Device tab in Signal Processing View.

ESP Signal Processing View

The screenshot displays the ControlSpace Designer interface for the ESP-1240 1 project. The SP Tool Kit on the left lists various signal processing blocks. Two blocks are highlighted with red circles and red arrows pointing to their respective positions in the main workspace: 'Standard Mixer' under the Mixers category and 'MidHigh + Bass' under the Speaker Processing category. The main workspace shows a signal flow starting from 12 inputs (Input 1 to Input 12), passing through a 'StdMixer 1' block, then through an 'M32+MB(Default) SpEQ2Way 1' block, resulting in 4 outputs (Output 1 to Output 4), an 'ESPLink 1' block with 8 channels, and 'Serial Out' and 'GP Out' blocks. The status bar at the bottom indicates the system is offline, the project is 'ESP-1240 1', 1 DSP is selected, the zoom is at 100%, and there are no pending AEC updates for EX-1280C.

Adding signal processing block to ESP Signal Processing View from SP Tool Kit

EX-1280C Signal Processing View

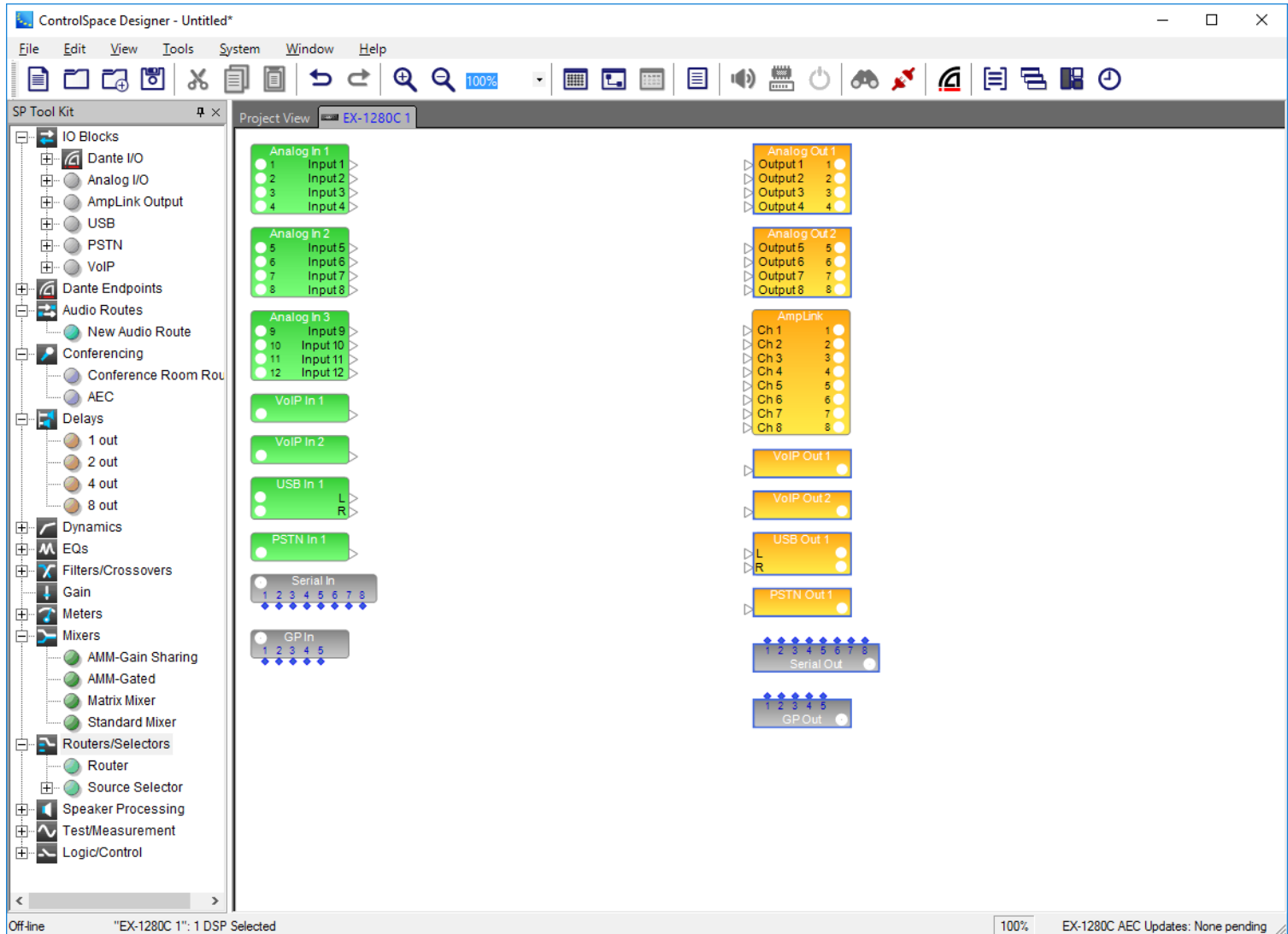

SP Tool Kit for EX-1280C Signal Processing View

Working With SP Blocks

After dropping signal processing blocks into Signal Processing View, you can move one or more blocks by selecting and dragging with the mouse, or by using the arrow keys on your keyboard to nudge the blocks into position. Multiple blocks or items may be selected by using the mouse to drag a selection box around the target items.

Aligning Blocks

To align blocks, use the options in the **Edit menu**. For example, to vertically align the left borders of a group of blocks, select all the blocks and choose **Edit > Align Left Sides**.

NOTE: See the [Edit Menu](#) for additional alignment options.

Wiring Blocks

The output ports of signal processing blocks may be wired to multiple inputs on other devices. Conversely, each input port on a signal processing block may only be connected to one output port on another

processing block.

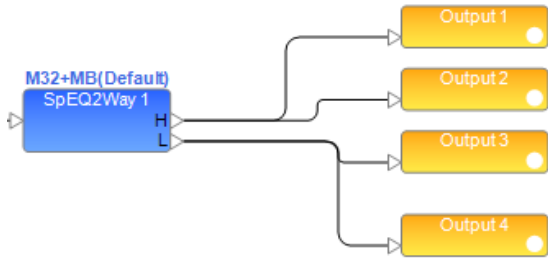

Wiring signal processing blocks

Other SP Block and Wiring Operations

For more information on SP block wiring operations, see [Wiring Operations](#).

For more information on SP block-handling functions, see [Block-Handling Functions](#).

Changing Channel Counts on Blocks

The audio channel count on many SP blocks may be modified after they have been added to a device in the Signal Processing View. This option is only available when the device is offline. In the right-click menu, select **Change Channel Count** to change the audio channel count.

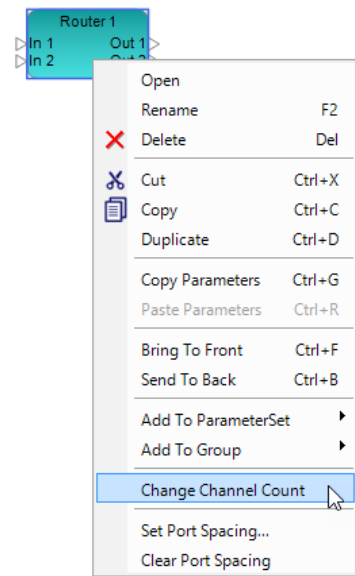

If a block's channel count is modified, the block will be removed from any programming (parameter sets, groups, and timers). If an affected block is in programming when you attempt to re-size it, you will be warned before completing the action. From here, you may click **OK** to continue with modification of the block, or back out of it by clicking **Cancel**.

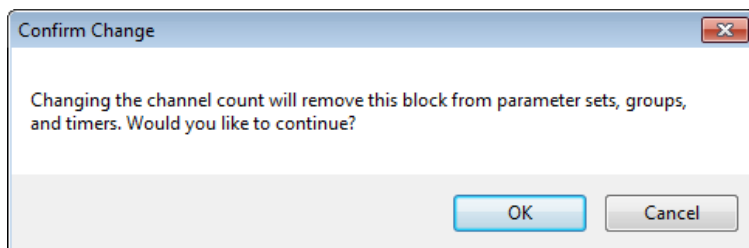

Changing Mixer Channel Input and Output Labels

Input and output channels in Standard Mixers and Matrix Mixers can be given custom labels. These can be edited by double-clicking the block and using the mixer's control panel. The labels are located at the left (input) and top (output) of the form.

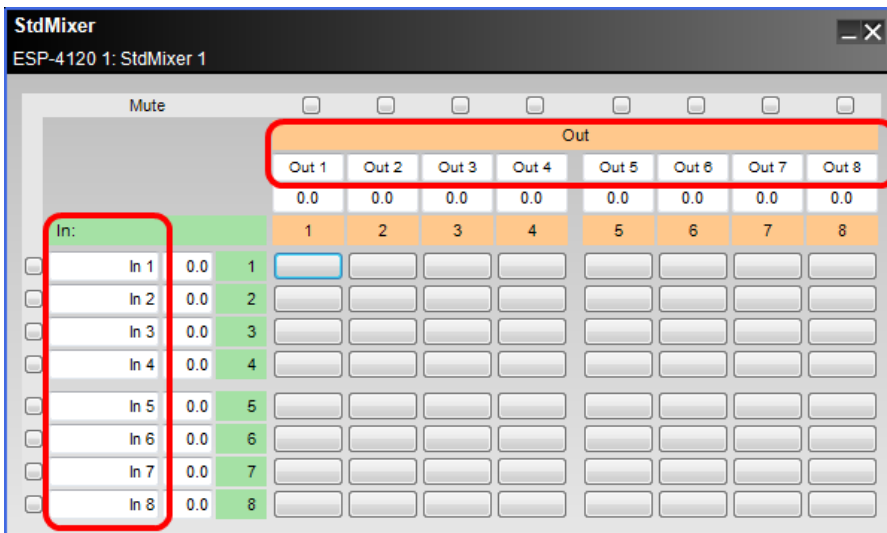

Managing VoIP

The EX-1280C sound processor supports VoIP functionality. You can use CSD's Hardware Manager for the basic VoIP IP addressing setup.

NOTE: For access to all VoIP setup options, use the web-based VoIP application described later in this topic.

From CSD

To set up the basic IP addressing scheme or VLAN on the EX-1280C in CSD for the outgoing VoIP network:

1. Select **Hardware Manager** from the System menu.
2. In the Hardware Manager Device List, select the check box next to the EX-1280C to open the Device Update panel.

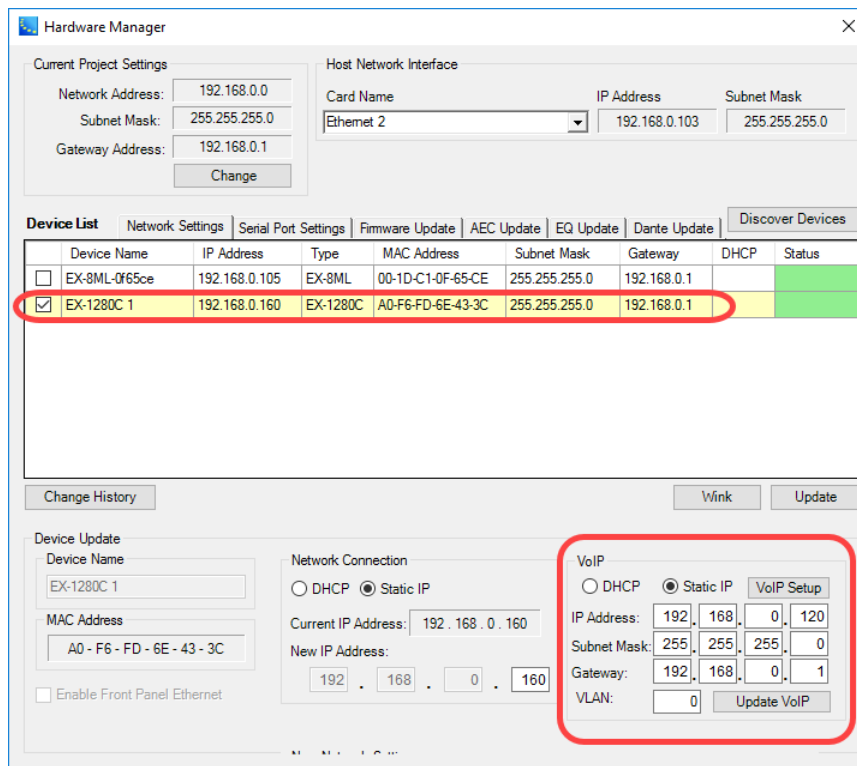

VoIP setup in Device Update panel

- In the VoIP section, designate whether the IP address is assigned via **DHCP** or is **Static**. If Static, enter the IP, Subnet Mask, and Gateway addresses.

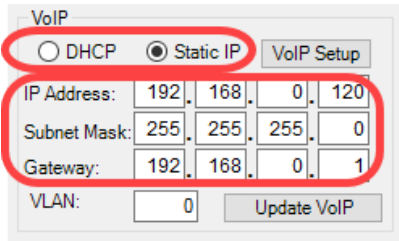

Static IP setup

- If appropriate, designate the VLAN ID number.
- Click **Update VoIP** to save the settings.

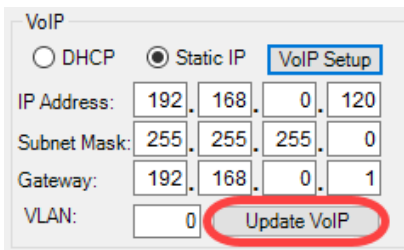

Update to save VoIP settings

- When prompted, click **Yes** to reboot the EX-1280C and complete VoIP setup.

From the Web-Based VoIP Application

To manage either basic or advanced VoIP and SIP 2.0 settings including the IP address and VLAN, access the VoIP web-based application:

1. In Signal Processing View for the EX-1280C, right-click an input VoIP SP block and select **Open VoIP Dialer**.

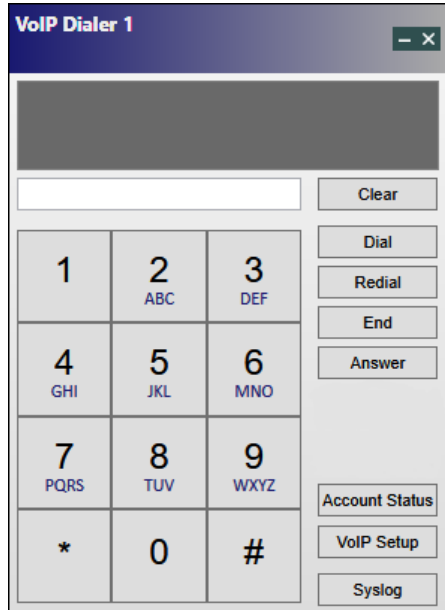

VoIP Dialer

2. Click **VoIP Setup** and enter "admin" for both login and password when prompted in your web browser. This default login/password can be changed in the VoIP settings web application. For more information on how to use the VoIP settings web app, refer to the *VoIP Web Interface User Guide* at pro.bose.com.

You can also access the web app:

- From Hardware Manager by selecting the EX-1280C in the Device list and clicking **VoIP Setup** in the VoIP section of the Device Update panel
- By entering the IP address of your EX-1280C sound processor in the browser and pressing **Enter** to display the login and password window in the web app

Managing Dante Audio Routes

Dante audio routes provide a simple and effective way to send and receive audio signals between multiple EX-1280C processors within your system. These can be discrete audio channels, audio mixes, or any combination of audio signals.

Dante audio routes are set up with Dante input and output blocks. These blocks are paired together within CSD by dragging and dropping them into Signal Processing View in each EX-1280C processor.

Adding Dante I/O Blocks to Set Up an Audio Route

Dante audio routes consist of output and input pairs. Once you drag a Dante output block to the Signal Processing View of an EX-1280C, a corresponding Dante audio route input block is automatically listed in the SP Tool Kit(s) of any other EX-1280C processors in the system.

NOTE: For more on how to add Dante input or output blocks to Signal Processing View, see [EX-1280C Dante™ Input/Outputs](#).

In the following system, there are two EX-1280Cs (named Unit 1 and Unit 2). In the Signal Processing View of each processor, the user has dragged and dropped a Dante output block. In each processor's SP Tool Kit, the Dante audio route input block to the other processor (Input via Unit n in this example) is now listed.

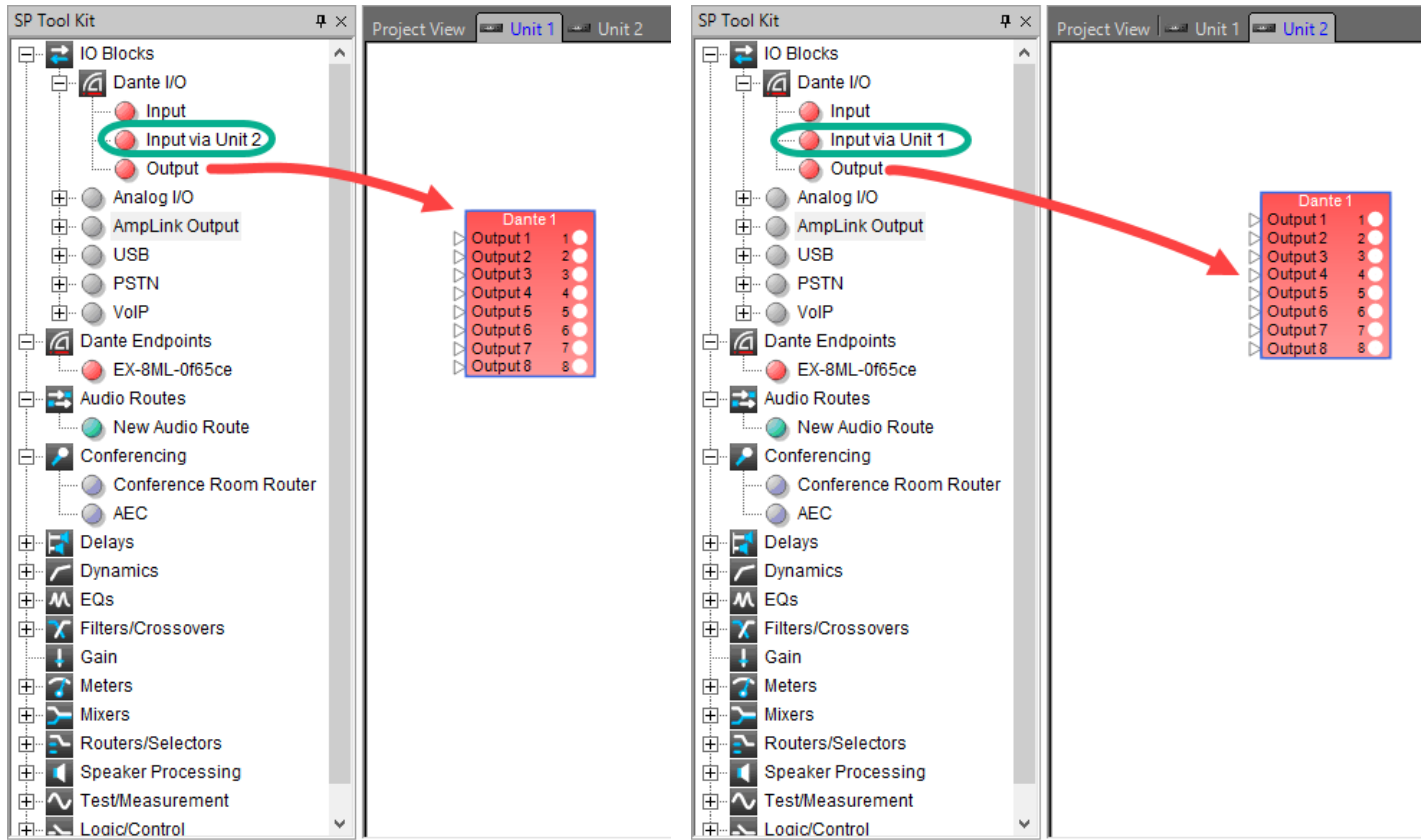

SP Tool Kit for Unit 1 processor listing Dante audio route Input via Unit 2 block

SP Tool Kit for Unit 2 processor listing Dante audio route Input via Unit 1 block

When a Dante audio route input block (Input via Unit n in this example) in the SP Tool Kit is dragged into the Signal Processing View of one EX-1280C processor, the Dante I/O blocks in both processors' Signal Processing Views now display the Dante logo and a DAR (Dante Audio Route) designation. Once the Dante logo appears on the block, the Dante I/Os are now paired and a Dante audio route is created.

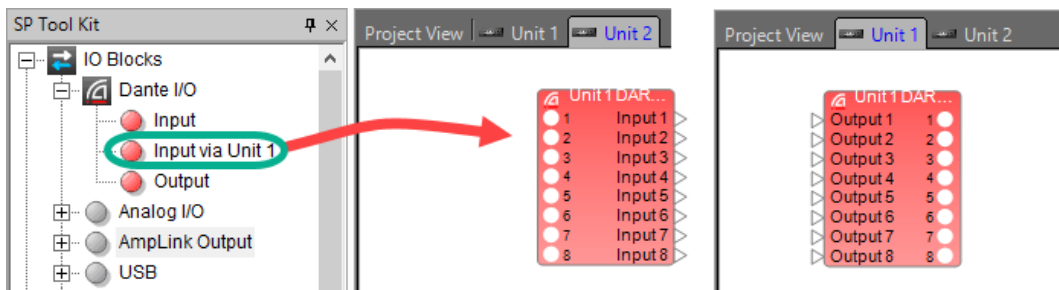

Paired Dante audio route

Conference Room Combining and Dante Audio Routes

In conference room combining applications, when multiple CRR blocks are spread across different EX-1280C processors, CSD automatically adds all of the required Dante audio routes between each CRR that is included in the same RCGroup (see [RCGroups](#)).

In the following example, there are three EX-1280C processors named Units 1, 2, and 3. Each has one CRR block added to its Signal Processing View. Only the CRR for Unit 1 has been added to RCGroup 1, so far.

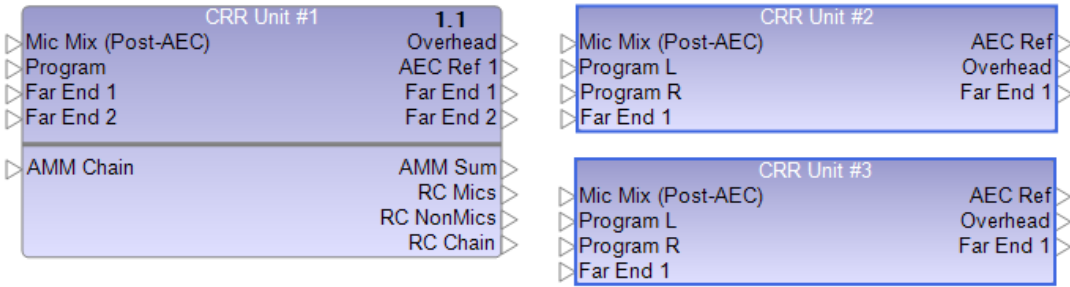

When the CRRs for Units 2 and 3 are added to the same RCGroup as the CRR in Unit 1 (in this case, RCGroup 1), CSD automatically creates all of the Dante audio routes needed.

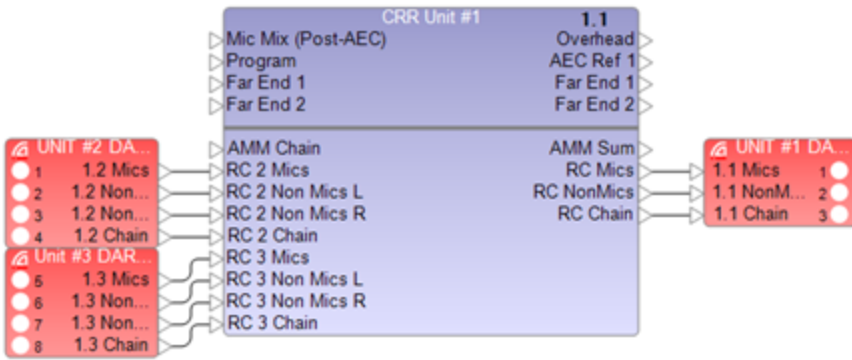

CRR for Unit 1 - Dante audio routes

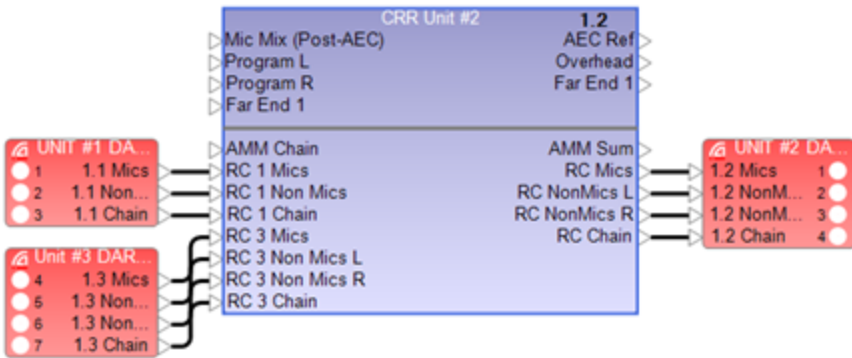

CRR for Unit 2 - Dante audio routes

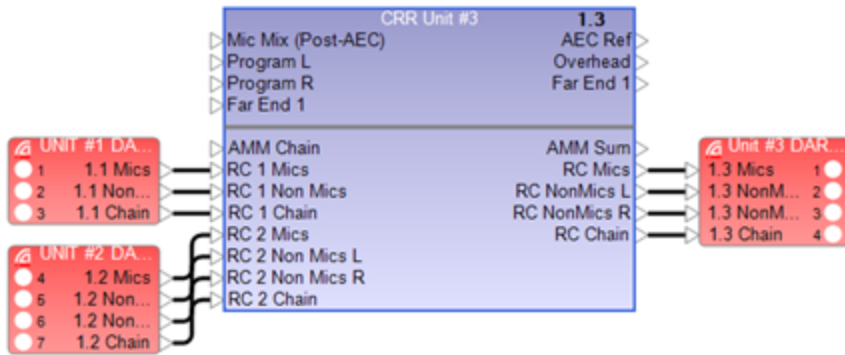

CRR for Unit 2 - Dante audio routes

Supported Signal Processing Algorithms for EX-1280C

Acoustic Echo Cancellation - AEC

The Acoustic Echo Cancellation (AEC) processing block is designed to eliminate the reintroduction of acoustically reflected sound waves and echo heard by far-end participants within a conferencing environment.

Setting the Number of Ports

Each AEC consists of a pair of blocks:

- AEC block
- AEC REF (reference) block

The AEC block is used to connect microphone sources that reference the source connected to the paired AEC REF block. The AEC block supports up to 12 input and output ports and the AEC REF block supports one input port. Only the number of ports on the AEC block can be changed.

To set the number of input and output ports for the AEC block:

1. Drag the AEC block into Signal Processing View.
2. Select or type in the number of input/output ports (12 max) using the Number of channels selector control.

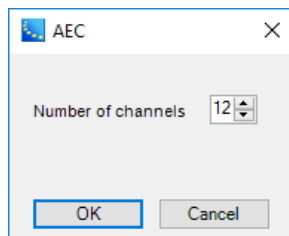

3. Click **OK**. The AEC and AEC REF blocks are now added to the Signal Processing View.

You can add inputs/outputs to an AEC block at any time by right clicking on the block and selecting **Change Channel Count**. You can then select the number of channels to add, up to a maximum of 12 per input or output.

Adding Multiple AEC References to an EX-1280C

The EX-1280C supports a maximum of 12 AEC inputs/outputs and four AEC REF inputs. Because AEC devices are paired (AEC and AEC REF blocks), adding an AEC block with 12 inputs would limit you to only one AEC REF block with one input.

To add more AEC references to an EX-1280C, add AEC blocks with fewer than 12 inputs/outputs but no more than 12 inputs/outputs for all blocks combined.

For example, to add the maximum number of AEC references to the system, add four, three-input AEC blocks to the design. Each three-input AEC block will have its paired AEC REF, for a total of four separate independent AEC references.

AEC Blocks and Control Panel

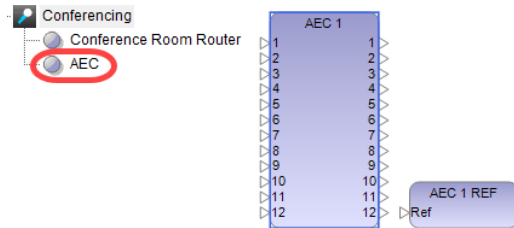

AEC processing blocks

AEC control panel

The **AEC control panel** provides the following options for each channel:

Input Meter– displays the incoming signal level of a connected microphone source.

ERL Meter– displays the difference in level between echo at the microphone input and the original far-end source at the AEC reference. Good gain structure and isolation between loudspeakers and microphones will result in a negative ERL value. Avoid high gain or close placement of microphones and loudspeakers, which will result in a positive ERL.

ERLE Meter– displays the amount of cancellation currently being achieved by the AEC's adaptive filter. A more-negative ERLE value means more echo is being removed.

NLP (Non-Linear Processing) - provides additional processing to help abate residual acoustic echo in less-than-ideal acoustic environments. The more difficult the acoustics are in a space, the higher the NLP setting may need to be set to ensure that acoustic echo is not passed to the far end. Should be used with care as there can be functional system trade-offs when too much NLP is applied. One of these trade-offs often manifests itself in the form of limiting full-duplex communications. Three levels are available: Light, Medium, or Strong.

NR (Noise Reduction) - can be applied to the input signal connected to an AEC block. This can be very helpful in eliminating persistent background noise that may be coming from HVAC systems or other sources. Use the up and down arrows to select a value or type it in. Range is 0dB (no filtering) to +32dB. Default: +12dB.

AEC Enable/Disable - click the AEC toggle to turn the AEC function on or off for the input channel. The AEC toggle turns green when AEC is active and is gray when it is inactive.

Mute - click the **Mute** toggle to mute or unmute the input channel. The **Mute** toggle turns red when the channel is muted and is gray when it is unmuted.

The **AEC control panel** provides the following additional options:

Reference Meter - displays the incoming level of the source connected to the AEC Reference block of the AEC signal processing block, i.e. Telco Rx, VoIP Rx, Far-End VTC, etc.

Comfort Noise - after the AEC filter, the NLP filter, and especially the NR filter have all done their work, the resulting audio signal is often nearly completely silent. This can cause problems because the far end may wonder if the call has been dropped when the audio goes silent. Comfort noise can be used to add a small amount of continuous noise back into the audio signal so the far end knows that the call is still ongoing.

Click the Comfort Noise ON/OFF toggle to enable or disable this feature for the AEC block. The ON/OFF toggle turns green when the Comfort Noise feature is active and is gray when it is inactive.

AGC

Automatic Gain Control (AGC) combines a compressor and a gate to maintain a constant output signal level with varying input signal levels. Both a monaural AGC with one input and a stereo AGC with two inputs are supported.

Control panels for mono and stereo versions are similar. The stereo AGC adds a Detector drop down list.

Double-click on the AGC block in Signal Processing View to open its control panel.

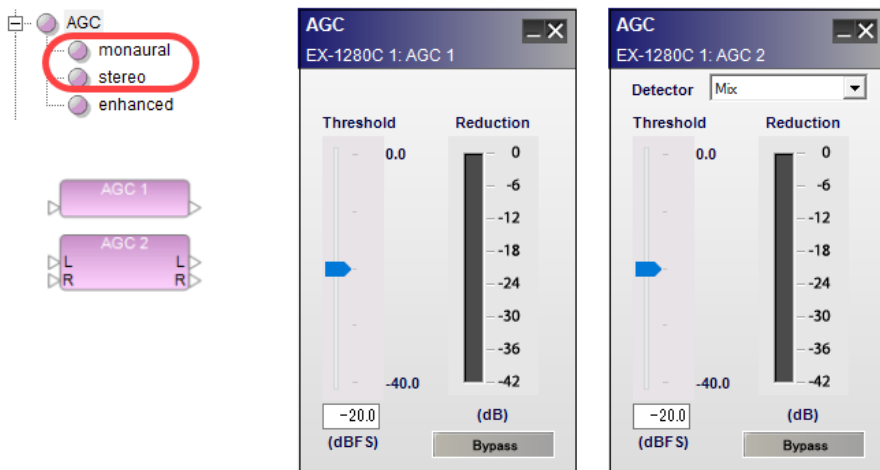

AGC processing blocks and control panels

The AGC control panel provides the following options:

Detector – (stereo only) determines which of the available signal inputs are monitored to trigger the signal processing.

Left - indicates the left signal is the trigger for processing.

Right - indicates the right signal is the trigger for processing.

Mix - indicates a left/right mix signal is the trigger for processing.

Threshold slider – determines when the processing block will begin adjusting the input signal according to its level. When the signal drops below this threshold, the input is prevented from passing through the processing block.

Threshold gain value – is entered directly into the box. The range of adjustment is -40 to 0 dBFS (default) and tracks the threshold slider setting.

Reduction graph – displays a vertical bar level indicator to illustrate the amount of signal reduction applied based upon the currently defined processing values.

Bypass – forces the channel to remain open at all times by circumventing the detection circuitry.

Enhanced AGC

The Enhanced Auto Gain Control (Enhanced AGC) SP block automatically adjusts the gain so that the signal level is within the specified range. Summary of the signal processing behavior of the Enhanced AGC block:

- When the input signal level exceeds the Max Target value, Enhanced AGC reduces the gain so that the output signal level equals the Max Target value.
- When the input signal level is less than the Min Target value, Enhanced AGC increases the gain (boost) so that the output signal level equals the Min Target value.
- When the input signal level is between the Min Target and the Max Target values, Enhanced AGC sets the gain to 0 dB.
- When the input signal level is less than the Activity Threshold value, Enhanced AGC sets the gain to 0 dB and does not boost the signal. Enhanced AGC does not become active until the input signal exceeds this threshold.

NOTE: Enhanced AGC functionality is supported only by the EX-1280C sound processor.

Setting the Number of Channels

The Enhanced AGC block supports from 1-32 input and output ports. To set the number of input and output channels for an Enhanced AGC block:

1. Drag the Enhanced AGC block into Signal Processing View.
2. In the AGC Enhanced dialog, select or type in the number of input/output channels (32 max) using the Channels selector control.

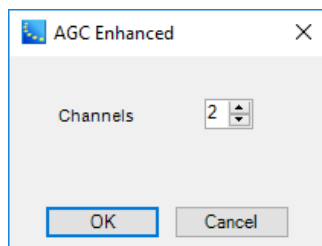

3. Click **OK** to add the block to the Signal Processing View.

You can add inputs/outputs to an existing Enhanced AGC block at any time by right clicking on the block and selecting **Change Channel Count**. You can then select the number of channels to add, up to a maximum of 32 inputs and 32 outputs.

Enhanced AGC Block and Control Panels

Double-click on the Enhanced AGC block in Signal Processing View to open its control panel.

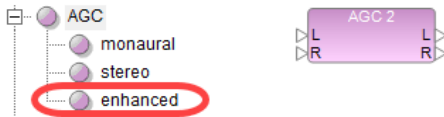

Enhanced AGC processing block

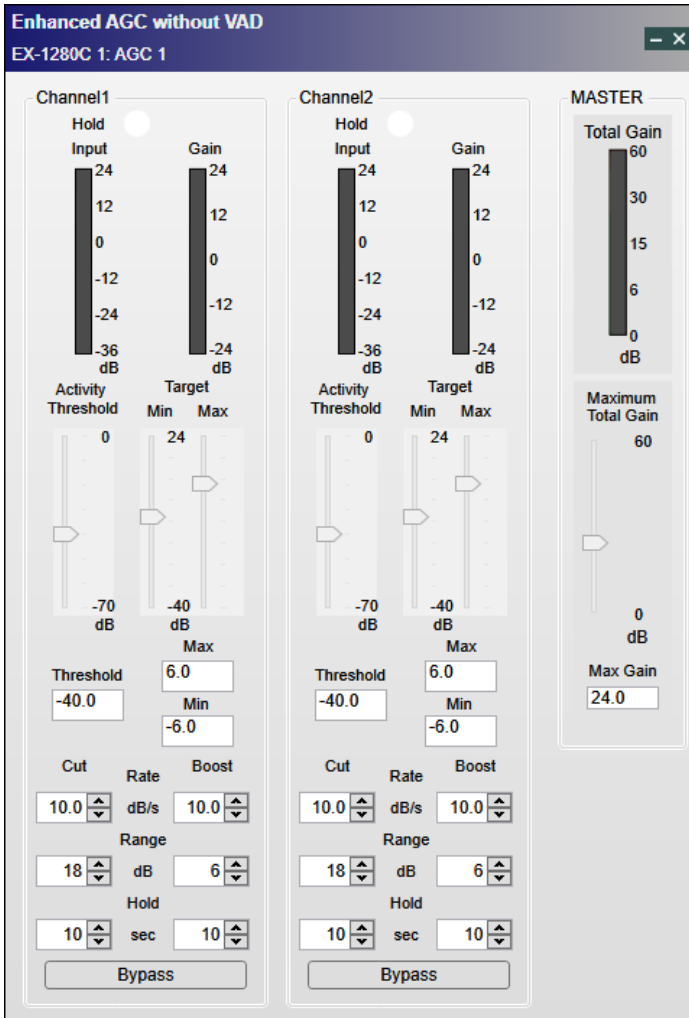

Enhanced AGC control panel

The Enhanced AGC control panel provides the following controls for each channel:

Hold - indicates a hold state. When the input signal level transitions from a state above the Activity Threshold to a state below the Activity Threshold, the channel is in the hold state. When the channel is in the hold state, this indicator turns blue. Otherwise, this indicator turns white.

Input - indicates the signal level coming into the channel, in dB.

Gain - indicates the gain that is applied to the channel by the algorithm, in dB.

Activity Threshold slider - sets the threshold for the minimum value of the input signal level at which the Enhanced AGC algorithm becomes active. When the input signal level is less than Activity Threshold, Enhanced AGC sets the gain to 0 dB and does not boost the signal. When the input signal level exceeds the Activity Threshold, the gain is adjusted per the other settings described in this section. The range of adjustment is from -70 to 0 dB, and the default value is -40 dB.

Threshold value - entered directly into the box. It tracks the Activity Threshold slider setting.

Min Target slider - sets the Min Target value. When the input signal level is less than the Min Target but greater than the Activity Threshold, Enhanced AGC increases the gain (boost) so that the output signal level becomes equivalent to the Min Target. The range of adjustment is from -40 to 24 dB, and the default value is -6 dB. **Note:** You cannot set this value greater than the value of the Max Target.

Min value - entered directly into the box. It tracks the Min Target slider setting.

Max Target slider - sets the Max Target value. When the input signal level is greater than the Max Target, Enhanced AGC reduces the gain so that the output signal level equals the Max Target value. The range of adjustment is from -40 to 24 dB, and the default value is 6 dB. **NOTE: You cannot set this value lower than the Min Target value.**

Max value - entered directly into the box. It tracks the Max Target slider setting. **NOTE: When the input signal level is between the Min Target and the Max Target, Enhanced AGC sets the gain to 0 dB.**

Cut Rate - sets the change speed of the gain when the input signal level is greater than Max Target. The range of adjustment is from 0 to 9000 dB/s, and the default value is 10 dB/s.

Boost Rate - sets the rate of change of the gain when the input signal level is less than the Min Target and greater than the Activity Threshold. The range of adjustment is from 0 to 9000 dB/s, and the default value is 10 dB/s.

Cut Range - sets the maximum amount of attenuation when the input signal level is greater than the Max Target. The range of adjustment is from 0 to 30 dB, and the default value is 18 dB. **NOTE: Since the attenuation will not exceed the value of Cut Range, the signal level may not decrease to the Max Target value when the input signal level is very high.**

Boost Range - sets the maximum amount of the boost when the input signal level is less than the Min Target and greater than the Activity Threshold. The range of adjustment is from 0 to 30 dB, and the default value is 6 dB. **NOTE: Since the boost will not exceed this value, the signal level may not be boosted up to the Min Target when the input signal level is very low.**

Cut Hold - sets the hold time when the input signal level changes from the state in which it is greater than the Max Target to the state in which it is lower than the Activity Threshold. The gain is held during hold operation. The range of adjustment is from 0 to 60 sec, and the default value is 10 sec.

Boost Hold - sets the hold time when the input signal level changes from the state in which it is greater than Activity Threshold to the state in which it is lower than Activity Threshold. The gain is held during hold operation. The range of adjustment is from 0 to 60 sec, and the default value is 10 sec.

Bypass - removes the channel from the algorithm and allows its signal to pass through the Enhanced AGC with no attenuation or boost. Bypass button turns red when the bypass is turned on, and turns gray when the bypass is turned off.

The **Enhanced AGC** control panel provides the following additional options:

Total Gain - indicates the total boost gain of all channels. If a channel is attenuated, its gain is not included in this total - only boost gain is included.

Maximum Total Gain slider - sets the maximum value for the total boost amount of all channels. You can limit the total boost amount of all channels with this setting. The range of adjustment is from 0 to 60 dB, and the default value is 24 dB.

The Maximum Total Gain option prevents the combined gain boost of all currently boosting channels from exceeding this limit. This limitation on boost amount is achieved by gain allocation. The gain of each channel is allocated in proportion to the gain of the channel which it would receive if it were the only active channel. For example, channel A alone would get +16 dB and channel B alone would get +14 dB. If Maximum Total Gain is set to +15 dB, then channel A gets +8 dB and channel B gets +7 dB.

Max Gain value - entered directly into the box. It tracks the Maximum Total Gain slider setting.

Array EQ

The Array EQ signal processing function provides specialized equalization for RoomMatch[®] array module loudspeakers. This unique EQ processor may be used as a general purpose room compensation EQ for standard systems.

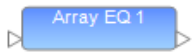

To access the Array EQ control panel, double click on its signal processing block in the Signal Processing View. The default state of the Array EQ is Bypass, to provide a flat initial response.

The following controls are available within the Array EQ:

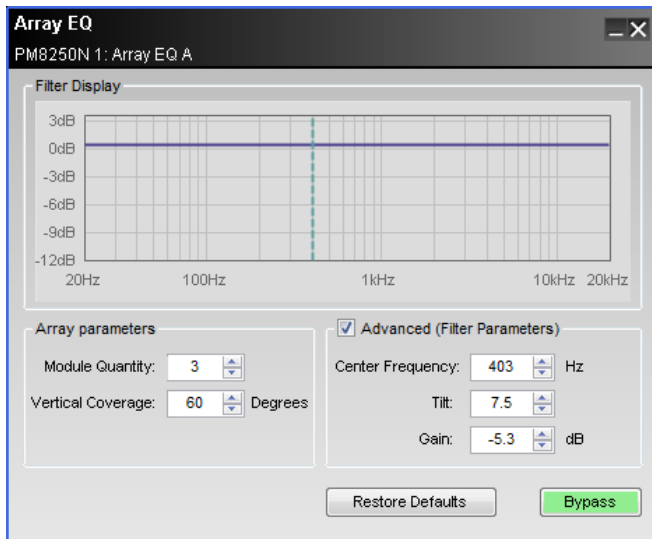

Filter Display - displays a graphical representation of array equalization settings in both frequency and level. The line represents the composite frequency response of chosen array and advanced filter parameters.

Array Parameters - specifically for use with Progressive Directivity Arrays.

Module Quantity - selects the quantity of loudspeaker modules within the array.

Vertical Coverage - enters the total vertical coverage angle, in degrees, of the array.

Advanced (Filter Parameters) - the Array EQ is represented by three basic filter controls: Center Frequency, Tilt, and Gain. Using these controls, the basic array filter may be modified.

Center Frequency - center frequency of the filter, represented by the dashed line in the Response Graph.

Tilt - adjusts the start and end points of the filter's slope on either side of the center frequency. Tilt is adjustable between 0 and 10 in steps of 0.3, the greater the tilt the steeper the filter slope.

Gain - amount of boost or cut applied to the filter below the center frequency. Gain is adjustable in 0.3 dB steps between -12 and +2 dB.

Bypass - bypasses the array equalization (flat response).

Automatic Microphone Mixers

Automatic Microphone Mixer - Gain Sharing

The Automatic Microphone Mixer (AMM) - Gain Sharing SP block for the ESP-880/1240/1600/4120 and EX-1280C sound processors assigns gain values across multiple input channels such that the total gain of the system remains the same. Each input channel is attenuated by an amount equal to the difference

between that channel's level and the sum of all channel levels, in dB. When using this algorithm, the strongest signals are attenuated the least and the weakest signals are attenuated the most.

NOTE: The ESP-00 II does not support AMM - Gain Sharing functionality.

Setting the Number of Channels

The AMM - Gain Sharing block supports from 4-32 input channels. To set the number of mic input channels for an AMM - Gain Sharing block:

1. Drag the AMM - Gain Sharing block into Signal Processing View.
2. In the AMM dialog, select or type in the number of mic input channels, using the Number of mics selector control.

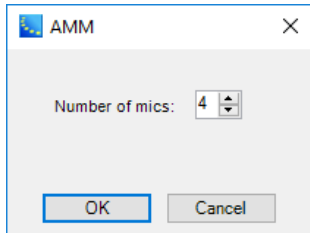

3. Click **OK** to add the block to the Signal Processing View.

You can add inputs to an existing block at any time by right clicking on the block and selecting **Change Channel Count**. You can then select the number of channels to add, up to a maximum of 32.

Logic Support (EX-1280C Only)

For the EX-1280C sound processor only, you can control the mute function of the mix output and control the mute state of each channel via logic inputs. The current state of each mute is communicated via logic output ports. For more information on logic support for AMM - Gain Sharing blocks, see [Logic and Testing Support for SP Blocks](#).

Linking AMM - Gain Sharing Blocks (EX-1280C Only)

You can expand the number of channels by linking multiple AMM - Gain Sharing blocks together (see [Linking AMM Blocks to Extend Channels](#)). You can also link these blocks on different sound processors or establish a link by connecting an AMM - Gain Sharing block with the Conference Room Router block. When you link multiple blocks, you need to set the link mode of each block to Master or Slave. If you are not using multiple linked blocks, you should set the link mode of the AMM - Gain Sharing block to Standard.

NOTE: The ESP sound processors do not support the linking of any AMM blocks, Gated or Gain Sharing.

AMM - Gain Sharing Block Configurations

There are several AMM - Gain Sharing block output configurations available. Default standard unlinked block provides a single output channel that outputs only the **Mix**.



AMM Gain-Sharing Block - Standard with four inputs and a mix output

Direct Output Block - You can configure the block to output not only the **Mix** but also a **Direct Output** for each input channel. To add direct output channels to the block, right click on the block and select **Enable Direct Outputs**.



AMM Gain-Sharing Block - Standard with mix and direct outputs

Master Link Mode Block - If the Link mode is set to Master for the block, Mix and Chain ports are added to the input side, and Sum is added to the output side. The Master block is designated with an **M** in the lower-right corner of the block:

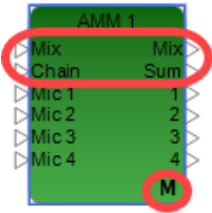

AMM Gain-Sharing Block - Master with mix and direct outputs

Slave Link Mode Block - If the Link mode is set to Slave for the block, Mix, Sum, and Chain ports are added to the input side, and Chain is added to the output side. The Slave block is designated with an **S** in the lower-right corner of the block:

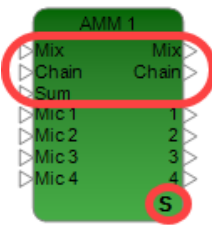

AMM Gain-Sharing Block - Slave with mix and direct outputs

AMM Gain Sharing Block Control Panel

Double-click on the AMM - Gain Sharing block in Signal Processing View to open its control panel.

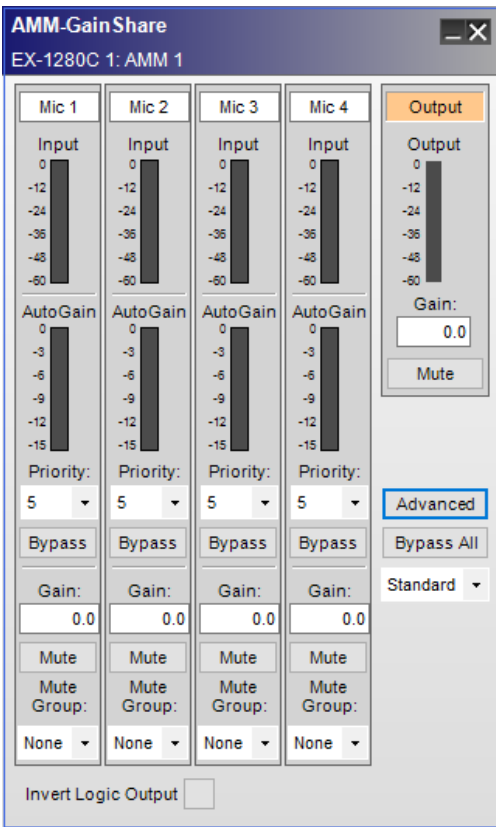

AMM - Gain Sharing Control Panel - Offline

Here is the view of the same control panel on-line with input and output signals.

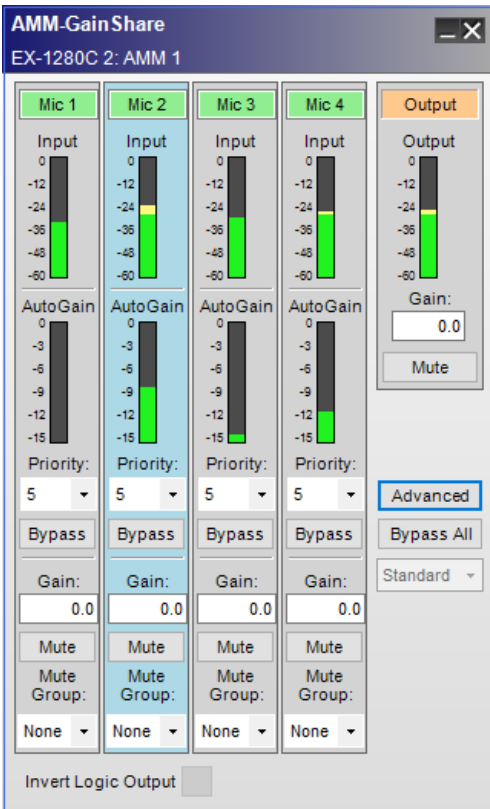

AMM - Gain Sharing Control Panel - On-line

When on-line, the background color of the channel with the highest gain turns light blue. If a signal is present in a channel, the background color of the Mic label turns green.

The **Automatic Microphone Mixer - Gain Sharing** control panel provides the following controls for each input:

Mic - specifies each microphone input channel. The input channel label can be renamed by the user. When in on-line mode, the background color of the label turns green if a signal is present.

Input - indicates the signal level coming into the microphone, in dBFS.

AutoGain - indicates the gain that is applied to the channel by the algorithm, in dB.

Priority - assigns a priority level to each channel. Setting a channel's priority level causes the algorithm to treat the channel as if its level were higher than it actually is. This results in microphones with higher priority receiving more gain relative to the others. Priority level 1 is the highest priority level. Priority level 5 applies no priority adjustment, and is the default priority level for all microphones.

Bypass - removes the channel from the algorithm and allows its signal to pass through the mixer with no attenuation. A bypassed channel does not affect the algorithm's auto-gain calculations.

Gain - adjusts the post-gate output level of the input channel. The range of adjustment is $-\infty$ to 12 dB. Default value is 0 dB.

Mute - silences the input channel. Mute is applied pre-auto-gain; therefore, a muted channel's signal level *does not* affect the algorithm's auto-gain calculations.

Mute Group - determines the mute group number of the channel. The muting operation of multiple channels which have the same mute group number is synchronized; that is, if one mic in mute group 1 is muted, all mics in mute group 1 will be muted. Select None (default) or assign a mute group number from 1 to the total number input channels minus 1. "None" means the mute function of this channel is not synchronized with other channels.

Output - this section of the control panel includes an Output Level indicator, Gain setting, and Mute button. It also includes advanced options, Bypass All setting and Link mode selection.

Output - indicates the output level from the block, in dBFS.

Gain - adjusts the overall output level of the AMM - Gain Sharing block.

Mute - silences all output from the mixer.

Advanced - expands the properties available, with an additional options for **Output slope** and **Time Constants**.

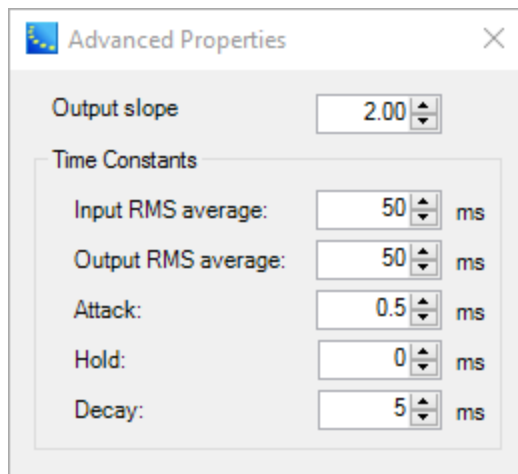

AMM - Gain Sharing advanced properties dialog

Output slope - default value for output slope is 2.00. An output slope of 2.00 means that each channel will receive exactly the amount of gain that the algorithm assigned to it. The value of

the output slope can be set to any value between 0.01 and 2.00. When the output slope is at its minimum value, 0.01, the auto-mix-gain equals almost 1 (before being converted to dB). Any slope between the minimum and maximum will be an auto-mix-gain value between its originally assigned value and 1.

Time Constants

Input RMS average - length, in milliseconds (ms), of the RMS averaging for the detection of signal levels. Default value is 50.0 ms.

Output RMS average - length, in milliseconds (ms), of the RMS averaging for the detection of the output level. Default value is 50.0 ms.

Attack - amount of time, in milliseconds (ms), from when the microphone signal is detected until it is fully open. Default value is 0.5 ms, and the range is 0.5 to 100.0 ms.

Hold - amount of time, in milliseconds (ms), that the microphone will remain open once the signal is no longer present. Default value is 0 ms.

Decay - amount of time, in milliseconds (ms), required for the microphone to transition from its open state to its fully attenuated state. Default value is 5.0 ms.

Bypass All - allows all signals to pass through the mixer with no attenuation.

Link mode - sets one of the following link modes for the block:

Standard - unlinked mode (default). Use this if you are not linking any blocks.

Master - when you link blocks without CRR, you must set the link mode of one block to **Master**.

Slave - when you link blocks, you must set any block to **Slave** link mode that is not set to Master link mode.

Invert Logic Output - when this option is selected, the logic output of the block is **High** when the block's audio output is unmuted and **Low** when the block's audio output is muted. If this option is not selected, the logic output of the block is **Low** when the block's audio output is unmuted and **High** when the block's audio output is muted. For more information on logic support for AMM - Gain Sharing blocks, see [Logic and Testing Support for SP Blocks](#).

AMM - Gain Sharing Functional Block Diagram

The AMM - Gain Sharing functional diagram illustrates the signal flow and logic operations of the block.

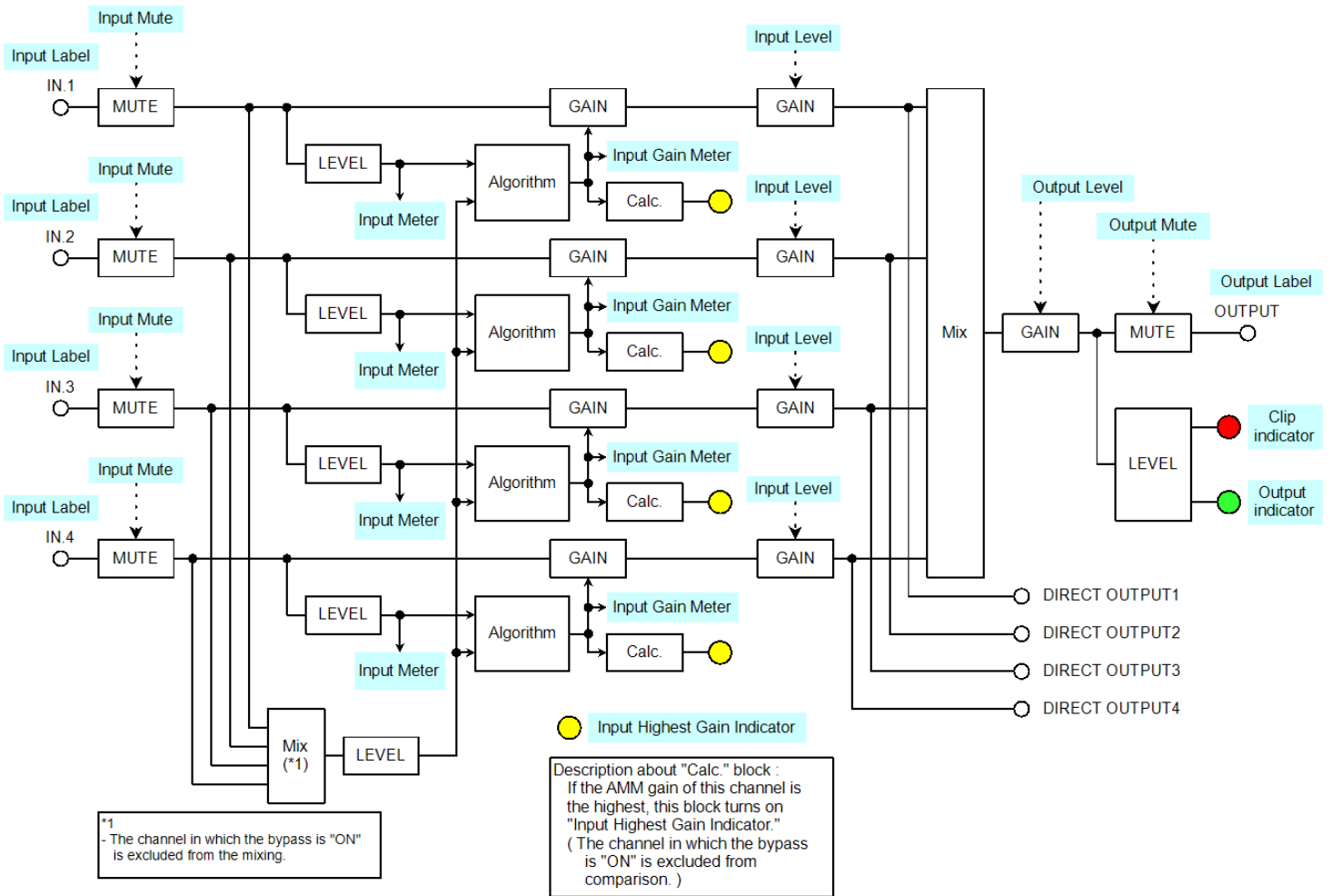

AMM - Gain Sharing functional block diagram

Automatic Microphone Mixer - Gated (EX-1280C only)

The **Automatic Microphone Mixer - Gated** processing block for the ESP-880/1240/1600/4120 and EX-1280C sound processor manages the signal level from multiple microphones to achieve a constant output level without user intervention.

You can control the mute function of the mix output and control the mute state of each channel via logic inputs. The current state of each mute is communicated via logic output ports. For more information on logic support for AMM - Gated blocks, see [Logic and Testing Support for SP Blocks](#).

Adaptive Threshold Sensing (ATS) options are available. ATS detects the ambient noise from the input signal by a BSF (Band-stop Filter) and automatically determines the optimum gate threshold level, based on the ambient noise level detected.

NOTE: The ESP sound processors do not support the AMM-Gated functionality described in this topic, but rather an AMM-Gated processing block with predefined inputs and no logic or linking functionality. See [Automatic Microphone Mixer - Gated \(ESPs only\)](#) for more information.

Setting the Number of Channels

The AMM - Gated block supports from 2-32 input channels. To set the number of mic input channels for an AMM - Gated block:

1. Drag the AMM - Gated block into Signal Processing View.
2. In the dialog, select or type in the number of mic input channels, using the Number of mics selector control.

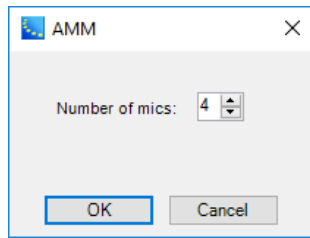

3. Click **OK** to add the block to the Signal Processing View.

You can add mic inputs to an existing block at any time by right clicking on the block and selecting **Change Channel Count**. You can then select the number of mic inputs to add, up to a maximum of 32.

Linking AMM - Gated Blocks

You can expand the number of channels by linking multiple AMM - Gated blocks together (see [Linking AMM Blocks to Extend Channels](#)). You can also link these blocks on different sound processors or establish a link by connecting an AMM - Gated block with the Conference Room Router block. When you link multiple blocks, you need to set the link mode of each block to Master, Slave, or CRC. If you are not using multiple linked blocks, you should set the link mode of the AMM - Gated block to Standard.

NOTE: The ESP sound processors do not support the linking of any AMM blocks, Gated or Gain Sharing.

AMM - Gated Block Configurations

There are several AMM - Gated block output configurations available. Default standard unlinked block provides a single output channel that outputs only the **Mix**.

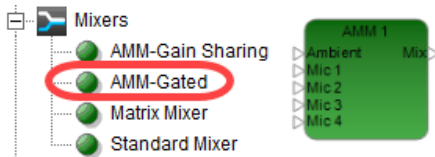

AMM Gated Block - Standard with four inputs and a mix output

Direct Output Block - You can configure the block to output not only the **Mix** but also a **Direct Output** for each input channel. To add direct output channels to the block, right click on the block and select **Enable Direct Outputs**.

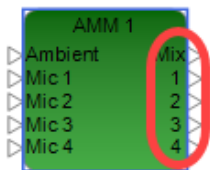

AMM Gated Block - Standard with mix and direct outputs

Master Link Mode Block - If the Link mode is set to Master for the block, Mix and Chain ports are added to the input side, and Sum is added to the output side. The Master block is designated with an **M** in the lower-right corner of the block. The Link ID is displayed in the upper-right corner:

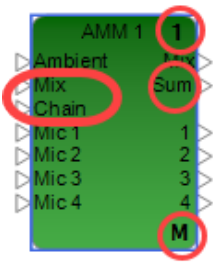

AMM Gated Block - Master with mix and direct outputs

Slave Link Mode Block - If the Link mode is set to Slave for the block, Mix, Sum, and Chain ports are added to the input side, and Chain is added to the output side. The Slave block is designated with an **S** in the lower-right corner of the block. The Link ID is displayed in the upper-right corner:

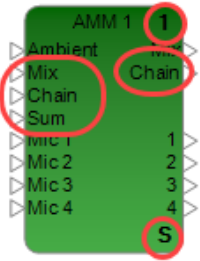

AMM Gated Block - Slave with mix and direct outputs

CRC Link Mode Block - If the Link mode is set to CRC for the block, Mix, Sum, and Chain ports are added to the input side, and Chain is added to the output side. The CRC block is designated with an **C** in the lower-right corner of the block:



AMM Gated Block - CRC with mix and direct outputs

AMM Gated Block Control Panel

Double-click on the AMM - Gated block in Signal Processing View to open its control panel.

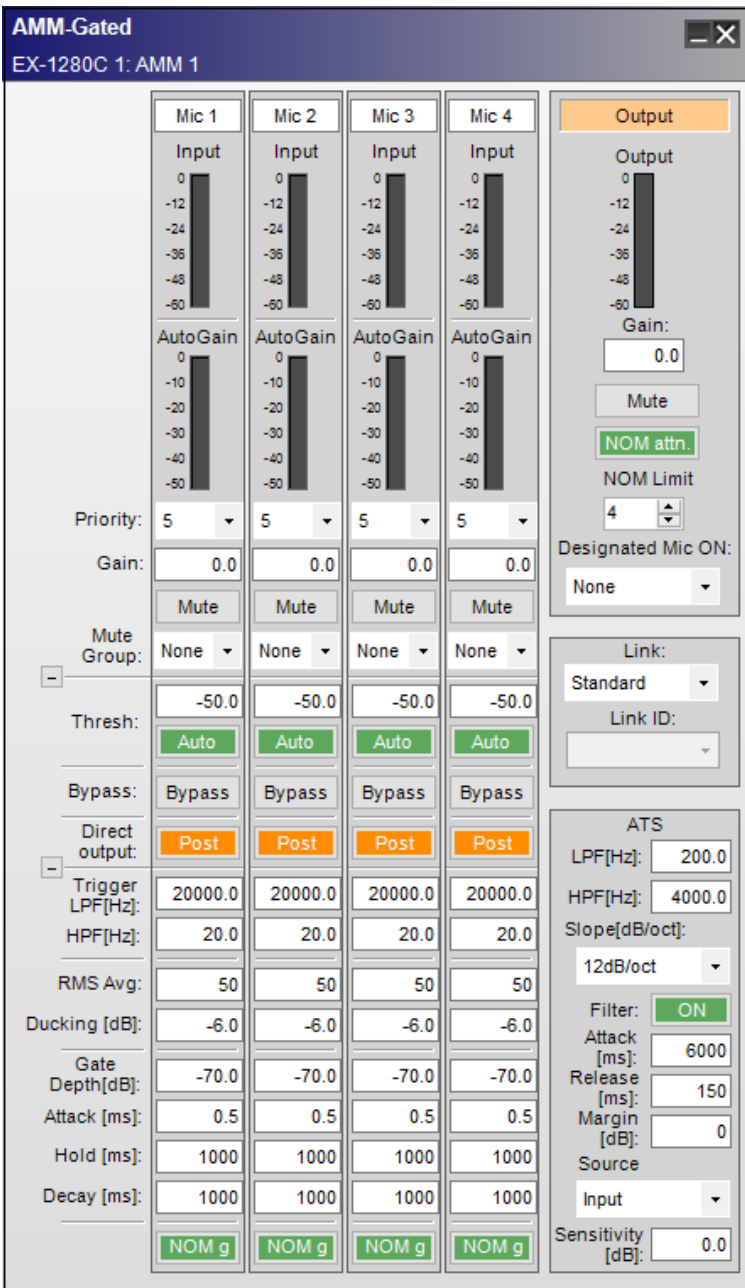

AMM - Gated Control Panel - Offline

Here is the view of an AMM - Gated control panel on-line with input and output signals.

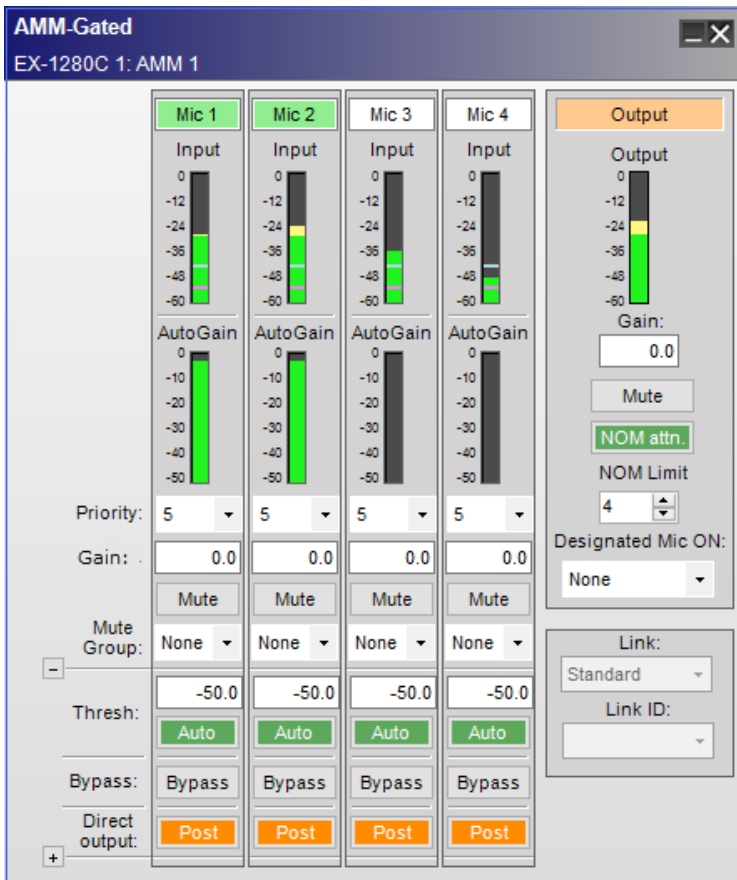

AMM - Gated Control Panel - On-line

When on-line, if the gate is open, the background color of the Mic label turns green. The ambient noise level is indicated as a purple line. Gate threshold level is indicated as a light blue line in the input level meter.

The **Automatic Microphone Mixer - Gated** control panel provides the following controls for each input:

Mic - specifies each input channel. The input channel label can be renamed by the user. When on-line, the background color of the label turns green if the gate is open.

Input - indicates the signal level coming into the microphone, in dBFS. The light blue line indicates the gate threshold level (detected by ATS or set manually). Purple line indicates the ambient noise level detected by Adaptive Threshold Sensing (ATS).

AutoGain - indicates the gain being applied to the channel by the algorithm, in dB. AutoGain consists of the total gain of Gate Gain, Ducking, and NOM attenuation.

Priority - assigns a priority level to each channel. Setting a channel's priority level forces the other lower-priority input channels to duck or reduce in level when this channel gates on. Priority level 1 is the highest priority level. Priority level 5 is equivalent to no priority adjustment, and is the default priority level for all microphones.

Level - adjusts the post-gate output level of the input channel. The range of adjustment is $-\infty$ to 12 dB. Default value is 0 dB.

Mute - attenuates the output of each channel. When Mute is enabled, the control panel button is red.

Mute Group - determines the mute group number of the channel. The muting operation of multiple channels which have the same mute group number is linked; that is, if one mic in mute group 1 is muted, all mics in mute group 1 will be muted. Select None (default) or assign a mute group number from 1 to the total number input channels minus 1. "None" means the mute function of this channel is not linked with other channels.

Options Expansion Panel - Upper - detailed options used for the input channel are displayed. Click the + or - button to show or hide the Upper Options Expansion Panel:

Thresh - enables a channel gate to open when a predetermined signal level is reached. When the signal drops below this threshold, the channel gate closes again. By default, gate threshold is set automatically by ATS.

You can switch the automatic / manual setting of the gate threshold level with the **Auto Threshold** button. When this button is green, the gate threshold level is automatically set by ATS. When this button is gray, the gate threshold level can be set manually and the value specified in the box is the gate threshold. Default is -50.0 dBFS and the range is -80.0 dBFS to 0.0 dBFS.

The gate threshold level is indicated as a light blue line in the input level meter.

Bypass - forces the channel to remain open at all times by circumventing the detection circuitry.

Direct Output - if direct outputs are enabled on the AMM - Gated block, you can select the direct output source as Pre or Post. Default setting is Post:

Pre (Post Gate / Pre NOM) - gate gain and ducking are applied to the direct output signal, NOM attenuation is not applied.

Post (Post Gate / Post NOM) - gate gain, ducking and NOM attenuation are applied to the direct output signal.

Options Expansion Panel - Lower - detailed options used for the input channel are displayed. Click the + or - button to show or hide the Lower Options Expansion Panel:

Trigger LPF - LPF cut-off frequency, in Hz. Default is 20.0 kHz and the range is 20.0 Hz to 20.0 kHz.

Trigger HPF - HPF cut-off frequency, in Hz. Default is 20.0 Hz and the range is 20.0 Hz to 20.0 kHz.

RMS Avg - value is the length, in milliseconds, of the RMS averaging performed on the detection signal chain. Default is 50 ms and the range is 0 to 500 ms.

Ducking - determines the amount of ducking applied to the channel when the priority channel is open. Default is -6.0 dB, and the range is -60.0 to 0.0 dB

Gate Settings:

Depth - amount of attenuation applied when the input gate is not open. Default is -70.0 dB, and the range is -70.0 to 0.0 dB.

Attack - time, in milliseconds, from when the gate is turned on until it is fully open. Default is 0.5 ms, and the range is 0.5 to 500 ms.

Hold - time that the gate will remain open once the signal is no longer present. Default is 1000 ms and the range is 1 to 50000 ms.

Decay - time required for the gate to transition from its open to fully attenuated state. Default is 1000 ms and the range is 1 to 50000 ms.

NOM Gain - determines whether this channel is added to the NOM count (the Number of Open Microphones). When NOM gain is On and turns green, the gate status of this channel affects the NOM count and NOM attenuation is applied to this channel. When NOM gain is Off and turns gray, the gate status of this channel does not affect the NOM count and NOM attenuation is not applied to this channel.

Output - includes an Output Level indicator, Gain setting, Mute button and options related to Number of Open Microphones (NOM).

Output - indicates the output level from the block, in dBFS.

Gain - adjusts the overall output level of the AMM - Gated block. Default is 0 dB and the range of adjustment is $-\infty$ to 0 dB.

Mute - attenuates the output channel. When Mute is enabled, the control panel button is red.

NOM Attenuation - activates the Number of Open Microphones (NOM) attenuation function. This applies $-10 * \text{Log}(\text{NOM})$ output attenuation to the channel.

NOM Limit - determines the maximum number of microphones that may be active at any time. Default is the total number of channels in the selected AMM - Gated block and the range of values is from 1 to the total number of channels in the selected AMM - Gated block.

When the link mode of the block is set to Master or Slave, the maximum value of NOM Limit is the total number of channels of linked AMM - Gated blocks. Linked AMM - Gated blocks share the same value of NOM Limit.

When the link mode of the block is set to CRC, the maximum value of NOM Limit is the total number of channels of the AMM - Gated block in CRC mode connected to the CRR / CRC block belonging to a specific RCGroup. The linked AMM - Gated block to which the rooms of the connected CRR are combined shares the same value as the NOM Limit.

The NOM Limit applies to all linked AMM - Gated blocks. It is not applied separately to each AMM - Gated block.

If the NOM Limit value is less than the number of microphones that are active, the following logic is used to determine which microphones are selected:

Priority - channels meeting all other conditions take precedence over lower priority channels.

First-come, first-served - activates channels in the order that required conditions are met and held.

Lowest-numbered channel - activates sequentially, starting from the lowest numerically valued channel in ascending order until the NOM limit is reached.

Designated Mic On - you can select the way to open the gate when no signal is present. Default is None. Options are:

None - gate is closed.

Ch. N (where *N* is the channel number) - allows the specified channel to remain open even after it falls below threshold. The channel continues to remain open until another channel becomes active.

Last Mic Hold - allows the channel that was last opened to remain open, even after it falls below threshold. The channel continues to remain open until another channel becomes active.

When you set the link mode of the block to Master or Slave, you can specify the channels of other AMM - Gated blocks in the link to Designated Mic On. Linked AMM - Gated blocks share the same Designated Mic On option setting.

When you set the link mode of the block to CRC, the Designated Mic On option can specify a channel of an AMM - Gated block in CRC mode connected to the CRR / CRC module belonging to a specific RCGroup. The linked AMM - Gated blocks with which the rooms of the connected CRR are combined share the same Designated Mic On option setting.

Link mode - sets one of the following link modes for the block:

Standard - unlinked mode (default). Use this if you are not linking any blocks.

Master - when you link blocks without CRR, you must set the link mode of one block to **Master**.

Slave - when you link blocks, you must set any block to **Slave** link mode that is not set to Master link mode.

CRC - when you link blocks with CRR room combining, you must set the link mode of one block to CRC.

Link ID - a link group number. Blocks with the same link ID are linked. For blocks in Master mode and Slave mode, specify the link ID when linking the blocks. Default is 1 and the link ID can be set from 1 to 8. For blocks in CRC mode, the link ID is automatically assigned by connecting to the CRR block belonging to the same RCGroup. If the AMM - Gated blocks have different link IDs, the NOM Limit option and Designated Mic On option will not function together correctly. **NOTE: Blocks with different link IDs cannot be linked. To configure separate linked groups of AMM blocks, make sure the AMMs in each have a different link ID. See [Linking AMM Blocks to Extend Channels](#) for more information.**

ATS (Adaptive Threshold Sensing) – detects the ambient noise from the input signal by BSF (Band-stop Filter) and automatically determines the optimum gate threshold level, based on the ambient noise level detected. Also, a microphone dedicated to ambient noise can be connected to the Ambient input of the AMM - Gated block and used as a source for the ambient noise.

LPF – lower cutoff frequency of BSF, in Hz. Default is 200.0 Hz and the range is 20.0 Hz to 20.0 kHz.

HPF – higher cutoff frequency of BSF, in Hz. Default is 4000.0 Hz and the range is 20.0 Hz to 20.0 kHz.

Slope – you can select slope of BSF as 6dB/oct or 12dB/oct. Default is 12dB/oct.

Filter – apply BSF to ATS source or remove it from ATS source. Default is On.

Attack – time constant for ambient noise level detector. This determines the speed of the rise of the measured ambient noise level. Default is 10000 ms and the range is 100 ms to 10000 ms.

Release – time constant for ambient noise level detector. This determines the speed of the fall of the measured ambient noise level. Default is 50 ms and range is 10 ms to 1000 ms.

Margin – determines the difference between ambient noise level and threshold level of gate. Default is 3.0 dB and the range is -18.0 to 18.0 dB.

Source – input source for ATS. Options are:

Input - sum of all input channels is used as the input source for ATS. This is the default.

Ambient input - connect a microphone dedicated to picking up ambient noise to the Ambient input port on the block and use it as the input source for ATS.

Sensitivity – you can adjust the sensitivity for the ambient noise of the Ambient input port on the block. For example, if the microphone which is used for sensing ambient noise is close to the source of ambient noise, and the microphone which is used to pick up the voice of a talker is far from the source of ambient noise, this setting should be lowered.

If the Ambient input is not used, this setting does not affect the operation of ATS. Default is 0.0 dB and the range is -20.0 dB to +20.0 dB.

NOTES:

- To open only the microphone closest to the talker, the channel with the highest input signal level is opened. This channel is called **Best Mic**.
- If multiple talkers speak, the channels with an input signal level of -5 dB or more relative to the level of the Best Mic channel are also opened.
- A channel with an input signal level less than -5 dB for the Best Mic channel level will not open even if it exceeds the gate threshold.
- The Best Mic algorithm is determined by the input signal level, and is not affected by Priority.

AMM - Gated Functional Block Diagram

The AMM - Gated functional diagram illustrates the signal flow and logic operations of the block.

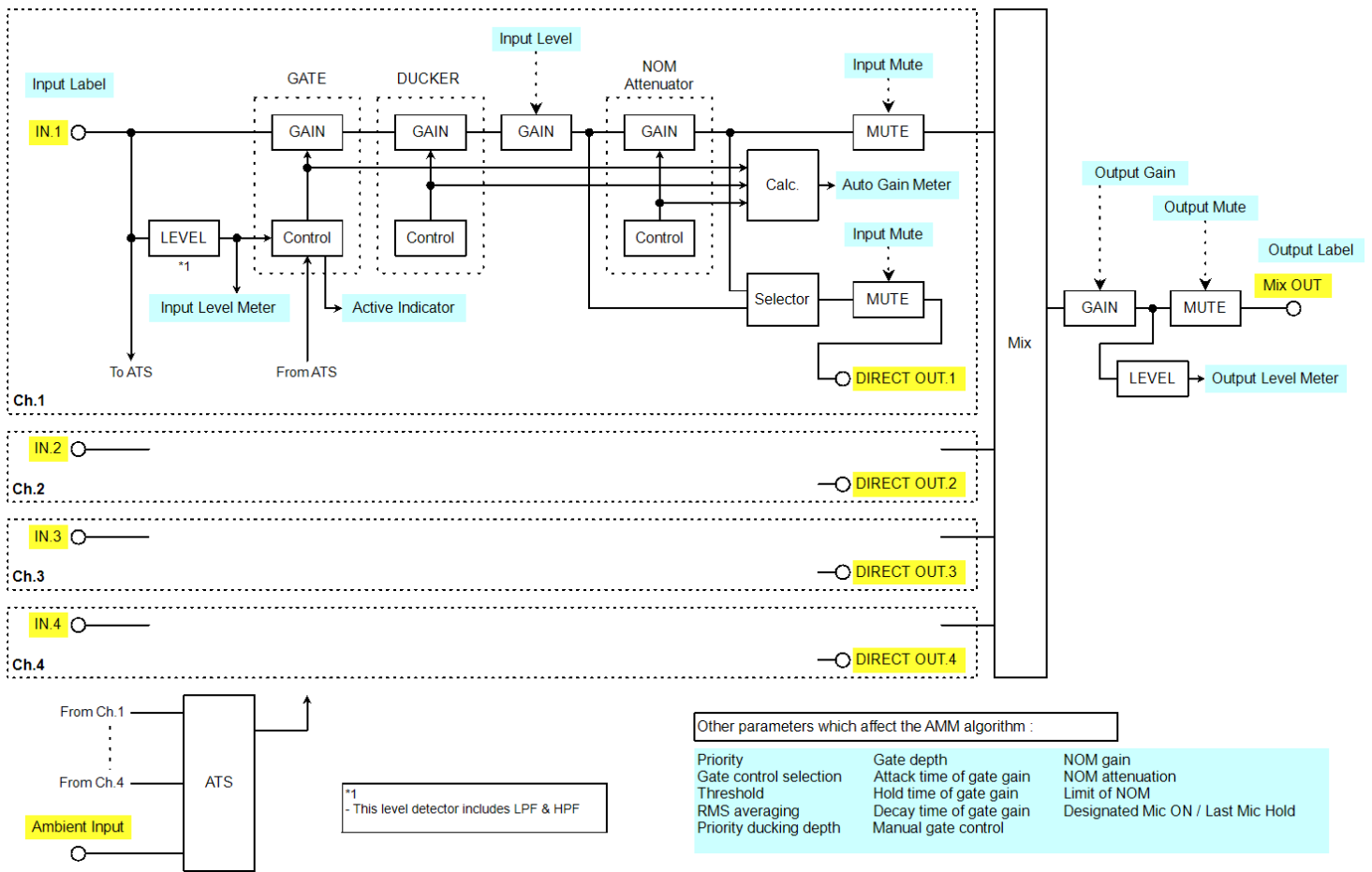

AMM - Gated functional block diagram

Linking AMM Blocks to Extend Channels

You can extend the number of channels in either an **Automatic Microphone Mixer - Gain Sharing** or **Automatic Microphone Mixer - Gated (EX-1280C only)** block in an EX-1280C by linking multiple AMM blocks together. For example, you can link two AMM blocks of 32 channels each to create a 64-channel block.

NOTE: The ESP sound processors do not support the linking of any AMM blocks, Gated or Gain Sharing.

When linking multiple AMM blocks, you must set the link mode of each block to either Master or Slave. There can be only one Master AMM block in the chain; the rest are set to Slave.

Also for AMM - Gain Sharing blocks, only blocks with the same link ID can be linked. Blocks with different link IDs are not linked. To configure separate linked groups of AMM - Gain Sharing blocks, make sure the AMMs in each group have a different link ID.

In the examples in the rest of this topic:

- The inputs and outputs of linked AMM blocks are connected via audio routes (see **Audio Routes**). If you need to link AMM blocks across two different sound processors, use Dante audio routes (see **Managing Dante Audio Routes**).
- Ambient inputs are not shown in the examples for AMM - Gated blocks. If you are using an ambient mic source, it must be connected to the Ambient inputs of all AMM - Gated blocks, both the Master and the Slaves.

See the sections in this topic (**Chain Inputs & Outputs**, **Sum Inputs & Outputs**, and **Mix Inputs & Outputs**) and the **Examples** to learn more. See **Linking CRR Blocks to Automatic Mic Mixer Blocks** to learn about linking AMMs to CRRs.

Chain Inputs & Outputs

The Chain input and output signal paths are as follows:

- Chain input - receives mix information, control and Chain signals from the Chain output of another linked AMM block.
- Chain output - outputs mix, control and Chain signal information to the Chain input of the next linked AMM block.

In effect, you cascade the Chain outputs and Chain inputs of the linked modules to create a loop in which the Master AMM block receives the Chain signal from the last Slave AMM block in the chain.

In the following example, AMM 1 is the Master and the remaining AMM blocks are Slaves. AMM 2 outputs the first Chain connection to AMM 3. AMM 3 receives the Chain signal from AMM 2 and outputs that combined Chain signal to AMM 1. AMM 1 receives the combined Chain signal from AMM 3, completing the chain.

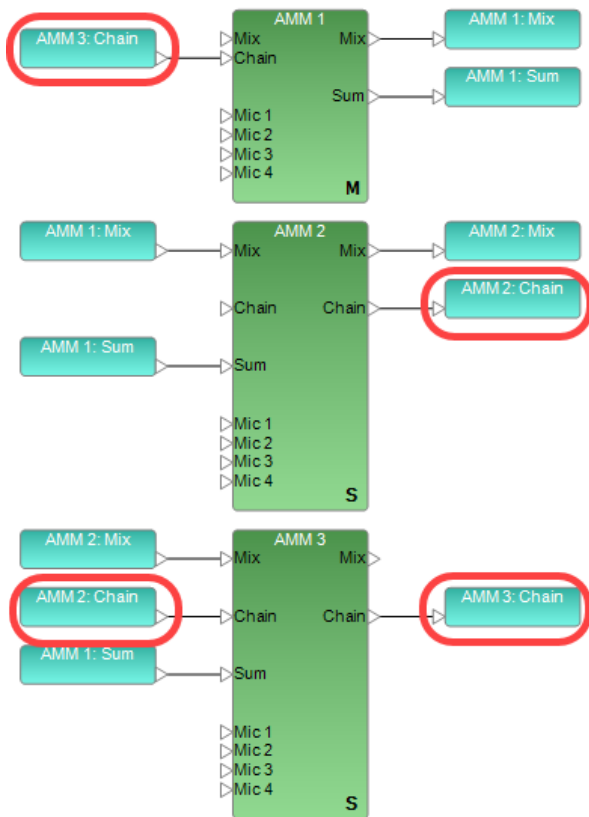

AMM Linking - Chain inputs and outputs

Sum Inputs & Outputs

The Sum input and output signal paths are as follows:

- Sum output - outputs a summed signal of mic inputs and Chain signals from the Master AMM block to all linked AMM blocks. The Sum output is only available on the Master AMM block.
- Sum input - receives the Sum output signal(s) from the Master AMM block. Sum inputs are only on the Slave AMM blocks, and all linked Slave blocks must have their Sum inputs receive the Sum output from the Master AMM block.

In the following example, the Sum output of Master block AMM 1 is connected to Sum inputs of Slave blocks AMM 2 and AMM 3.

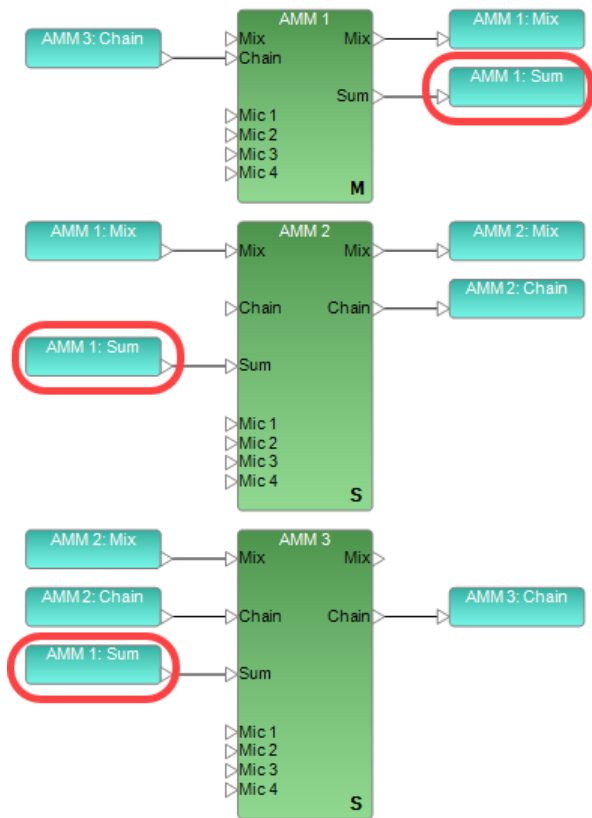

AMM Linking - Sum inputs and outputs

Mix Inputs & Outputs

The Mix input and output signal paths are as follows:

- Mix input - receives combined audio Mix from another AMM in the chain of linked AMM blocks.
- Mix output - outputs the combined audio Mix of the AMM block's internal inputs and any combined audio Mix from other AMMs in the chain connected through that AMM block's Mix input.

In the following example, the Mix output of AMM 1 is the top of the linked cascade connection. AMM 2 is the second in the cascade and AMM 3 is the last. Therefore, the Mix output of AMM 3 will contain the full mix of all connected AMM modules.

NOTE: The Master module does not have to be the first Mix output in the chain.

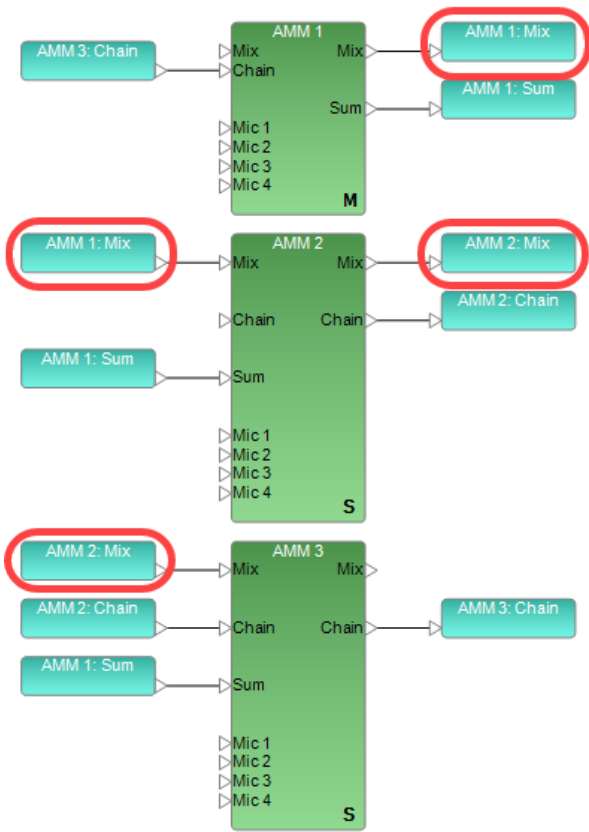

AMM Linking - Mix inputs and outputs

Examples

Cascading 3 AMMs

Below is an overview of how to design a 3-AMM system.

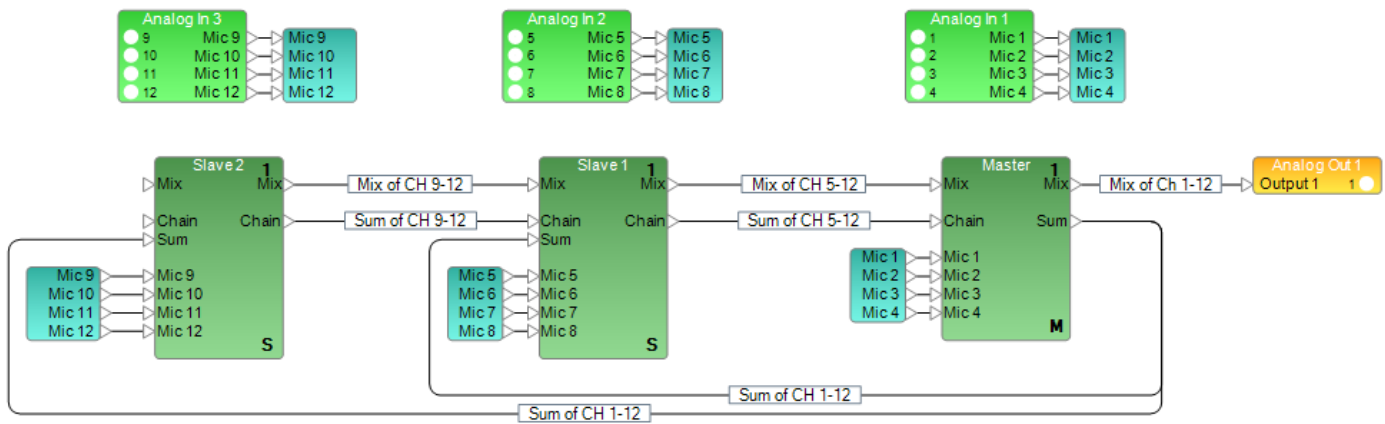

Slave 2 will send the sum of microphone inputs 9-12 (pre-gain) via the Chain output to Slave 1, and Slave 1 will send microphone inputs 5-8 (pre-gain) + the Chain input, via the Chain output to the master.

Master will send the sum (microphone channels 1-12) to the slave AMMs via the Sum output. This way each AMM can calculate the amount of gain needed for each microphone input channel.

The Mix outputs are cascaded, so on the Mix output of the Master you will have the gain controlled signal of microphone channels 1-12.

Linking 3 AMMs for 3 Separate Zones

Below is an overview of how to design a 3-zone, overhead system.

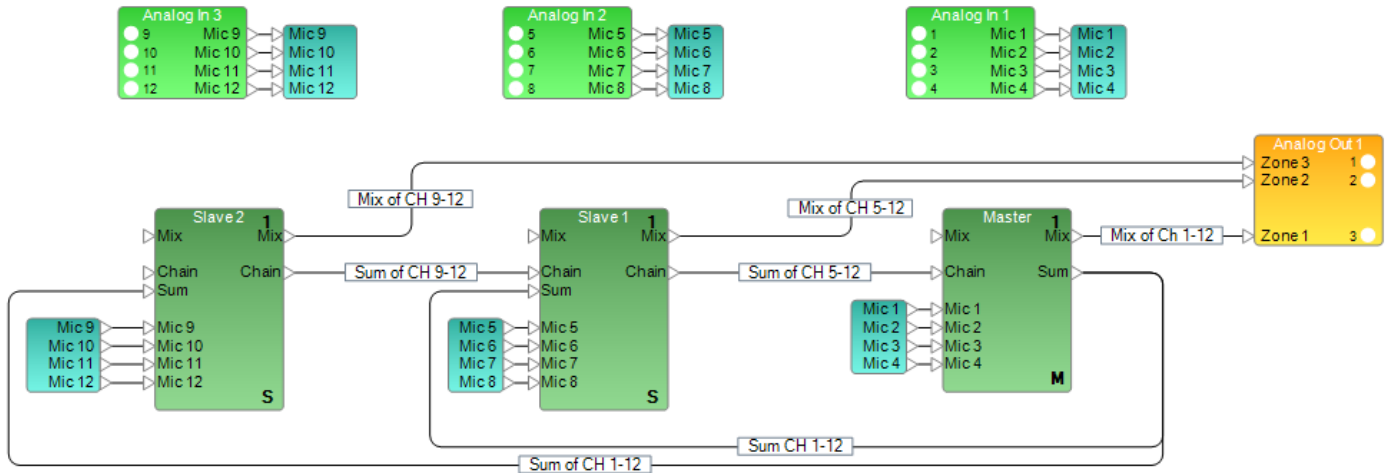

Slave 2 will send the sum of microphone inputs 9-12 (pre-gain) via the Chain output to Slave 1, and Slave 1 will send microphone inputs 5-8 (pre-gain) + the Chain input via the Chain output, to the master.

Master will send the sum (microphone channels 1-12) to the slave AMMs via the Sum output. This way each AMM can calculate the amount of gain needed for each microphone input channel.

In this case the Mix output is sent individually to 3 separate outputs.

Room Combining

Below is an overview of how to design a 3-zone room combining system.

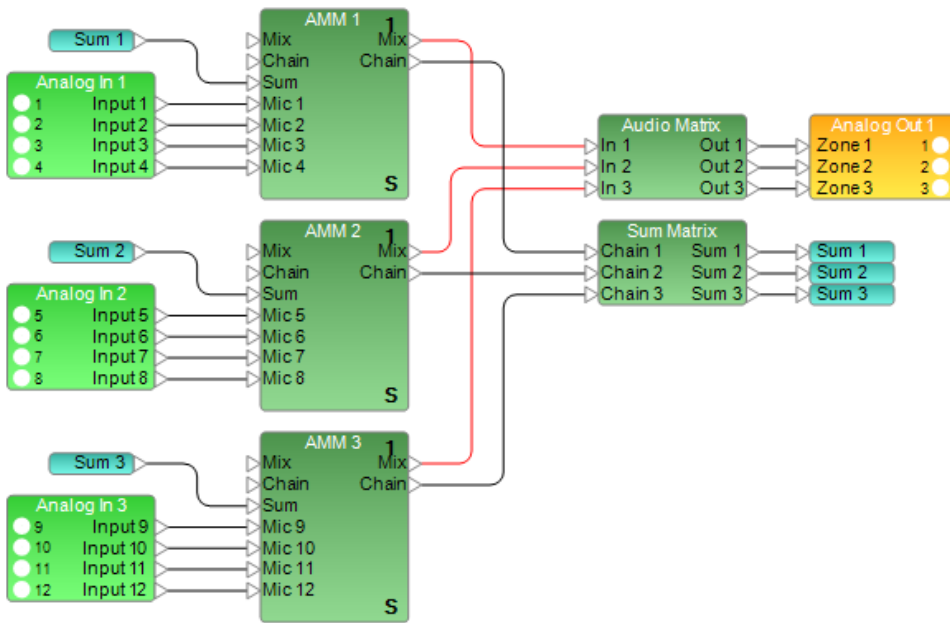

For clarity, 2 separate matrix mixers are used. One for the audio routing and one for the sum route.

By default the routing is 1:1.

This means that AMM 1 only receives the sum of its own 4 microphones.

And this is the same for AMM 2 and AMM 3.

To recall this later, add both Matrix mixers into a Parameter set.

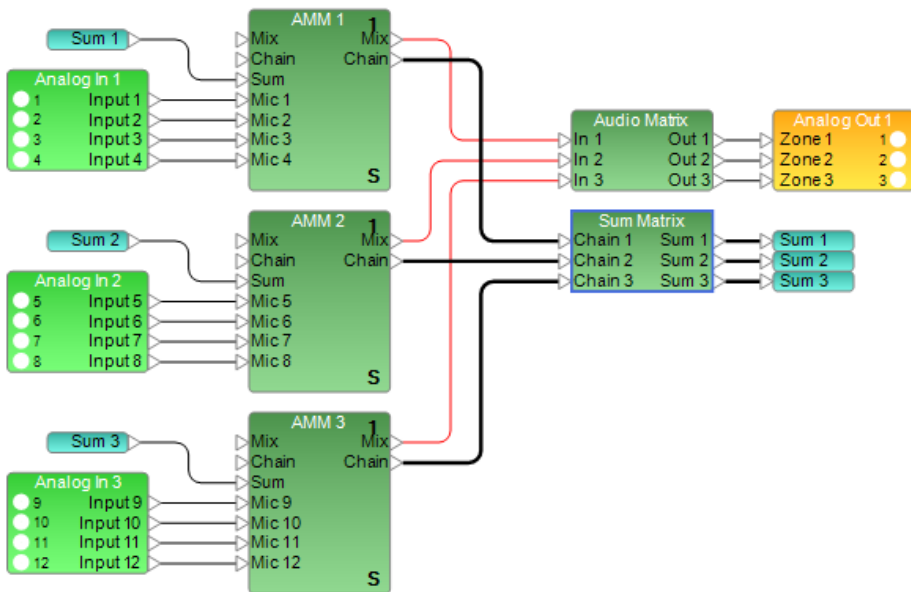

Matrix
EX-1280C 1: Audio Matrix

		Out:		
		Out 1	Out 2	Out 3
In:		1	2	3
In 1	1	0.0	0.0	0.0
In 2	2	0.0	0.0	0.0
In 3	3	0.0	0.0	0.0

Matrix
EX-1280C 1: Sum Matrix

		Out:		
		Sum 1	Sum 2	Sum 3
In:		1	2	3
Chain 1	1	0.0	0.0	0.0
Chain 2	2	0.0	0.0	0.0
Chain 3	3	0.0	0.0	0.0

To combine Zone 1 and Zone 2, change the routing of both Matrix mixers as shown below.

Now the Sum of Zone 1 and Zone 2 (sum of microphone 1-8) will be sent to AMM 1 and AMM 2. Both AMMs can calculate the gain per channel and AMM 1 and AMM 2 Mix outputs will be mixed together.

AMM 3 will function independent as it does not get any information from AMM 1 or AMM 2

To recall this later, add both Matrix mixers into a Parameter set.

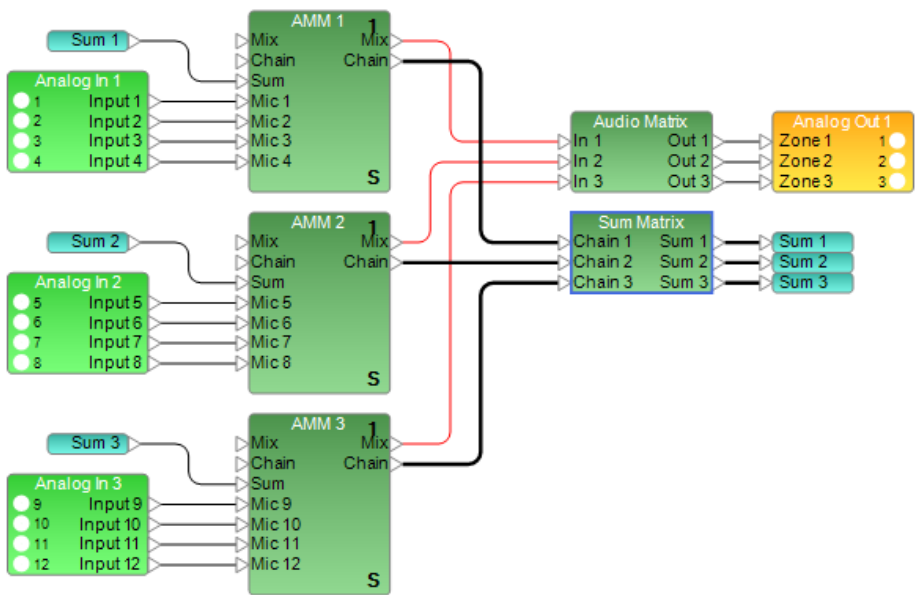

Matrix
EX-1280C 1: Audio Matrix

In:		Out:		
		Out 1	Out 2	Out 3
In 1	1	0.0	0.0	0.0
In 2	2	0.0	0.0	0.0
In 3	3	0.0	0.0	0.0

Matrix
EX-1280C 1: Sum Matrix

In:		Out:		
		Sum 1	Sum 2	Sum 3
Chain 1	1	0.0	0.0	0.0
Chain 2	2	0.0	0.0	0.0
Chain 3	3	0.0	0.0	0.0

To combine all zones, select all cross-points in both Matrix mixers.

The Sum of Zone 1, Zone 2 and Zone 3 (sum of microphone 1-12) will be sent to AMM 1, AMM 2 and AMM 3. All AMMs can calculate the gain per channel.

To recall this later, add both Matrix mixers into a Parameter set.

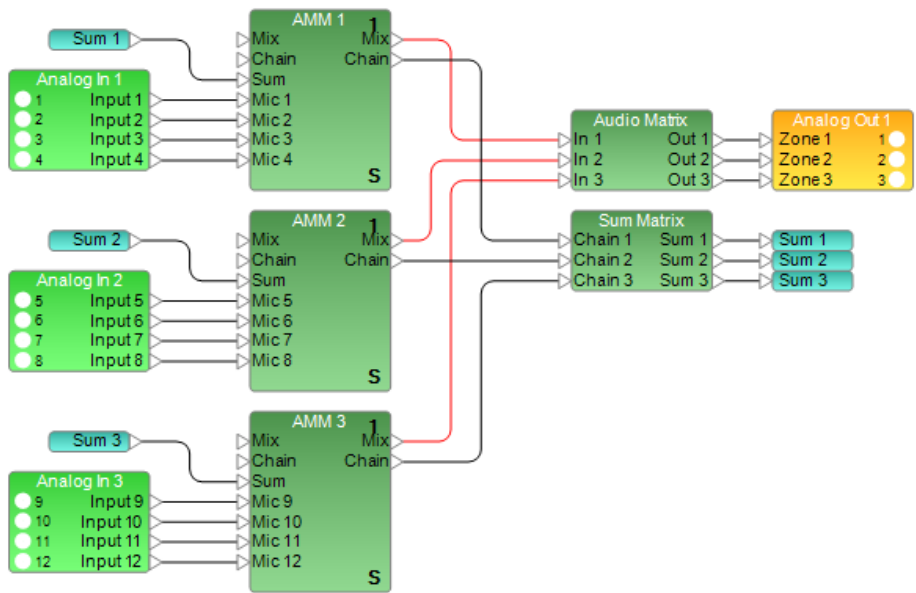

Matrix
EX-1280C 1: Audio Matrix

In:		Out:		
		Out 1	Out 2	Out 3
In 1	1	0.0	0.0	0.0
In 2	2	0.0	0.0	0.0
In 3	3	0.0	0.0	0.0

Matrix
EX-1280C 1: Sum Matrix

In:		Out:		
		Sum 1	Sum 2	Sum 3
Chain 1	1	0.0	0.0	0.0
Chain 2	2	0.0	0.0	0.0
Chain 3	3	0.0	0.0	0.0

Compressor/Limiter

Compressor/Limiter processing reduces the level of an input signal when it reaches a predetermined threshold. Both a monaural Compressor/Limiter with one input and a side-chain input, and a stereo Compressor/Limiter with stereo inputs and a side-chain input are supported.

Control panels for mono and stereo versions differ only in the choice of input trigger signals.

Double-click on the Compressor/Limiter block in Signal Processing View to open its control panel.

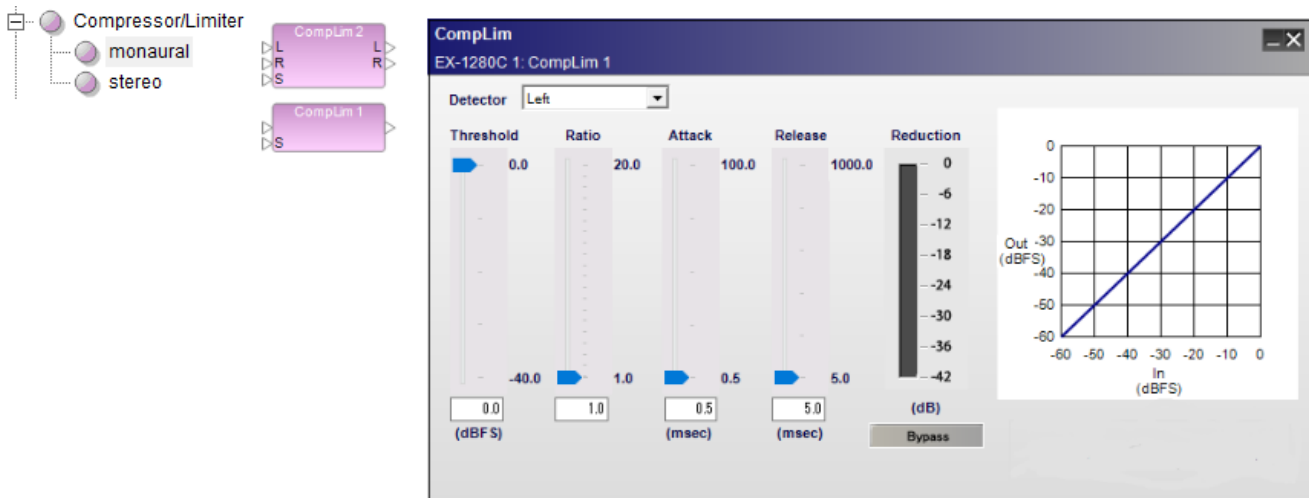

Stereo Compressor/Limiter processing block and control panel

The Compressor/Limiter control panel provides the following options:

Detector – determines which incoming signal is sent to the detector circuit (or trigger) to activate the signal processing.

Input - (mono only) indicates the input signal is the trigger for processing.

Left - (stereo only) indicates the left signal is the trigger for processing.

Right - (stereo only) indicates the right signal is the trigger for processing.

Mix - (stereo only) indicates a left/right signal mix is the trigger for processing.

Side-chain - indicates an alternate signal connected to the side-chain input is the trigger for signal processing.

Threshold slider – determines the level of the detector signal at which the processing block will begin adjusting the input signal. When the signal drops below this threshold, the input signal is not affected by the processing block.

Threshold gain value – is entered directly into the box. The range of adjustment is -40 to 0 dBFS (default) and tracks the threshold slider setting.

Ratio slider – establishes an input/output ratio for signals above the threshold. Signals exceeding the threshold are reduced by an amount according to the ratio. For example, when using a compression ratio of 10:1, a 10dB change in the input level results in only a 1dB change at the output of the processor for all signals above the threshold level setting.

Ratio value – is entered directly into the box. The range of adjustment is 1.0 (default) to ∞ and tracks the threshold slider setting.

Attack slider – establishes the rate in milliseconds at which input signals are processed once they exceed threshold.

Attack value – is entered directly into the box. The range of adjustment is from 0.5 milliseconds (default) to 100 milliseconds.

Release slider – determines the rate in milliseconds when signal processing is discontinued after threshold is exceeded.

Release value – is entered directly into the box. The range of adjustment is from 5 milliseconds (default) to 1000 milliseconds.

Reduction meter – displays a vertical bar level indicator to illustrate the amount of signal reduction applied based upon the currently defined processing values.

Bypass – forces the channel to remain open at all times by circumventing the detection circuitry.

Compressor/Limiter graph - illustrates the input level versus the output level of the signal in a graphical manner. The slope of the line indicates the compression ratio.

Conference Room Router

About Conference Room Router and Combiner

The Conference Room Router (CRR) / Conference Room Combiner (CRC) is a signal processing block for conference room applications. It provides the routing processing necessary to fully implement a conference room solution.

NOTE: The EX-1280C sound processor supports use of the CRR and room combining. However, the ESP sound processors do not support CRR or room combining features.

Conference Room Router

A CRR block comprises both matrices and gain elements. In the CRR block, you configure inputs and outputs for specific purposes and routing and gain parameters are set accordingly.

In a CRR block, you can:

- Define the I/O configuration with the CRR Wizard.
- Adjust several volume controls (which include gain and mute) via the CRR control panel.
- Edit cross-points related to the speaker outputs via a Speaker Matrix.
- Edit CRR routing cross-points via the Advanced Matrix View.
- Disable or enable incoming audio (voice lift) from combined rooms via the Advanced Matrix View.

Combining Rooms

You can combine a CRR block with other CRR blocks by registering them in the same RC (Room Combiner) Group. Up to six CRR blocks can be combined.

For more information on using CRR and CRC, see:

[Configuring a Single CRR](#)

[Configuring Combined Rooms](#)

[CRR Block Input and Output Ports](#)

[CRR Control Panels](#)

[Room Combine Layout and Room Combine Control Panels](#)

[CRR Speaker Matrix](#)

[CRR Functional Block Diagram and Description](#)

[Advanced Matrix View](#)

[Storing CRR Settings in Parameter Sets](#)

[Linking CRR Blocks to Automatic Mic Mixer Blocks](#)

Configuring a Single CRR

Use the CRR Wizard to configure a CRR block for a single room:

1. From the Conferencing section of the SP Tool Kit, drag a Conference Room Router block into Signal Processing View.

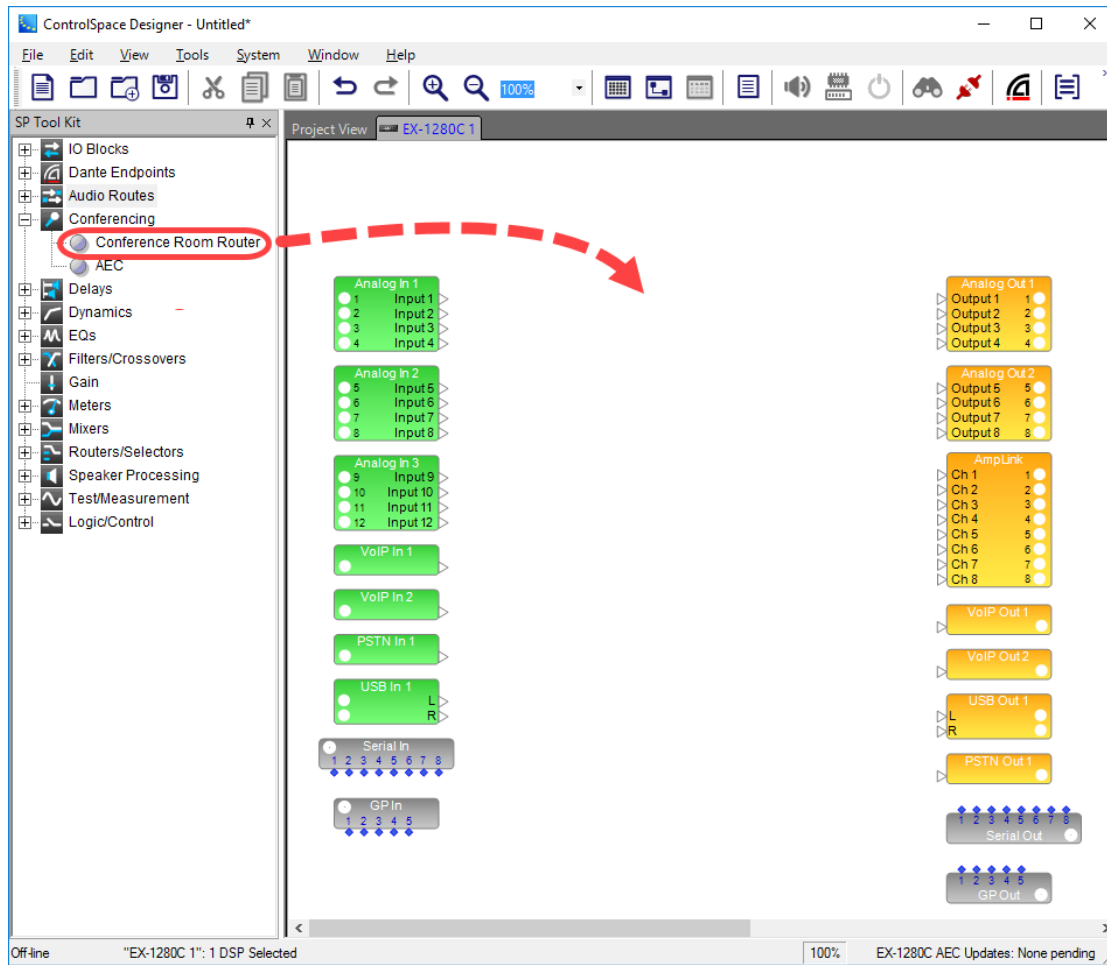

The CRR Wizard displays.

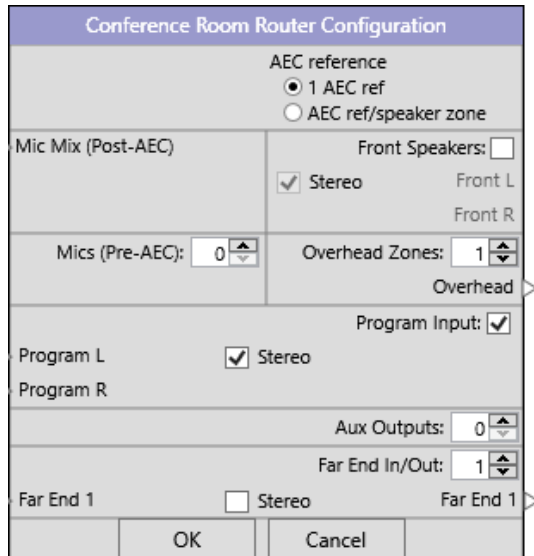

CRR Wizard

2. Set the appropriate CRR options in the wizard:

AEC Reference - for a single AEC reference, select **1 AEC ref**. To configure a separate AEC reference for each speaker zone output (includes front speakers and each overhead zone), select **AEC ref/speaker zone**.

Front Speakers - if you need front speaker output, select this option. If you select the **Stereo** option in this section, the front speaker output becomes stereo.

Mics (Pre-AEC) - specify the number of individual microphones in this section. The minimum is 0 and the maximum is 32.

Overhead Zones - if you need overhead zone outputs, specify the number of zones in this section. The minimum is 0 and the maximum is 16.

NOTES:

- **Overhead Zone is equivalent to Voice Lift zone. To avoid feedback, the signal from the microphone placed in this zone should not be sent to the loudspeaker covering this zone.**
- **You may not define a configuration that does not have both front output and overhead output. If you try to set the number of overhead zones to zero with the Front Speakers option unselected, the front speakers will be selected automatically. If the number of overhead zones is zero and you de-select the Front Speakers option, the number of overhead zones automatically becomes 1.**

Program Input - if you need program input, select this option. If you select the **Stereo** option in this section, the program input becomes stereo.

Aux Outputs - specify the number of auxiliary outputs in this section. The minimum is 0 and the maximum is 8. If you select the **Stereo** option in this section, the auxiliary output becomes stereo.

Far End In/Out - specify the far-end inputs and outputs in this section. The minimum is 0 and the maximum is 8. If you select the **Stereo** option in this section, the far-end input and output becomes stereo.

NOTE : VoIP, PSTN and USB I/O correspond to the far-end I/O.

3. The option labels in the wizard will become the input and output labels in the CRR block. To change an input or output label name in the block, click on the label in the wizard and use standard editing keys to type in a new label name.
4. Click **OK** to add the block to Signal Processing View.

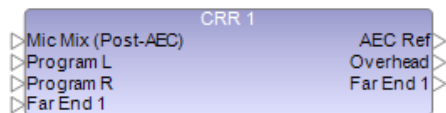

CRR - single block with one AEC reference

For a description of the I/O parameters in the CRR block, see [CRR Block Input and Output Ports](#).

For a description of the controls in the CRR control panel, see [CRR Control Panels](#).

Configuring Combined Rooms

You can combine a CRR block with other CRR blocks by registering them in the same RC (Room Combiner) Group. Up to six CRR blocks can be combined. Each CRR block corresponds to a room and you can define the layout of rooms via the Room Combine Layout control panel. Each room is assigned a room number and you can define the room name in each room. The combination of rooms is controlled via the Room Combine control panel.

To configure combined rooms for conferencing, you must add each CRR block (one per room) to an RCGroup. Up to six CRR blocks, i.e. six rooms, per EX-1280C are supported for room combining.

1. From the Main menu bar, select **Window > RCGroups** to open the RCGroups window. Alternatively, you can click the RCGroups toolbar button .

- Drag and drop the CRR block into the RCGroup. Alternatively, you can right-click the CRR block, select **Add to RCGroup**, and select the RCGroup in which to include the CRR block.

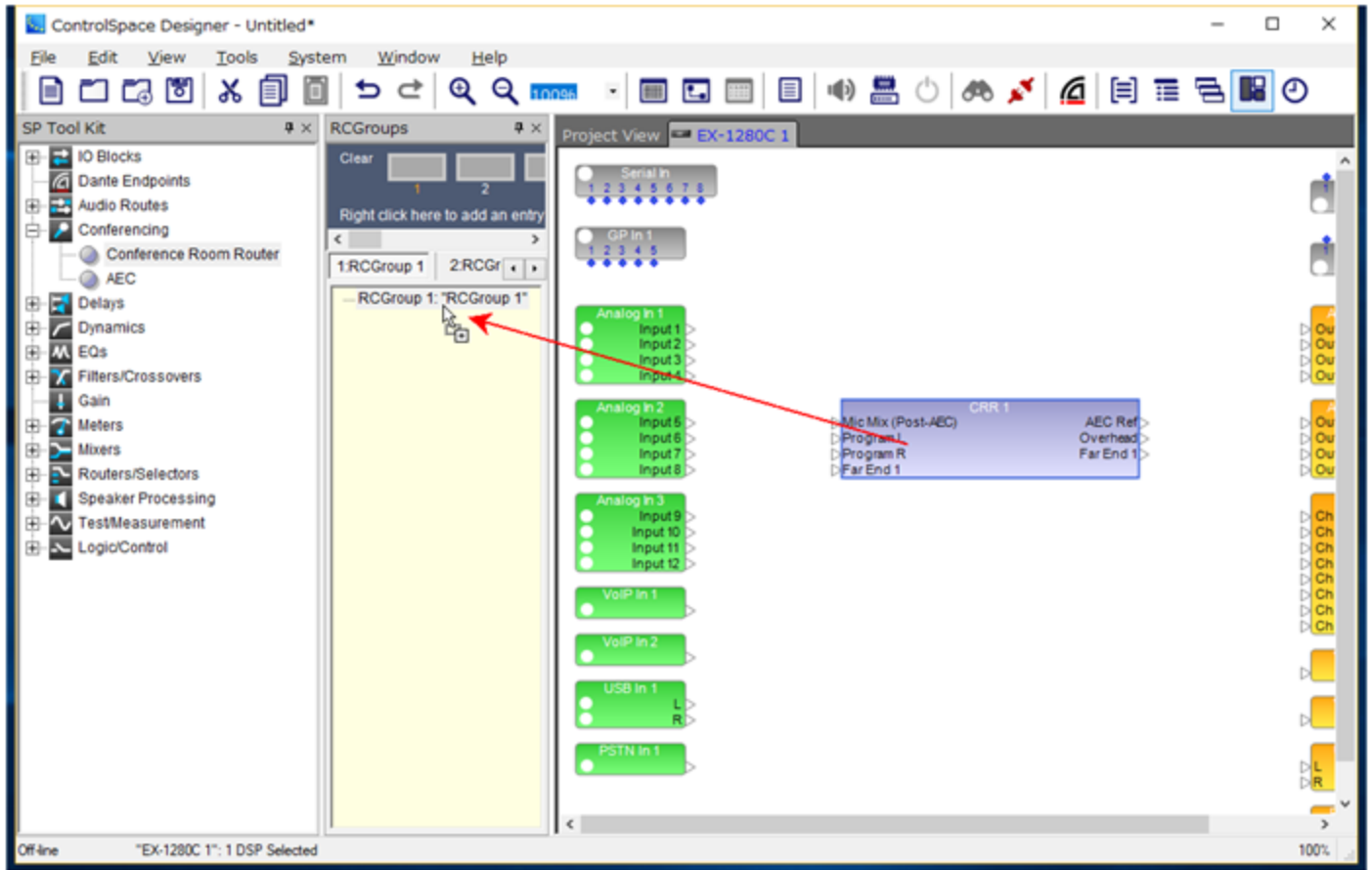

CRR - dragging block into RCGroup

After multiple CRR blocks are registered in the RCGroup, input ports and output ports for connecting to each CRR are automatically added to the CRR block.

For example, in the case of two CRRs registered to the RCGroup, the following ports are added to CRR 1, where 2 is the room number of the other CRR block to be combined (CRR2):

- Input side - AMM Chain, RC 2 Mics, RC 2 PreMics, RC 2 NonMics L, RC 2 NonMics R, and RC 2 Chain
- Output side - AMM Sum, RC Mics, RC PreMics, RC NonMics L, RC NonMics R, and RC Chain

NOTE: If the number of Mics (Pre-AEC) is zero, there will be no RC *n* PreMics or RC PreMics ports.

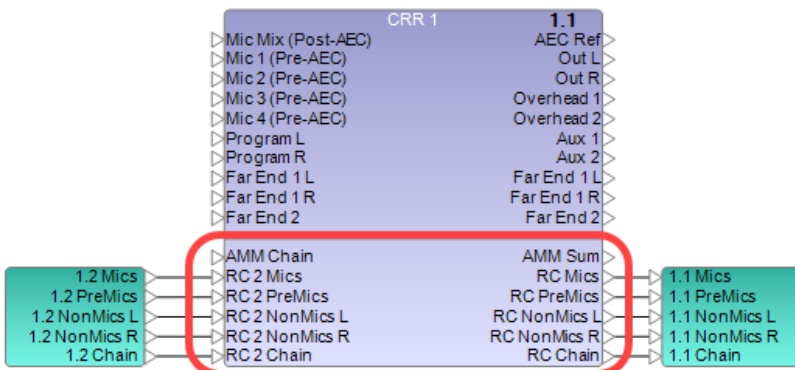

CRR 1 - example of ports added in combined multiple blocks

Corresponding ports are added to CRR2 where n is the room number of the other CRR block (1 in this case).

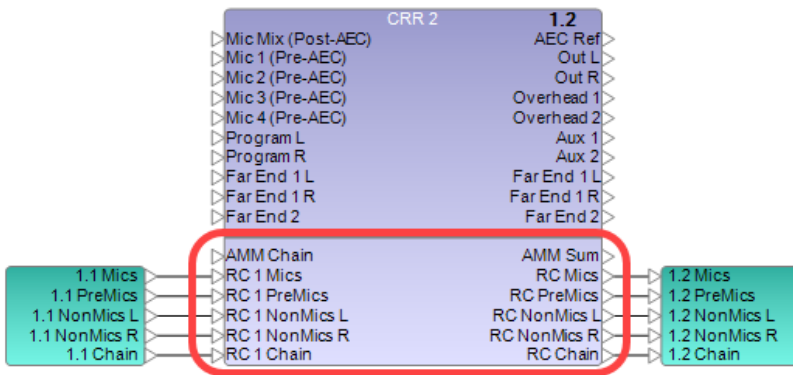

CRR 2 - corresponding ports when combined with CRR1

Audio routes (or Dante audio routes for multiple EX-1280C systems) are automatically added by CSD to connect the appropriate RC I/O ports between combined CRR blocks.

For more information on:

- Ports and audio routes that are added when CRRs are placed in the same RCGroup, see [CRR Ports in RCGroups](#).
- I/O ports and parameters in a CRR block, see [CRR Block Input and Output Ports](#).
- Controls in the CRR control panel, see [CRR Control Panels](#).
- Room Combine Layout and Room Combine control panels, see [Room Combine Layout and Room Combine Control Panels](#).
- RCGroup functions, see [RCGroups](#).

Removing a CRR Block from an RC Group

You can remove a CRR block from an RC Group using either of these methods:

- Right click on the target CRR block in the RCGroup window and select **Delete**.

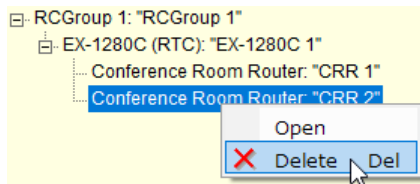

- Select the target CRR block in the RCGroup window and press the **Delete** key.

CRR Block Input and Output Ports

This topic describes the I/O ports in a CRR block. The following example of a CRR combined block is referenced in some of the I/O descriptions:

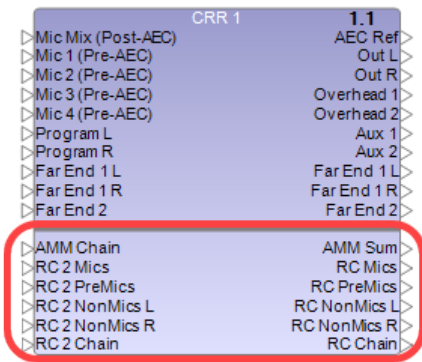

CRR - example of combined multiple blocks

CRR Input Ports

Mic Mix (Post-AEC) - input for the mix of microphone signals. The signal from this input is sent to the auxiliary outputs, far-end outputs, and RC Mics output. **Note:** Use Mic Mix (Post-AEC) when microphone inputs are processed by the AEC and the AMM.

In the following example, four microphones are connected to analog inputs and analog output 1 is connected to a loudspeaker via a power amplifier. Because microphone signals are not sent to the Front output, they are not outputted from the loudspeaker.

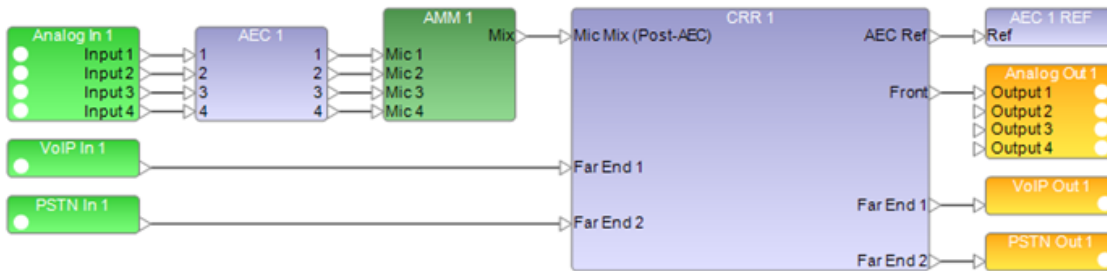

CRR - example of Mic Mix (Post-AEC)

Mic n (Pre-AEC) - input for the individual microphone signals. The signal from this input can be sent to the front speaker output and overhead zone outputs by turning on the cross-point of the **CRR Speaker Matrix**. **NOTE: Use Mic n (Pre-AEC) when you need to send microphone signals to the speaker outputs.**

In the following example, four microphones are connected to analog inputs, and analog output 1 is connected to a loudspeaker via a power amplifier. Microphone signals that are inputted to Mic Mix (Post-AEC) are sent to the far-end outputs, and microphone signals that are inputted to Mic n (Pre-AEC) are sent to the overhead zone output. Since the signal processing of the AEC involves propagation delay, this connection is recommended. Additionally, insert an AMM block between the analog input block and Mic n (Pre-AEC) inputs.

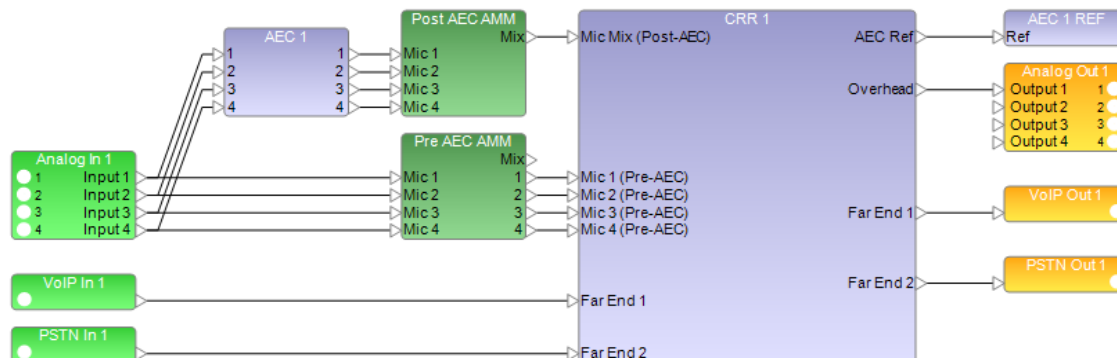

CRR - example of Mic Mix (Pre-AEC)

Program - input for the program source such as a DVD player. The signal from this input is sent to the AEC Ref output(s), auxiliary outputs, far-end outputs, and RC NonMics output. The signal from this input can also be sent to the front speaker output and overhead zone outputs by turning on the cross-point of the Speaker Matrix. This input can be stereo - it is defined in the **CRR Wizard**.

Far End input - input for the far-end device. The signal from this input is sent to the AEC Ref output(s), auxiliary outputs, far-end outputs (except the output that has the same ID number as the input), and the RC NonMics output. The signal from this input can also be sent to the front speaker output and overhead zone outputs by turning on the cross-point of the Speaker Matrix. This input can be stereo - it is defined in the CRR Wizard. **Note:** To prevent feedback, this input signal is not sent to the output that has the same ID number as this input.

AMM Chain - input for connecting with the Chain output of the AMM. The signal from this input is sent to the AMM Sum output and the RC Chain output. Leave this input open if you are not using an AMM in combination with the CRR.

RC n Mics - input for the microphone signal output from the room to be combined. n represents the room number of the room to be combined. This input is switched ON (unmuted) when the room is combined, and OFF (muted) when the room is not combined. By default, when the input is ON, the signal from this input is sent to the auxiliary outputs and far-end outputs. This routing can be changed in the Advanced Matrix View.

RC n PreMics - input that receives the mix of Pre-AEC Mics from the room to be combined. n represents the room number of the room to be combined. This input is switched ON (unmuted) when the room is combined, and OFF (muted) when the room is not combined. By default, when the input is ON, the signal from this input is sent to the overhead zone outputs. This routing can be changed in the Advanced Matrix View.

RC n NonMics - input for non-microphone signal output from the room to be combined. n represents the room number of the room to be combined. This input is switched ON (unmuted) when the room is combined, and OFF (muted) when the room is not combined. By default, when the input is ON, the signal from this input is sent to the AEC Ref output(s), auxiliary outputs, and far-end outputs. This routing can be changed in the Advanced Matrix View. When the room is combined, this signal is also sent to the overhead zone outputs. If no overhead zone outputs are available, this signal will be sent to the front speaker output. This can be changed using the Speaker Matrix, or the Advanced Matrix view.

RC n Chain - input for the RC Chain output from the room to be combined. n represents the room number of the room to be combined. The signal from this input is sent to the AMM Sum output when the room is combined. If the room is not combined, the signal from this input is not sent anywhere.

CRR Output Ports

AEC Ref - output for the reference input of the **Acoustic Echo Cancellation - AEC** block. If you are using multiple AEC references, one for each speaker zone, then the AEC Ref outputs are separately labeled **AEC Ref F** (for the front speaker zone) and **AEC Ref 1**, **AEC Ref 2**, and so on for each overhead speaker zone. Connect these outputs to the Ref inputs of the respective AEC blocks, if used. Leave these outputs open if you do not use AEC blocks.

When you are using a single AEC reference, the following input signals are sent to this output:

- Program input
- Far End input
- RC n NonMics input (only when the room is combined)

When you are using multiple AEC references, the following input signals are sent to these outputs:

- Program input
- Far End input

- RC n NonMics input (only when the room is combined)
- Mic n (Pre-AEC), only when Mic n (Pre-AEC) signal is sent to the corresponding speaker zone

Front - output for the front speaker. This output can be stereo - it is defined in the CRR Wizard. You can set routing of the following input signals for this output, using the Speaker Matrix:

- Mic n (Pre-AEC) input
- Program input
- Far End input
- RC n NonMics input (only when the room is combined)

Overhead - output for the overhead zone. You can set routing of the following input signals for this output, using the Speaker Matrix:

- Mic n (Pre-AEC) input
- Program input
- Far End input
- RC n PreMics input (only when the room is combined)
- RC n NonMics input (only when the room is combined)

Aux - auxiliary output. Aux can be used for various purposes. This output can be stereo - it is defined in the CRR Wizard. The following input signals are sent to this output:

- Mic Mix (Post-AEC)
- Program input
- Far End input
- RC n Mics input (only when the room is combined)
- RC n NonMics input (only when the room is combined)

Far End - output for the far-end device. This output can be stereo - it is defined in the CRR Wizard. The following input signals are sent to this output:

- Mic Mix (Post-AEC)
- Program input
- Far End input (except the input which has the same ID number as this output)
- RC n Mics input (only when the room is combined)
- RC n NonMics input (only when the room is combined)

AMM Sum - output for connecting with Sum input of AMM. The following input signals are sent to this output:

- AMM Chain
- RC n Chain (only when the room is combined)

Leave this output open if you do not use an AMM in combination with the CRR.

RC Mics - output for microphone signal input of the room to be combined. Mic Mix (Post-AEC) input signal is sent to this output. This output signal should be connected to RC n Mics input of all CRR blocks to be combined (n represents the room number of this CRR block).

RC PreMics - output for sending the mix of Pre-AEC Mics to the room to be combined.

RC NonMics - output for the non-microphone signal input of the room to be combined. The Program input signal and Far End input signals are sent to this output. This output signal should be connected to the RC n NonMics input of all CRR blocks to be combined (n represents the room number of this CRR block). This output becomes stereo when there is stereo on the Program input or Far End inputs.

RC Chain - output for the RC n Chain input of the room to be combined. The AMM Chain input signal is sent to this output. This output signal should be connected to the RC n Chain input of all CRR blocks to be combined (n represents the room number of this CRR block).

CRR Ports in RCGroups

The following I/O ports are displayed when the CRR block is registered in the **RCGroup**.

- AMM Chain
- AMM Sum
- RC Mics
- RC PreMics (appears only if at least one Pre-AEC mic is specified)
- RC NonMics
- RC Chain

The following inputs are displayed when another CRR block to be combined is registered in the same RCGroup:

- RC n Mics
- RC n PreMics (appears only if the other CRR which is connected to the RC input has an RC PreMics output)
- RC n NonMics
- RC n Chain

where n represents the room number of the other CRR block to be combined.

When you register the CRR block in the RCGroup, if there is a CRR block in the RCGroup to be combined, the following I/Os are connected automatically by an **audio route** or **Dante audio route**. You do not need to connect them manually:

- RC n Mics
- RC n PreMics (appears only if the other CRR which is connected to the RC input has an RC PreMics output)
- RC n NonMics
- RC n Chain
- RC Mics
- RC PreMics (appears only if at least one Pre-AEC mic is specified)
- RC NonMics
- RC Chain

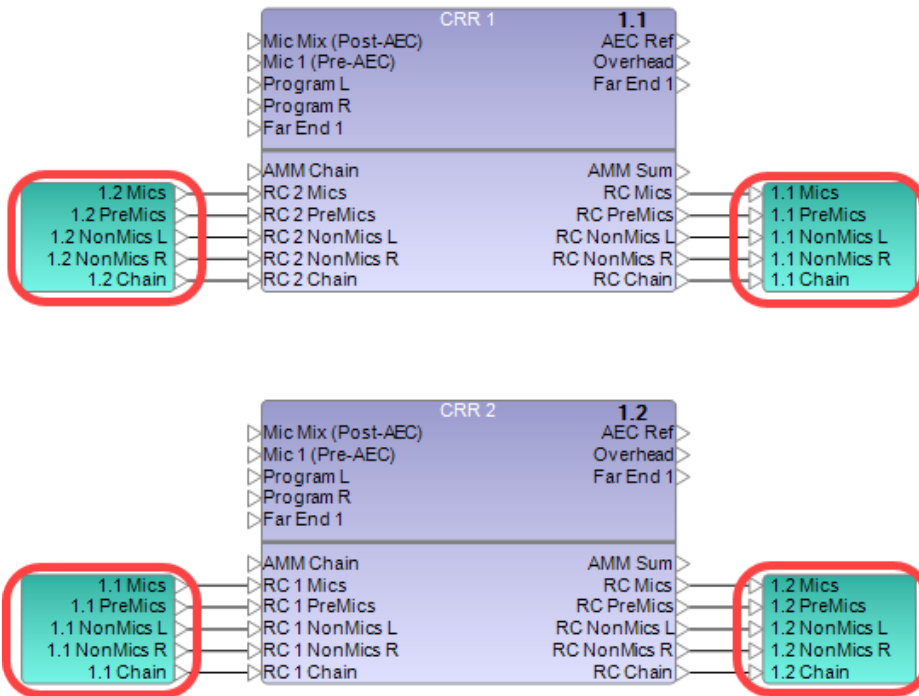

Combined CRRs with audio routing automatically added

NOTE : You can register up to six CRR blocks in one RCGroup. This means that you can combine up to six rooms.

CRR Control Panels

Double click on either the single CRR block or the multiple combined CRR block to display their control panels.

Both single and multiple CRR control panels offer most of the same functions. However, the multiple combined CRR block control panel provides access to room combining functions and other information.

Basic Control Panel for All CRR Configurations

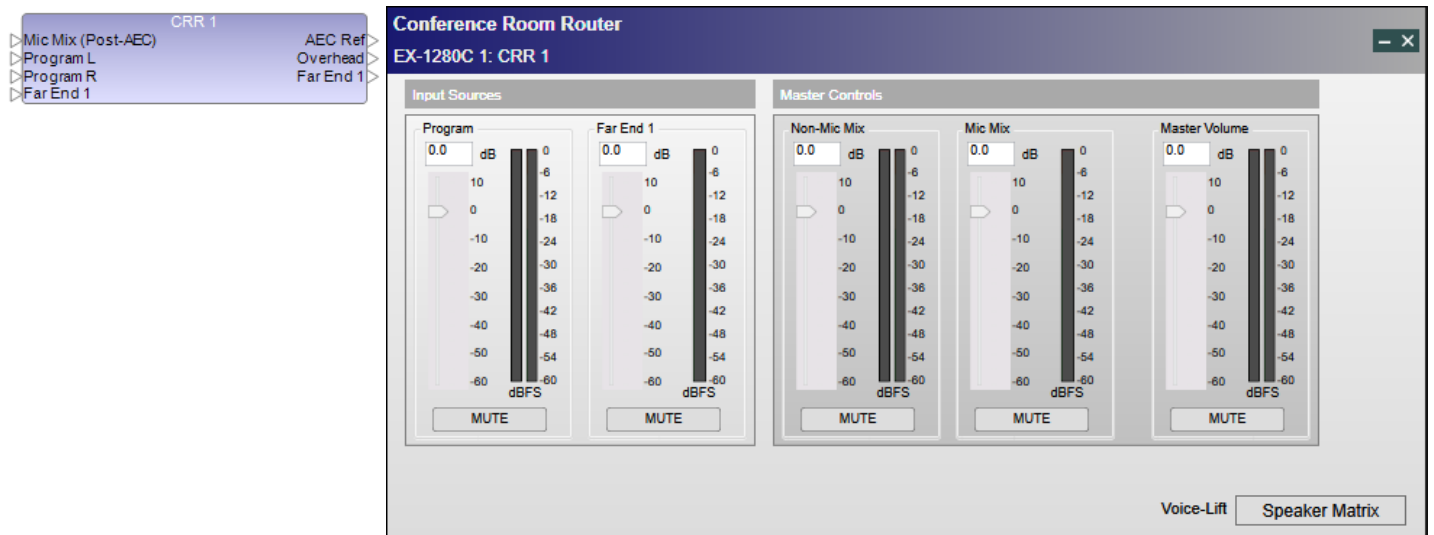

CRR - single block and basic control panel

The basic CRR control panel provides the following controls and level meters:

Volume control - there are volume controls for Input Sources (Program input and each Far End input), respectively:

- Program - Program input
- Far End n - Far End n input

There are also three Master volume controls.

- Non-Mic Mix - Program input, Far End inputs, and RC NonMics inputs
- Mic Mix - Mic Mix (Post-AEC) input and Mic (Pre-AEC) inputs
- Master Volume - Front speaker output, overhead zone outputs and AEC Ref output

Gain slider - determines the gain of the signal. The range of adjustment is from -60 to 12 dB. Default is 0 dB.

Gain value - is entered directly into the text box. Tracks the Gain slider setting.

Level meters - are displayed in the area of volume controls. Each meter indicates the level of the corresponding signal.

Mute button - determines whether the signal is muted. When the mute is turned on, this button turns red. When the mute is turned off, this button turns gray. The default setting is unmuted.

When rooms are combined, volume controls of Non-Mic Mix are synchronized with those of the combined CRR blocks. This synchronization also applies to the Mic Mix and Master Volume volume controls. The following rules apply to volume control synchronization:

- Mute - When the rooms are combined, if there is a muted volume control, the corresponding volume control of all combined CRR blocks will also be muted. When one of mute settings is changed, the mute state of all combined CRR blocks will also reflect that change.
- Gain - When the rooms are combined, the gain of the volume control is adjusted to the lowest setting. When one of gain settings is changed, the gain of all combined CRR blocks will also reflect that change.

Speaker Matrix - opens the **CRR Speaker Matrix**. Note that this button is only available when the CRR's Matrix Mode is set to **Normal**.

Advanced Matrix(not shown) - opens the **Advanced Matrix View**. Note that this button replaces the Speaker Matrix button when the CRR's Matrix Mode is set to **Advanced**.

Control Panel for Multiple Combined CRR Configurations

The screenshot shows the 'Conference Room Router' interface for 'EX-1280C 1: CRR 1'. It features two main sections: 'Input Sources' and 'Master Controls'. Each section contains three volume sliders with level meters and MUTE buttons. The 'Input Sources' sliders are for Program, Far End 1, and Far End 2. The 'Master Controls' sliders are for Non-Mic Mix, Mic Mix, and Master Volume. Below these is a 'Room Combine Control Panel' with fields for Group (1), Room # (1), and Room Name (CRR 1). At the bottom right are 'Voice-Lift' and 'Speaker Matrix' buttons. On the left, a tree view shows the CRR 1 configuration, with a red box highlighting the AMM Chain and RC Mics/PreMics/NonMics/Chain items.

CRR - combined multiple block control panel

This offers the same functionality as the basic control panel, with these additional options:

Room Combine Control Panel button - opens the **Room Combine control panel or the Room Combine Layout control panel**.

Group - displays the number of RCGroup to which this particular CRR block belongs.

Room # - displays the room number of this particular CRR block. **NOTE: The room number is assigned automatically when you register the CRR block to the RCGroup.**

The number of RCGroup and the room number are also displayed in the upper right corner of the block as *RCGroup#.Room#*. In the following example, the number of the RCGroup is 1 and the room number is 2 (1.2).

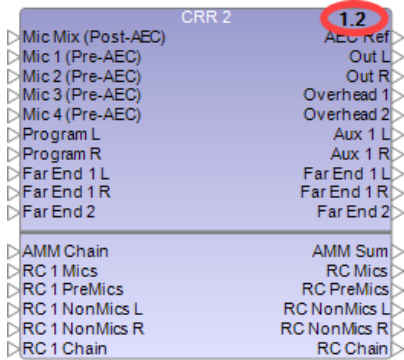

Room name - displays the name of the room. You can edit the name of the room on Room Combine Layout control panel.

Room Combine Layout and Room Combine Control Panels

Click the **Room Combine Control Panel** button in the CRR control panel for one of the CRRs in the RCGroup to either define the room layout or access the Room Combine control panel. If you have not defined the room layout yet, the Room Combine Layout control panel opens. If you have already defined the room layout, the Room Combine Control Panel opens.

Room Combine Layout Control Panel

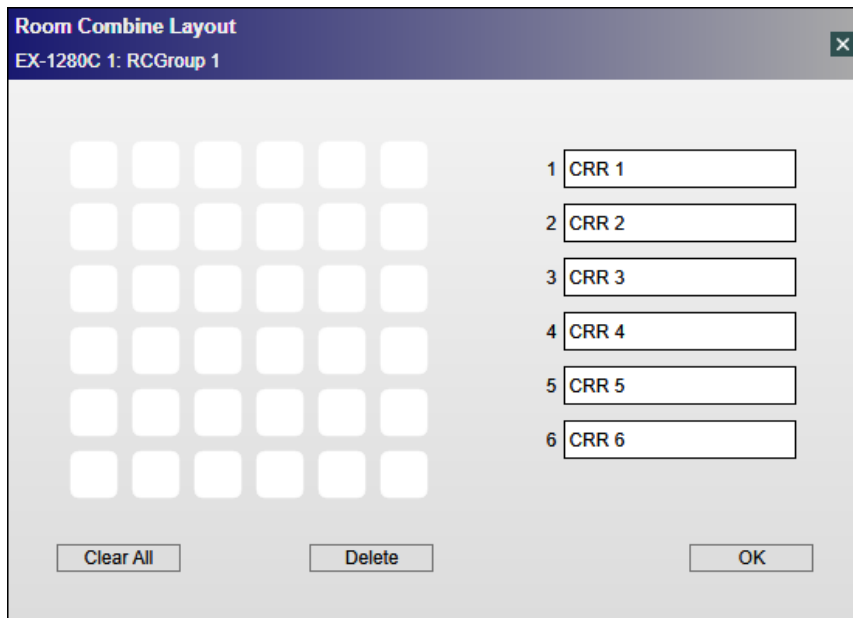

Room Combine Layout control panel for undefined layout

Room Labels

Each CRR in the RCGroup is listed on the right by number. The room names are assigned consecutively by default as CRR 1, CRR 2, CRR 3, and so on. You can change any of these room labels using standard editing key functions.

Room Layout

To create and edit a layout:

1. Click a white square to designate each room in consecutive order (you will be able to modify the layout later). The first square you select is designated 1 (for CRR1), the second 2 (for CRR2), and so on.

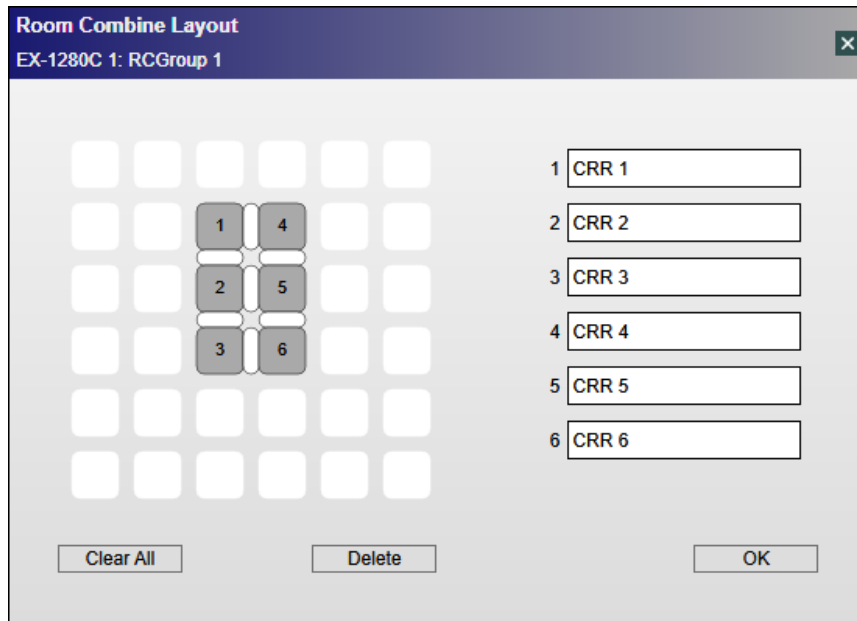

Room Combine Layout control panel, with a six-room layout

2. You can expand a room by clicking the border between it and another square.

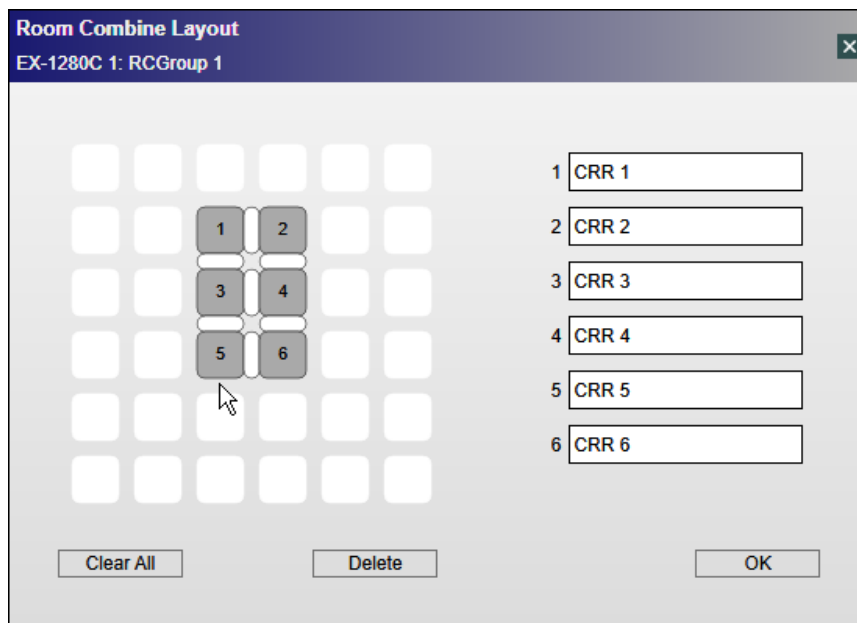

Cursor placement to expand room 5 to include square below it

The border is removed and the room is now expanded.

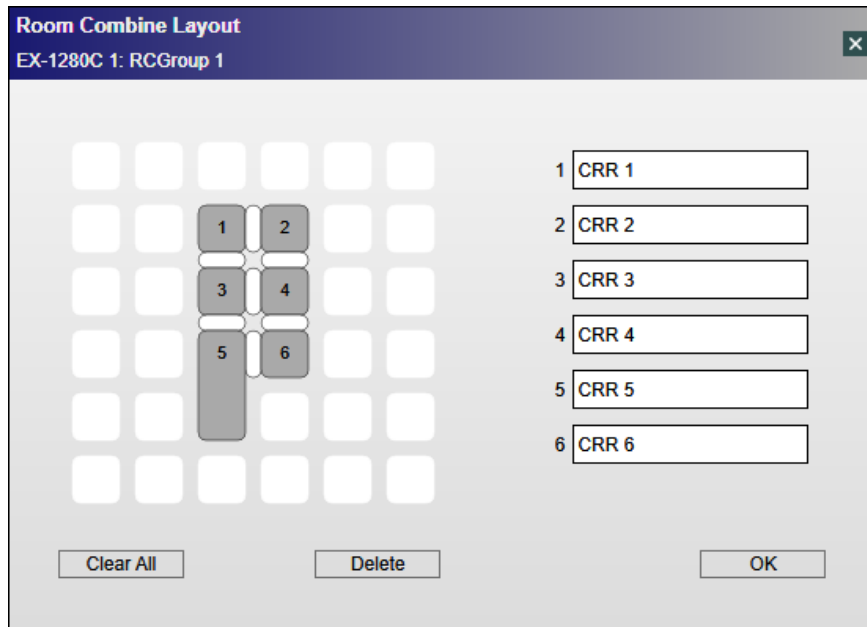

Click border to expand room 5

3. To delete a room, first select it.

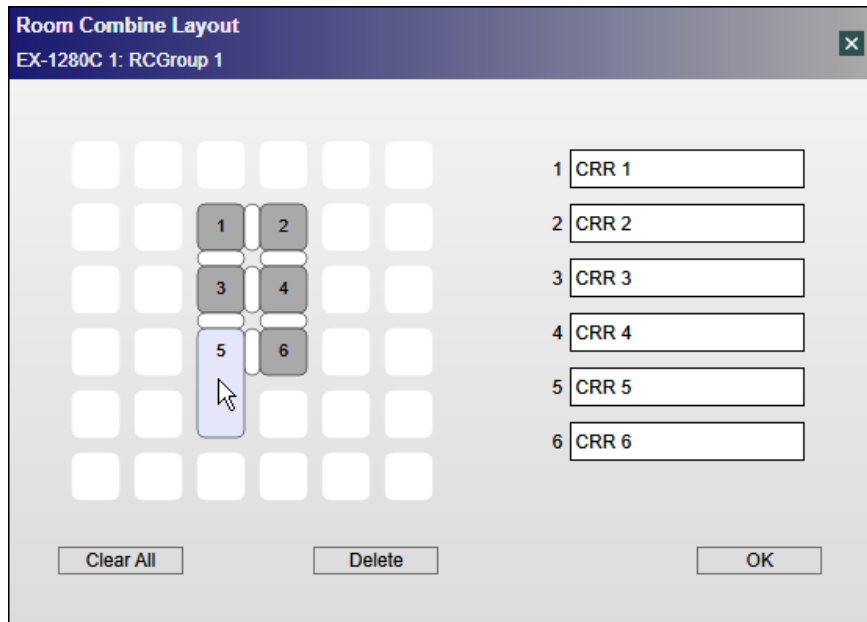

Select a room to delete

4. Click **Delete** to remove the room from the layout.

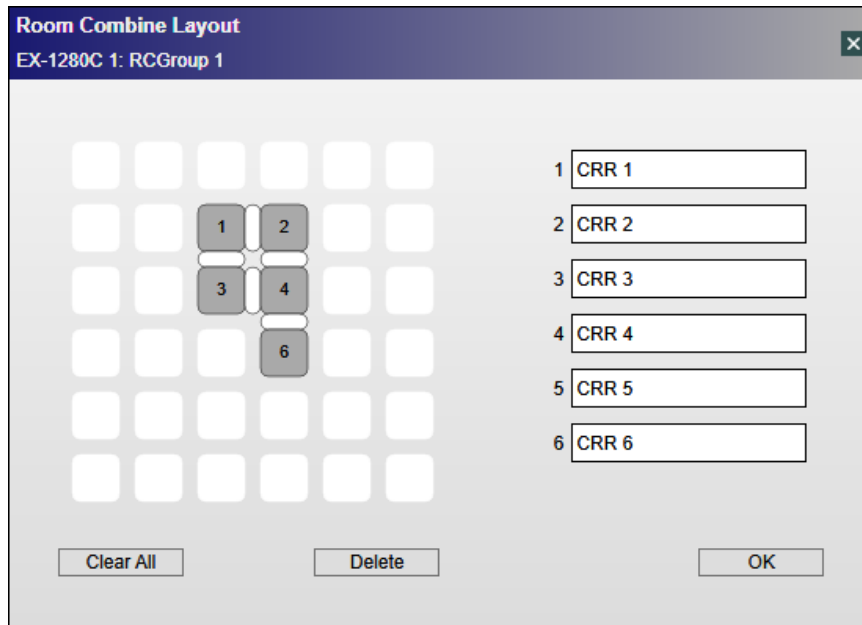

Room 5 removed from layout

Note: To delete all rooms, click **Clear All**.

5. To save the room layout, click **OK**. This opens the Room Combine control panel.

Room Combine Control Panel

Once you have set up the basic room layout, you can use this control panel to combine or separate rooms.

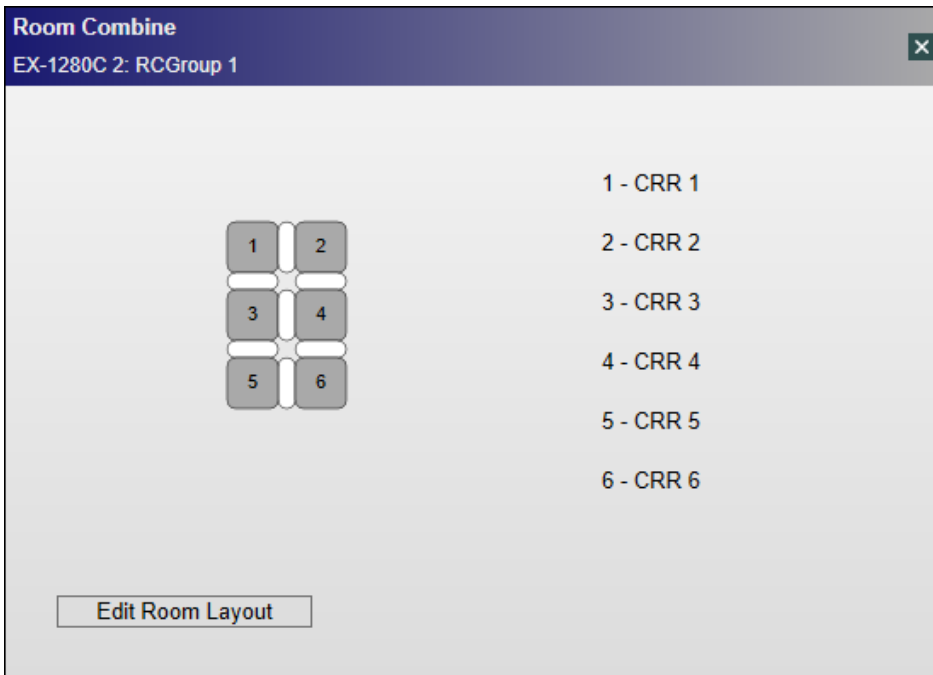

Room Combine control panel

You can combine separate rooms by clicking the wall between them.

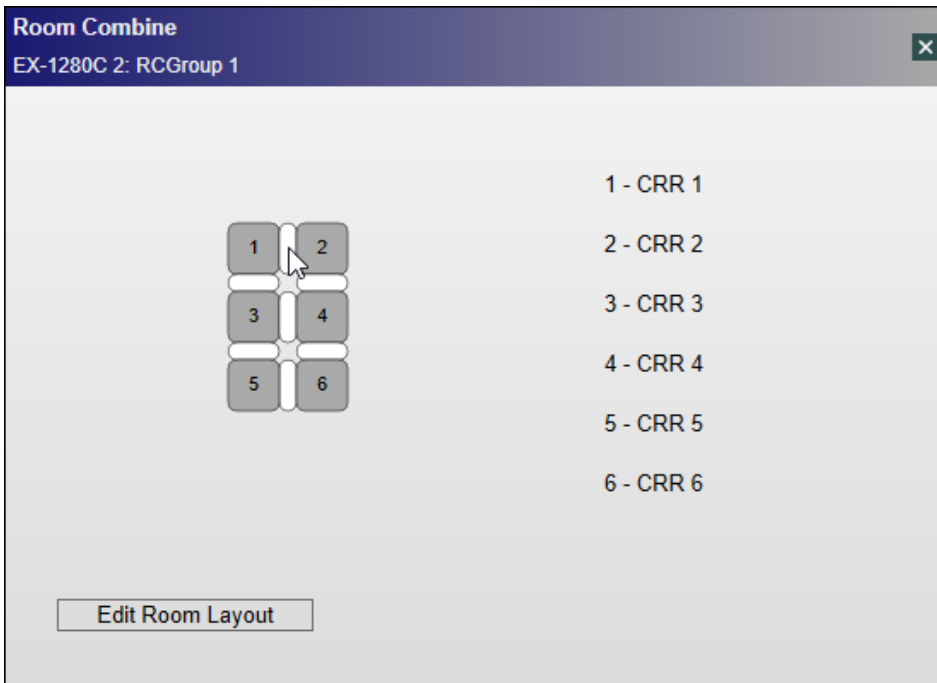

Cursor placement on wall to combine rooms 1 and 2

Rooms are now combined.

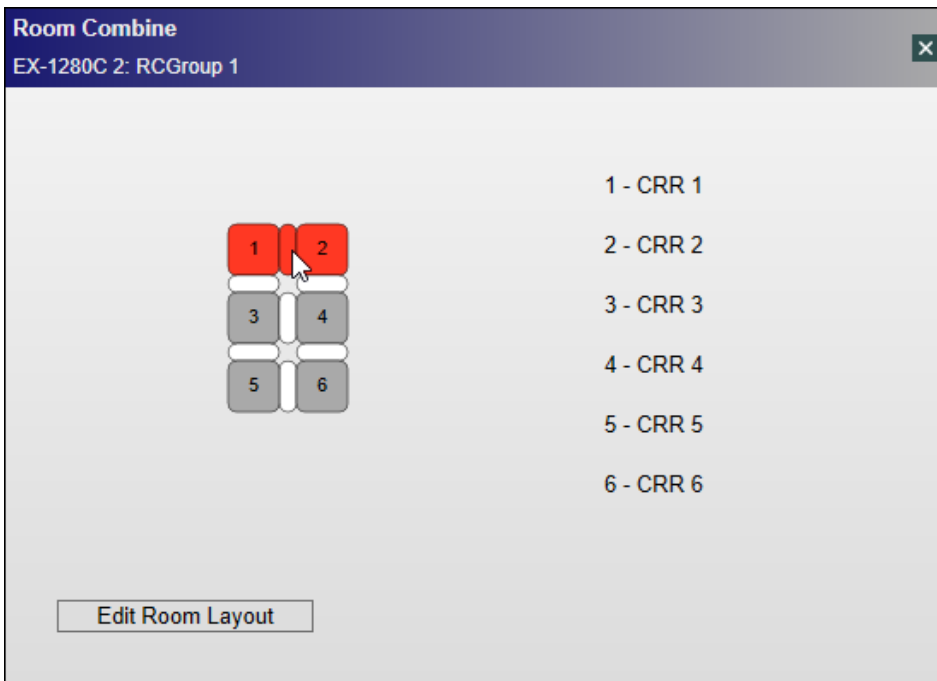

Click wall to combine rooms 1 and 2

Color Coding

Uncombined rooms are always gray. A set of combined rooms always has the same color: red, green, or blue. Each room combination is distinguished by one of those three colors.

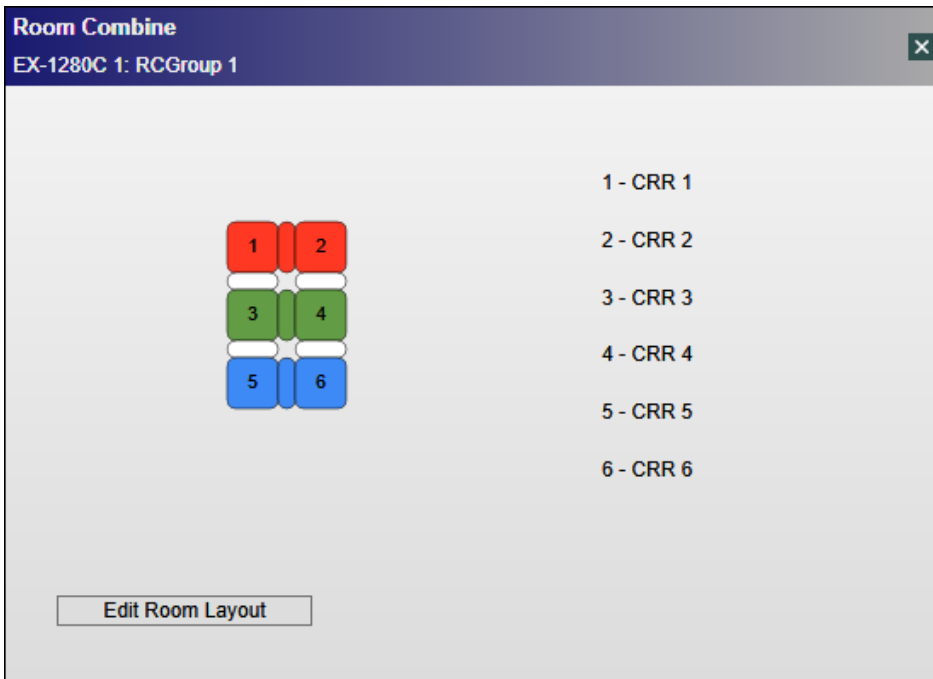

Three sets of combined rooms - distinguished by color

NOTE : To access the Room Combine Layout control panel again, click the Edit Room Layout button. This button only functions when CSD is offline.

CRR Speaker Matrix

Click the **Speaker Matrix** button in the **CRR control panel** to open the Speaker Matrix control panel.

NOTE: Access to the Speaker Matrix control panel is only available when the CRR block's Matrix Mode is set to Normal. To set this mode, right click on the CRR block and select **Matrix Mode > Normal**.

		Out:		
		Overheat	Overheat	Front
In:		1	2	3
Mic 1 (Pre-AEC)	1	0.0	0.0	0.0
Mic 2 (Pre-AEC)	2	0.0	0.0	0.0
Mic 3 (Pre-AEC)	3	0.0	0.0	0.0
Mic 4 (Pre-AEC)	4	0.0	0.0	0.0
Program	5	0.0	0.0	0.0
Far-End	6	0.0	0.0	0.0

Speaker Matrix example - control panel

You can set a cross-point to either On or Off and adjust the gain setting. A cross-point is blue when it is On or gray when it is Off. To change the gain setting, right-click on a cross-point and use the slider control.

The Speaker Matrix control panel contains the following settings:

Mic *n* (Pre-AEC) - same as Mic *n* (Pre-AEC) input. Default setting of the cross-point is Off.

Program - is equivalent to Program input. The default settings are as follows:

- When there are both a front speaker output and overhead zone output, the overhead zone output = Off and the front speaker output = On.
- When there is a front speaker output but no overhead zone output, the front speaker output = On.
- When there is no front speaker output but there is an overhead zone output, the overhead zone output = On.

Far-End - is equivalent to a mix of Far End inputs. The default settings are as follows:

- When there are both a front speaker output and an overhead zone output, the overhead zone output = On and the front speaker output = Off.
- When there is a front speaker output but no overhead zone output, the front speaker output = On.
- When there is no front speaker output but there is an overhead zone output, the overhead zone output = On.

Overhead *n* - same as Overhead *n* output.

Front - same as the front speaker output.

NOTES :

- The Program row and Far-End row are each displayed on one row even if they include a stereo signal. The Front column is displayed on one column even if the front speaker output is stereo.
- If there is at least one local Far-End input and a Program input, RC *n* NonMics follows the Far-End input 1 routing. If there is a Program input but no local Far-End inputs, RC *n* NonMics follows the Program input routing. If there are no Program or Far-End inputs, RC *n* NonMics routes to all speakers.

CRR Functional Block Diagram and Description

The following functional block diagram illustrates the signal processing capabilities of the CRR block:

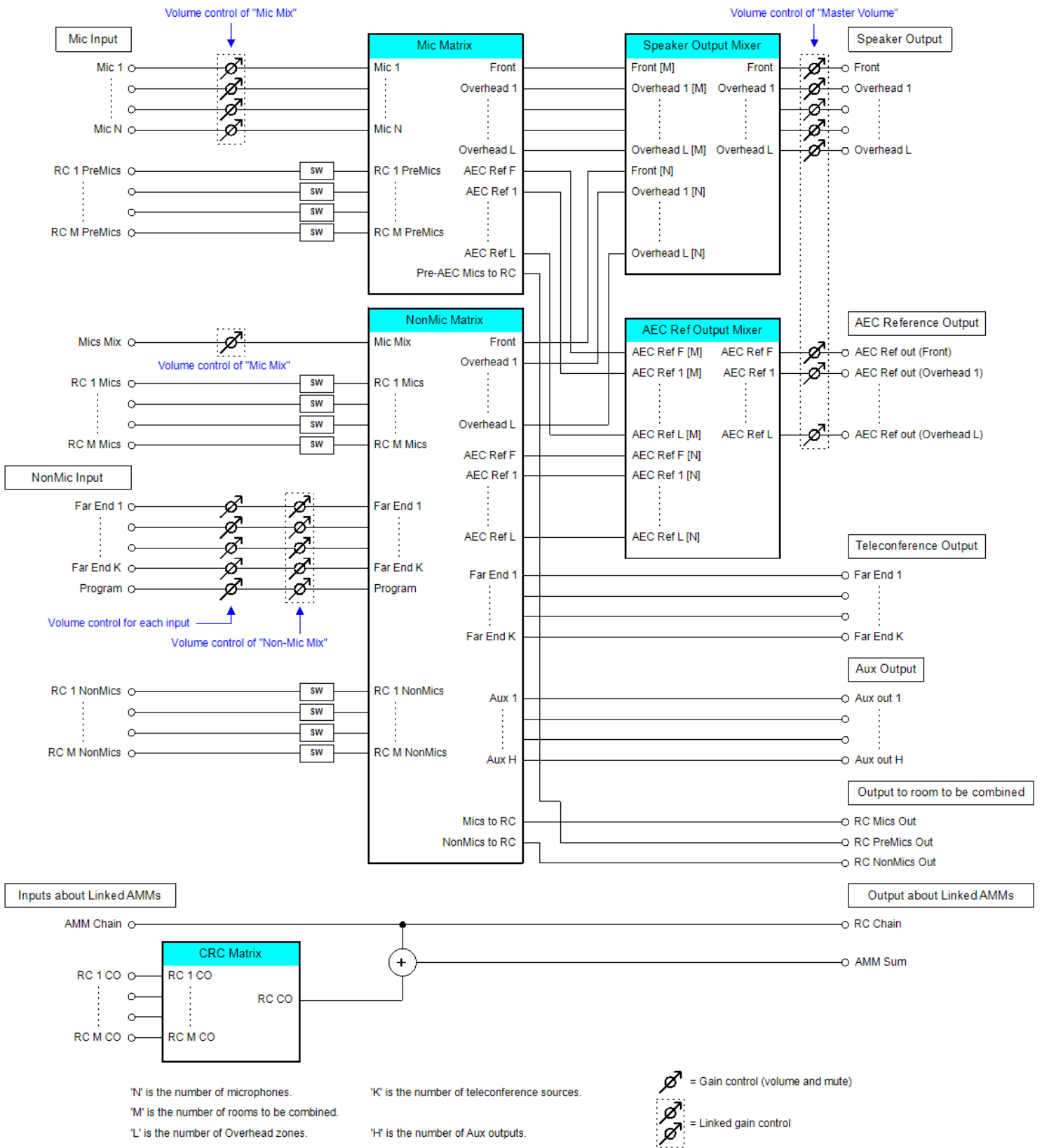

CRR - functional block diagram

NOTE: The RC n CO label in the CRC Matrix in the diagram has since been renamed to RC n Chain in the CRR block.

Mic Matrix - matrix for Mic n (Pre-AEC) and RC n PreMics input. The cross-points of the Mic Matrix for the speaker zones correspond to the cross-points of the Mic n (Pre-AEC) input of the **CRR Speaker Matrix**.

When using a single AEC reference, the AEC Ref F and AEC Ref n outputs are zero.

When using multiple AEC references, AEC Ref F outputs the microphone signals assigned to Front by the Speaker Matrix and AEC Ref n outputs the microphone signals assigned to Overhead n by the Speaker Matrix.

CRC Matrix - matrix for RC n Chain input. When the room corresponding to the RC n Chain input is combined, the cross-point is turned On.

NonMic Matrix - matrix for inputs other than Mic n (Pre-AEC) input and RC n Chain input. It includes the cross-points of the Program and the Far-End in the Speaker Matrix.

Speaker Output Mixer - mixes the outputs of Mic Matrix and a portion of the outputs of NonMic Matrix, as follows:

- Front = Front from Mic Matrix + Front from NonMic Matrix
 - Overhead 1 = Overhead 1 from Mic Matrix + Overhead 1 from NonMic Matrix
 - ...
 - Overhead L = Overhead L from Mic Matrix + Overhead L from NonMic Matrix
- where L is the number of overhead zones

AEC Ref Output Mixer - mixes a portion of the outputs of Mic Matrix and a portion of the outputs of NonMic Matrix.

When you are using a single AEC reference:

- AEC Ref F = AEC Ref F from NonMic Matrix.
This signal is sent to AEC Ref output.

When you are using multiple AEC references:

- AEC Ref F = AEC Ref F from Mic Matrix + AEC Ref F from NonMic Matrix
 - AEC Ref 1 = AEC Ref 1 from Mic Matrix + AEC Ref 1 from NonMic Matrix
 - ...
 - AEC Ref L = AEC Ref L from Mic Matrix + AEC Ref L from NonMic Matrix
- where L is the number of overhead zones

The signal processing performed by Mic Matrix, NonMic Matrix, Speaker Output Mixer, and AEC Ref Output Mixer can be seen in the **Advanced Matrix View**.

Advanced Matrix View

The Advanced Matrix View displays the current state of signal processing routes for all input/output cross-points in a CRR block. You can set a cross-point to either On or Off and adjust the gain setting. A cross-point is blue when it is On or gray when it is Off. To change the gain setting, right-click on a cross-point and use the slider control.

CAUTION : Use care when you turn on a cross-point in the Advanced Matrix View. Some cross-points may cause feedback when turned On.

You can also return the Advanced Matrix View to its **Default Settings**.

To display the Advanced Matrix View:

1. Ensure that the CRR block Matrix Mode is set to Advanced. To do so, right click on the CRR block and select Matrix Mode > Advanced.

- In the CRR control panel, click **Advanced Matrix**.

Default Settings		Out:													
		AEC Ref	Front L	Front R	Overhead	Overhead	Aux 1	Far End	Far End	Far End	RC Mics	RC PreM	RC NonM	RC NonM	
In:		1	2	3	4	5	6	7	8	9	10	11	12	13	
Mic Mix (Post-)	0.0	1	0.0	-3.0	-3.0	0.0	0.0	0.0	-3.0	-3.0	0.0	0.0		-3.0	-3.0
Mic 1 (Pre-AEC)	0.0	2		-3.0	-3.0	0.0	0.0					0.0			
Mic 2 (Pre-AEC)	0.0	3		-3.0	-3.0	0.0	0.0					0.0			
Mic 3 (Pre-AEC)	0.0	4		-3.0	-3.0	0.0	0.0					0.0			
Mic 4 (Pre-AEC)	0.0	5		-3.0	-3.0	0.0	0.0					0.0			
Program L	0.0	6	-3.0	0.0	0.0	-3.0	-3.0	-3.0	0.0	0.0	-3.0	-3.0		0.0	0.0
Program R	0.0	7	-3.0	0.0	0.0	-3.0	-3.0	-3.0	0.0	0.0	-3.0	-3.0		0.0	0.0
Far End 1 L	0.0	8	-3.0	0.0	0.0	-3.0	-3.0	-3.0	0.0	0.0	-3.0	-3.0		0.0	0.0
Far End 1 R	0.0	9	-3.0	0.0	0.0	-3.0	-3.0	-3.0	0.0	0.0	-3.0	-3.0		0.0	0.0
Far End 2	0.0	10	0.0	-3.0	-3.0	0.0	0.0	0.0	-3.0	-3.0	0.0	0.0		-3.0	-3.0
RC 2 Mics	OFF	11	0.0	-3.0	-3.0	0.0	0.0	0.0	-3.0	-3.0	0.0	0.0		-3.0	-3.0
RC 2 PreMics	OFF	12	0.0	-3.0	-3.0	0.0	0.0					0.0			
RC 2 NonMics	OFF	13	-3.0	0.0	0.0	-3.0	-3.0	-3.0	0.0	0.0	-3.0	-3.0		0.0	0.0
RC 2 NonMics	OFF	14	-3.0	0.0	0.0	-3.0	-3.0	-3.0	0.0	0.0	-3.0	-3.0		0.0	0.0
RC 3 Mics	OFF	15	0.0	-3.0	-3.0	0.0	0.0	0.0	-3.0	-3.0	0.0	0.0		-3.0	-3.0
RC 3 PreMics	OFF	16	0.0	-3.0	-3.0	0.0	0.0					0.0			
RC 3 NonMics	OFF	17	-3.0	0.0	0.0	-3.0	-3.0	-3.0	0.0	0.0	-3.0	-3.0		0.0	0.0
RC 3 NonMics	OFF	18	-3.0	0.0	0.0	-3.0	-3.0	-3.0	0.0	0.0	-3.0	-3.0		0.0	0.0

Example of Advanced Matrix View - Default Settings

The current status of room combining including any changes is always reflected in the Advanced Matrix View. For example, if a another room were joined with room X, the RC *n* Mics, RC *n* PreMics, and RC *n* NonMic inputs for that room would be turned ON. If the other room were not joined, then those inputs would be turned OFF.

The Advanced Matrix View tracks the current settings in the Speaker Matrix. For example, if you turn on the cross-point from Mic 1 (Pre-AEC) to Overhead 1 in the Speaker Matrix, the corresponding cross-point in the Advanced Matrix View is also turned On.

Default Settings

If any changes have been made to the Advanced Matrix View, you can click the **Default Settings** button in the Advanced Matrix View to return all settings to their factory defaults. When you return the CRR to Default Settings mode, the **Default Settings** button in the Advanced Matrix View is disabled.

NOTE: When Advanced Matrix View is *not* currently showing default settings, i.e. changes were made, an unlocked icon is displayed in the upper left corner of the CRR block.

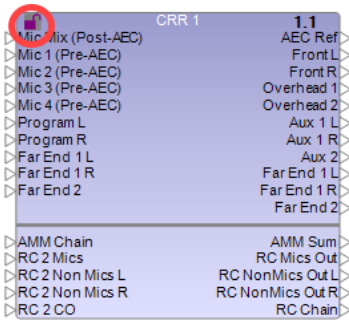

CRR block with unlocked icon - indicates not in Default Settings mode

The factory-default settings shown in Advanced Matrix View may be affected by the status of room combining and the Speaker Matrix settings.

Editing the cross-point of an RC input in the Advanced Matrix View does not affect the status of the room combining. However, a change in the status of the room combining overwrites the setting of the RC input cross-point in Advanced Matrix View.

If you change Matrix mode from Normal to Advanced, the Advanced Matrix View inherits the settings of the Speaker Matrix and these settings are used as the default settings.

If you change Matrix mode from Advanced to Normal, a warning pop-up displays indicating that the Advanced Matrix View will be reset. Any edits you made in the Advanced Matrix View will not be saved. If you click **Yes** to continue, the Advanced Matrix View is reset to the factory-default settings.

As shown in the screen example for default settings earlier in this topic, there are four combinations of input and output for default settings.

- Monaural input - monaural output
- Monaural input - stereo output
The input signal is distributed to the left output and the right output with a gain of -3 dB.
- Stereo input - monaural output
The left input signal and the right input signal are mixed with a gain of -3 dB and sent to the output.
- Stereo input - stereo output
The left input signal is sent to the left output. The right input signal is sent to the right output.

Although these default settings apply to all cross-points, you can always make adjustments to any cross-points in Advanced Matrix View.

Volume/Mute Settings

Advanced Matrix		Out:													
EX-1280C 1: CRR 1		AEC Ref	Front L	Front R	Overhear	Overhear	Aux 1	Far End	Far End	Far End	RC Mics	RC PreM	RC NonM	RC NonM	
Default Settings		0.0	0.0	0.0	0.0	0.0	0.0								
In:		1	2	3	4	5	6	7	8	9	10	11	12	13	
Mic Mix (Post-AEC)	0.0	1	0.0	-3.0	-3.0	0.0	0.0	0.0	-3.0	-3.0	0.0	0.0		-3.0	-3.0
Mic 1 (Pre-AEC)	0.0	2		-3.0	-3.0	0.0	0.0					0.0			
Mic 2 (Pre-AEC)	0.0	3		-3.0	-3.0	0.0	0.0					0.0			
Mic 3 (Pre-AEC)	0.0	4		-3.0	-3.0	0.0	0.0					0.0			
Mic 4 (Pre-AEC)	0.0	5		-3.0	-3.0	0.0	0.0					0.0			
Program L	0.0	6	-3.0	0.0	0.0	-3.0	-3.0	-3.0	0.0	0.0	-3.0	-3.0		0.0	0.0
Program R	0.0	7	-3.0	0.0	0.0	-3.0	-3.0	-3.0	0.0	0.0	-3.0	-3.0		0.0	0.0
Far End 1 L	0.0	8	-3.0	0.0	0.0	-3.0	-3.0	-3.0	0.0	0.0	-3.0	-3.0		0.0	0.0
Far End 1 R	0.0	9	-3.0	0.0	0.0	-3.0	-3.0	-3.0	0.0	0.0	-3.0	-3.0		0.0	0.0
Far End 2	0.0	10	0.0	-3.0	-3.0	0.0	0.0	0.0	-3.0	-3.0	0.0	0.0		-3.0	-3.0
RC 2 Mics	OFF	11	0.0	-3.0	-3.0	0.0	0.0	0.0	-3.0	-3.0	0.0	0.0		-3.0	-3.0
RC 2 PreMics	OFF	12	0.0	-3.0	-3.0	0.0	0.0					0.0			
RC 2 NonMics	OFF	13	-3.0	0.0	0.0	-3.0	-3.0	-3.0	0.0	0.0	-3.0	-3.0		0.0	0.0
RC 2 NonMics	OFF	14	-3.0	0.0	0.0	-3.0	-3.0	-3.0	0.0	0.0	-3.0	-3.0		0.0	0.0
RC 3 Mics	OFF	15	0.0	-3.0	-3.0	0.0	0.0	0.0	-3.0	-3.0	0.0	0.0		-3.0	-3.0
RC 3 PreMics	OFF	16	0.0	-3.0	-3.0	0.0	0.0					0.0			
RC 3 NonMics	OFF	17	-3.0	0.0	0.0	-3.0	-3.0	-3.0	0.0	0.0	-3.0	-3.0		0.0	0.0
RC 3 NonMics	OFF	18	-3.0	0.0	0.0	-3.0	-3.0	-3.0	0.0	0.0	-3.0	-3.0		0.0	0.0

Volume/Mute settings in Advanced Matrix View

The volume gain and mute settings in the Master Controls area of the **CRR control panel** are also reflected as follows in Advanced Matrix View and may not be edited:

- 1** - Mic Mix
- 2** - Non-Mic Mix
- 3** - Master Volume

An unmuted volume setting is colored blue. A muted setting is colored gray.

RC Input ON/OFF Indicators

In Advanced Matrix View only, the RC *n* Mics, RC *n* Non Mics, and RC *n* PreMics inputs each have two indicators: ON and OFF. These are set to ON when the room is combined, and OFF when it is split. They may not be edited.

Advanced Matrix		Out:												
EX-1280C 1: CRR 1		AEC Ref	Front L	Front R	Overhead	Overhead	Aux 1	Far End	Far End	Far End	RC Mics	RC PreM	RC Nonlv	RC Nonlv
Default Settings		0.0	0.0	0.0	0.0	0.0								
In:		1	2	3	4	5	6	7	8	9	10	11	12	13
Mic Mix (Post-)	0.0 1	0.0	-3.0	-3.0	0.0	0.0	0.0	-3.0	-3.0	0.0	0.0		-3.0	-3.0
Mic 1 (Pre-AEC)	0.0 2		-3.0	-3.0	0.0	0.0					0.0			
Mic 2 (Pre-AEC)	0.0 3		-3.0	-3.0	0.0	0.0					0.0			
Mic 3 (Pre-AEC)	0.0 4		-3.0	-3.0	0.0	0.0					0.0			
Mic 4 (Pre-AEC)	0.0 5		-3.0	-3.0	0.0	0.0					0.0			
Program L	0.0 6	-3.0	0.0	0.0	-3.0	-3.0	-3.0	0.0	0.0	-3.0	-3.0		0.0	0.0
Program R	0.0 7	-3.0	0.0	0.0	-3.0	-3.0	-3.0	0.0	0.0	-3.0	-3.0		0.0	0.0
Far End 1 L	0.0 8	-3.0	0.0	0.0	-3.0	-3.0	-3.0	0.0	0.0	-3.0	-3.0		0.0	0.0
Far End 1 R	0.0 9	-3.0	0.0	0.0	-3.0	-3.0	-3.0	0.0	0.0	-3.0	-3.0		0.0	0.0
Far End 2	0.0 10	0.0	-3.0	-3.0	0.0	0.0	0.0	-3.0	-3.0	0.0	0.0		-3.0	-3.0
RC 2 Mics	OFF	0.0	-3.0	-3.0	0.0	0.0	0.0	-3.0	-3.0	0.0	0.0		-3.0	-3.0
RC 2 PreMics	OFF	0.0	-3.0	-3.0	0.0	0.0					0.0			
RC 2 NonMics	OFF	0.0	0.0	0.0	-3.0	-3.0	-3.0	0.0	0.0	-3.0	-3.0		0.0	0.0
RC 2 NonMics	OFF	0.0	0.0	0.0	-3.0	-3.0	-3.0	0.0	0.0	-3.0	-3.0		0.0	0.0

Default RC input indicator settings

The indicators work as follows:

- When an RC input is OFF (red), the input signal is muted and therefore the input signal is not routed to any output, even if the applicable cross-point is On.
- When an RC input is ON (green), the input signal is not muted and therefore the input signal is routed to each output as long as the applicable cross-point is On.
- The cross-point states are not affected by any changes to room combining or splitting.
- The cross-point states are not affected by any change in RC input indicator states.

The cross-points from the RC *n* inputs can be changed to customize their routing to loudspeakers, auxiliary and far-end outputs when the room is combined.

Storing CRR Settings in Parameter Sets

To store the settings of a CRR block in a parameter set:

1. Drag and drop the CRR block into the parameter set. The Select Store Target dialog opens.

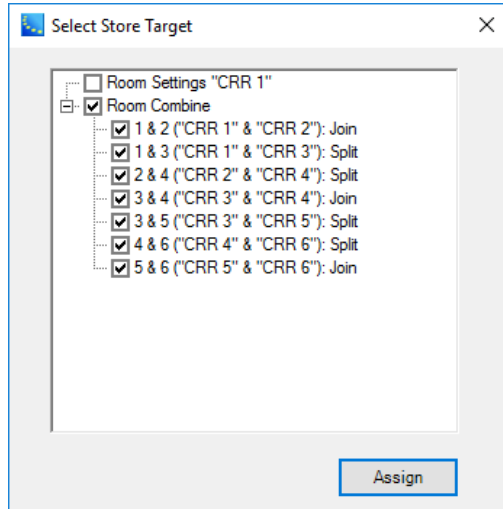

Select Store Target dialog - example

2. Select any of the following options, as needed:
 - Room Settings - any CRR settings not related to room combining. This includes volume settings, the settings of the **CRR Speaker Matrix**, and **Advanced Matrix View** settings. It also includes the current state of ON/OFF indicators for RC n Mics, RC n Non Mics, and RC n PreMics in the Advanced Matrix View. If selected, these settings are stored in the parameter set.
 - Room Combine - only CRR settings related to room combining. You can select each room combination to store in the parameter set.
3. Click **Assign** to commit the selected settings to the parameter set.

For more information on using parameter sets, see [Parameter Sets](#).

Linking CRR Blocks to Automatic Mic Mixer Blocks

CRR blocks can be used in combination with either **Automatic Microphone Mixer - Gain Sharing** or **Automatic Microphone Mixer - Gated (EX-1280C only)** blocks. You can link AMM blocks to CRR blocks to create a larger mix upstream of the CRR. Additionally, it is possible to link AMM blocks on different sound processors. In this case, you need to connect the blocks via Dante audio routes (see [Managing Dante Audio Routes](#)).

When the CRRs are combined in an RCGroup, the AMM blocks connected to them may need to link to each other. In this case, set the link mode of the AMM appropriately:

- AMM - Gain Sharing - Set the link mode to **Slave**.
- AMM - Gated - Set the link mode to **CRC**.

You also need to connect the following input and output ports on the CRR block:

- AMM Chain - input port for inputting the sum of the mic inputs of the AMM. Connect this input to the Chain output of the AMM block. The signal from the CRR's AMM Chain input is sent to the CRR's AMM Sum output and the RC Chain output.
- AMM Sum - output port for outputting the sum of all mic inputs of the AMMs. Connect this output to the Sum input of the AMM block. The following input signals are sent to this output:
 - AMM Chain
 - RC n Chain (only when rooms are combined)

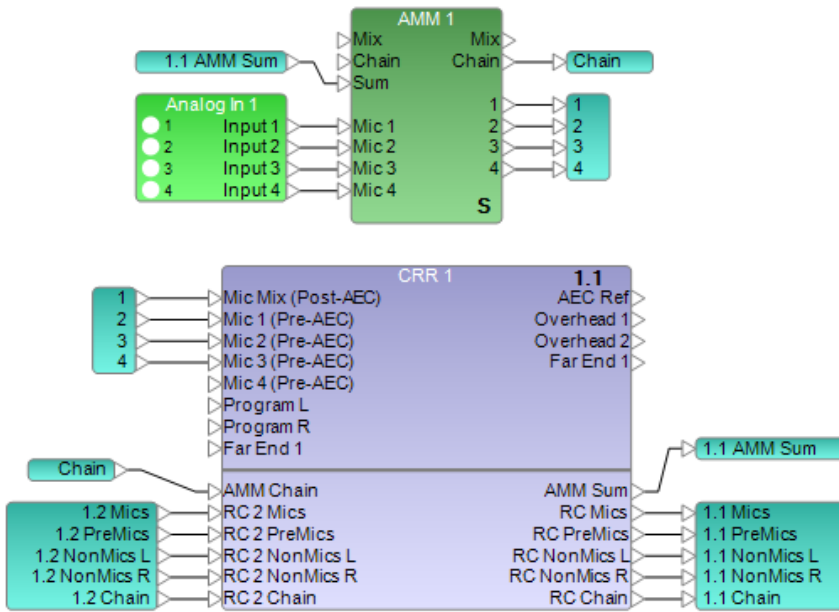

Example of CRR linked to AMM - Gain Sharing block

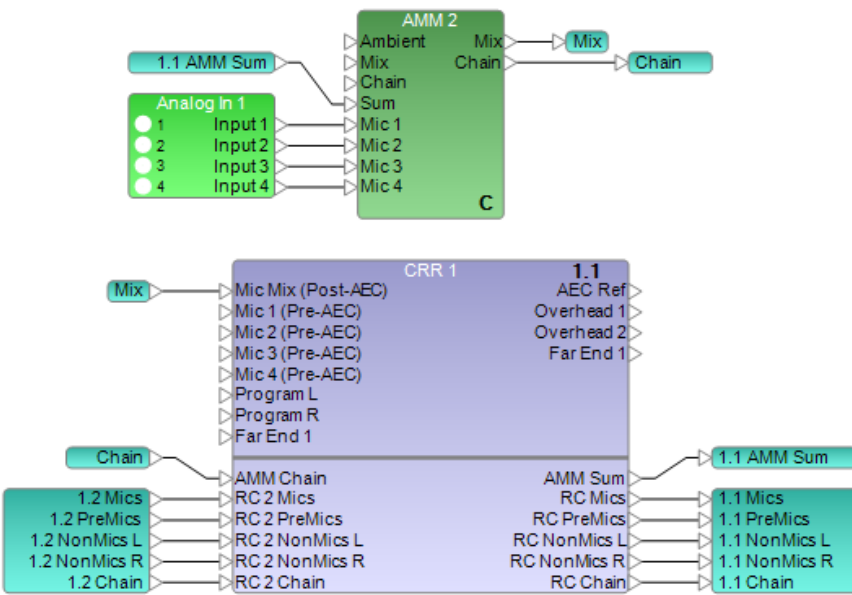

Example of CRR linked to AMM - Gated block

In the CRR block, the signal which is inputted to its AMM Chain port is sent to the RC Chain output port. The signal from the RC Chain output port is then sent to the RC *n* Chain port of the other CRR blocks that are combined with this CRR.

If the CRR blocks are combined, the input signals from RC *n* Chain and from AMM Chain are mixed and then sent to the AMM Sum output port.

If the CRR blocks are not combined, the input signal from RC *n* Chain and from AMM Chain are *not* mixed and only the input signal from AMM Chain is sent to the AMM Sum output port.

As a result, the output signal from the AMM Sum output port is equivalent to the sum of all of the Chain outputs of the AMM blocks that are connected to the combined CRR block.

CRR blocks also mix mic signals according to the condition of the combination of CRR blocks. Therefore, you do not have to cascade the Mix inputs and Mix outputs of the AMM blocks.

Below is an overview of how to design a 3-zone room combining system using the CRR.

When using the CRR and the RCGroups, all the routing will be done automatically.

Change the link status for each AMM to **CRR** and wire for each AMM Chain and Sum to the corresponding CRR.

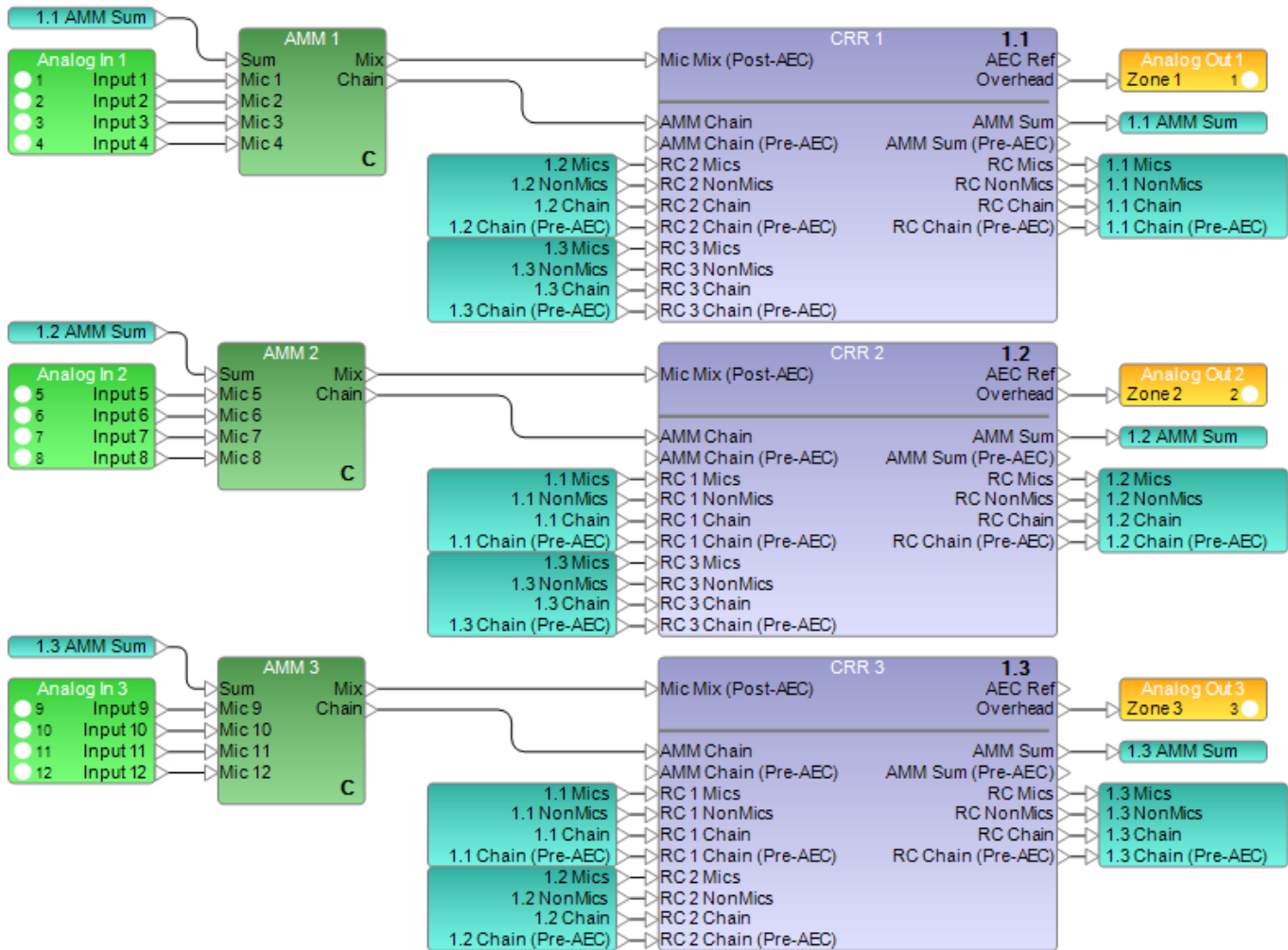

See [Linking AMM Blocks to Extend Channels](#) for more information and examples.

Filters/Crossovers

A crossover divides an input signal into two or more frequency ranges, and sends each range (or band-pass) to a separate output. The SP Tool Kit offers 2-way, 3-way, and 4-way crossovers. The controls and functions are identical other than the number of outputs.

2-way crossover

A 2-way crossover divides an input signal into two frequency ranges, high and low, and sends these signals to two outputs marked H (high) and L (low). Double-click on the 2-way crossover block within the signal processing view to open its control panel.

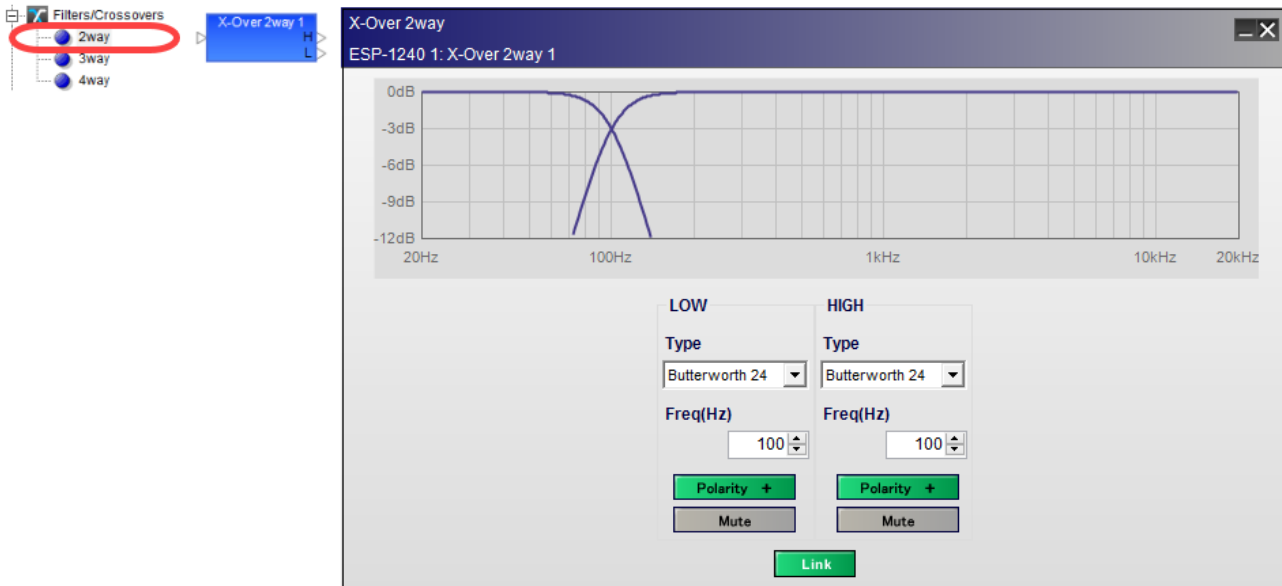

2-way crossover, processing block and control panel

The **2-way crossover control panel** provides the following options:

Crossover Graph – displays a graphical representation of adjustable crossover filter settings in both frequency and level. The line to the left represents the low frequency output level and the line to the right represents the high frequency output level.

LOW – adjusts the low frequency filter parameters.

Type – selects the filter type. The filter type and slope may be set independently for each filter in the crossover block.

Options include:

Type	Slope	Type	Slope	Type	Slope
Butterworth 6	6 dB/oct				
Butterworth 12	12 dB/oct	Bessel 12	12 dB/oct		
Butterworth 18	18 dB/oct	Bessel 18	18 dB/oct	Linkwitz-Riley 12	12 dB/oct
Butterworth 24	24 dB/oct	Bessel 24	24 dB/oct	Linkwitz-Riley 24	24 dB/oct
Butterworth 36	36 dB/oct	Bessel 36	36 dB/oct	Linkwitz-Riley 36	36 dB/oct
Butterworth 48	48 dB/oct	Bessel 48	48 dB/oct	Linkwitz-Riley 48	48 dB/oct

Freq(Hz) – specifies the specific filter frequency via direct entry or by using the spinner controls. Adjustments may be made in 1Hz increments. When the Link option is engaged, the frequency of the adjacent filter is also changed.

Polarity – inverts the polarity to the filter. When *Polarity* is normal, the control panel button is Green and a plus (+) sign is present. When *Polarity* is reversed, the control panel button is Red and a minus (-) sign is present.

Mute – mutes the audio output for the frequency band. When Mute is enabled, the control panel button is Red.

HIGH – adjusts the high frequency filter parameters.

Type – selects the filter type and slope.

Options are identical to low frequency filter parameters.

Freq(Hz) – specifies the specific filter frequency via direct entry or by using the spinner controls. Adjustments may be made in 1Hz increments. When the Link option is engaged the frequency of the adjacent filter is also changed.

Polarity – inverts the polarity to the filter. When *Polarity* is normal, the control panel button is Green and a plus (+) sign is present. When *Polarity* is reversed, the control panel button is Red and a minus (-) sign is present.

Mute – mutes the audio output for the frequency band. When Mute is enabled, the control panel button is Red.

Link -matches the adjacent filters to the same frequency. This option is only available if the adjacent filter types are both Butterworth or both Linkwitz-Riley filter types. If the Link button is off, the filter frequencies can be set independently.

3-way crossover

A **3-way crossover** divides an input signal into three frequency ranges, high, low mid, and low, and sends these signals to three outputs marked H (high), M (mid), and L (low). Double-click on the 3-way crossover block within the signal processing view to open its control panel.

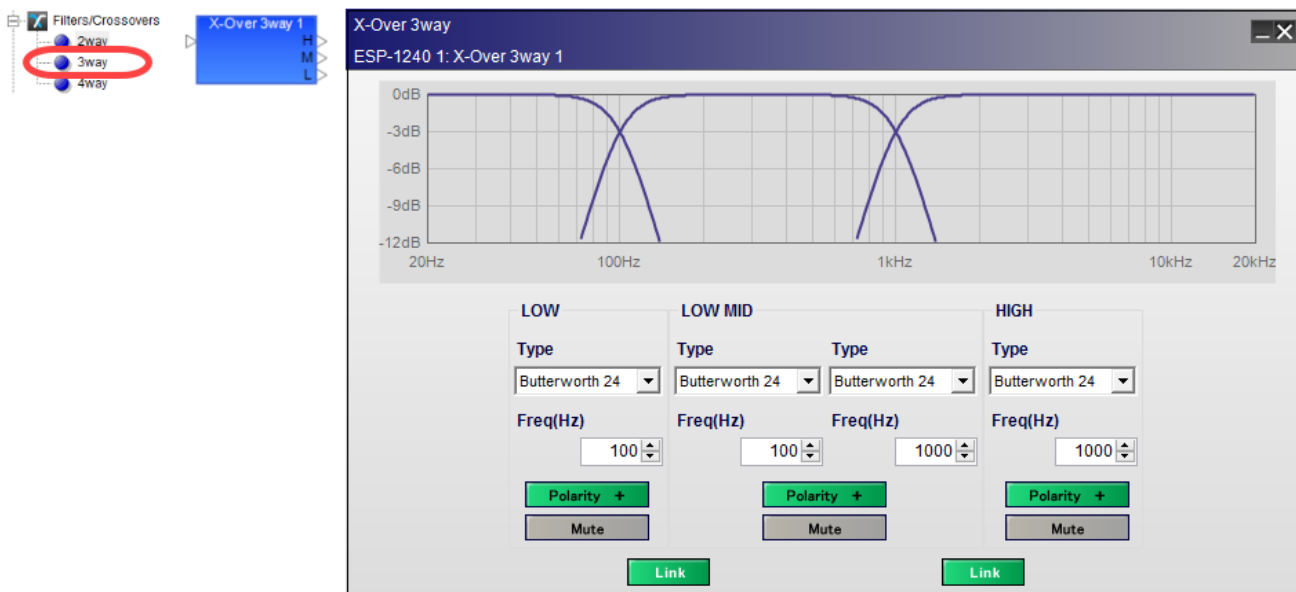

3-way crossover, processing block and control panel

The **3-way crossover control panel** provides all the options of the 2-way crossover plus:

LOW MID – adjusts the mid frequency filter parameters.

Type – selects the filter type and slope. The upper and lower filters for the bandpass are individually set. Options include:

Type	Slope	Type	Slope	Type	Slope
Butterworth 6	6 dB/oct				
Butterworth 12	12 dB/oct	Bessel 12	12 dB/oct		
Butterworth 18	18 dB/oct	Bessel 18	18 dB/oct	Linkwitz-Riley 12	12 dB/oct
Butterworth 24	24 dB/oct	Bessel 24	24 dB/oct	Linkwitz-Riley 24	24 dB/oct
Butterworth 36	36 dB/oct	Bessel 36	36 dB/oct	Linkwitz-Riley 36	36 dB/oct
Butterworth 48	48 dB/oct	Bessel 48	48 dB/oct	Linkwitz-Riley 48	48 dB/oct

Freq(Hz) - specifies the specific filter frequency via direct entry or by using the spinner controls. Adjustments may be made in 1Hz increments. When the Link option is engaged, the frequency of the adjacent filter is also changed.

Polarity - inverts the polarity to the filter. When *Polarity* is normal, the control panel button is Green and a plus (+) sign is present. When *Polarity* is reversed, the control panel button is Red and a minus (-) sign is present.

Mute - mutes the audio output for the frequency band. When Mute is enabled, the control panel button is Red.

Link - matches the adjacent filters to the same frequency. This option is only available if the adjacent filter types are both Butterworth or both Linkwitz-Riley filter types. If the Link button is off, the filter frequencies can be set independently.

4-way crossover

A **4-way crossover** divides an input signal into four frequency ranges, high, high mid, low mid, and low, and sends these signals to four outputs marked H (high), HM (high mid), LM (low mid), and L (low).

4-way crossover, processing block and control panel

The **4-way crossover control panel** provides all the options of the 3-way crossover plus:

HIGH MID – adjusts the mid frequency filter parameters.

Type – selects the filter type and slope. The upper and lower filters for the bandpass are individually set. Options include:

Type	Slope	Type	Slope	Type	Slope
Butterworth 6	6 dB/oct				
Butterworth 12	12 dB/oct	Bessel 12	12 dB/oct		
Butterworth 18	18 dB/oct	Bessel 18	18 dB/oct	Linkwitz-Riley 12	12 dB/oct
Butterworth 24	24 dB/oct	Bessel 24	24 dB/oct	Linkwitz-Riley 24	24 dB/oct
Butterworth 36	36 dB/oct	Bessel 36	36 dB/oct	Linkwitz-Riley 36	36 dB/oct
Butterworth 48	48 dB/oct	Bessel 48	48 dB/oct	Linkwitz-Riley 48	48 dB/oct

Freq(Hz) – specifies the specific filter frequency via direct entry or by using the spinner controls. Adjustments may be made in 1Hz increments. When the Link option is engaged, the frequency of the adjacent filter is also changed.

Polarity – inverts the polarity to the filter. When *Polarity* is normal, the control panel button is Green and a plus (+) sign is present. When *Polarity* is reversed, the control panel button is Red and a minus (-) sign is present.

Mute – mutes the audio output for the frequency band. When Mute is enabled, the control panel button is Red.

Link - matches the adjacent filters to the same frequency. This option is only available if the adjacent filter types are both Butterworth or both Linkwitz-Riley filter types. If the Link button is off, the filter frequencies can be set independently.

Delay

Delay blocks insert delay (time) into the audio signal chain. The SP Tool Kit offers delays blocks with one, two, four, and eight outputs. Delay values for each output are set individually.

Double-click on the Delay block in Signal Processing View to open its control panel.

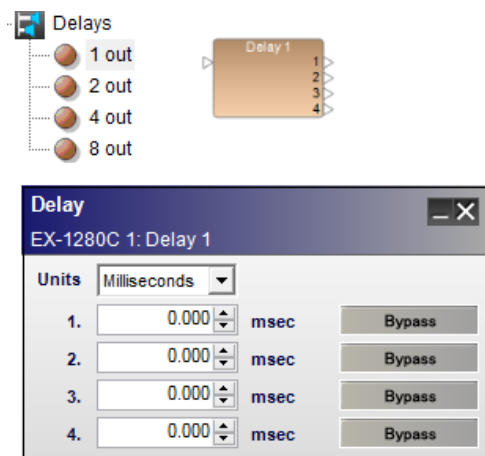

Four-channel Delay processing block and control panel

The **Delay control panel** provides the following options:

Units – defines the unit of measure for signal delay. **NOTE: Distance units are based on the speed of sound, which is affected by temperature. The reference temperature setting is found in the Tools> Set Temperature window.** Supported units are:

Milliseconds (0-1000 ms)

Sample (0-48,000 samples)

Meter (0-343.7 m)

Millimeter (0-343,700 mm)

Feet (0-1127.625 ft)

Inch (0-13,531.496 in)

Output Delay – adjusts the signal delay delivered to the next signal processing block. The range of adjustment varies according to the units chosen.

Bypass – removes the signal delay from the associated output. When bypass is active, the button turns green. When inactive, the button is gray.

Ducker

The Ducker reduces the level of an input signal when an alternate signal is present on the side-chain input. Both a monoaural Ducker with one input and a side-chain input, and a stereo Ducker with stereo inputs and a side-chain input are supported.

Control panels for mono and stereo versions are identical.

Double-click on the Ducker block in Signal Processing View to open its control panel.

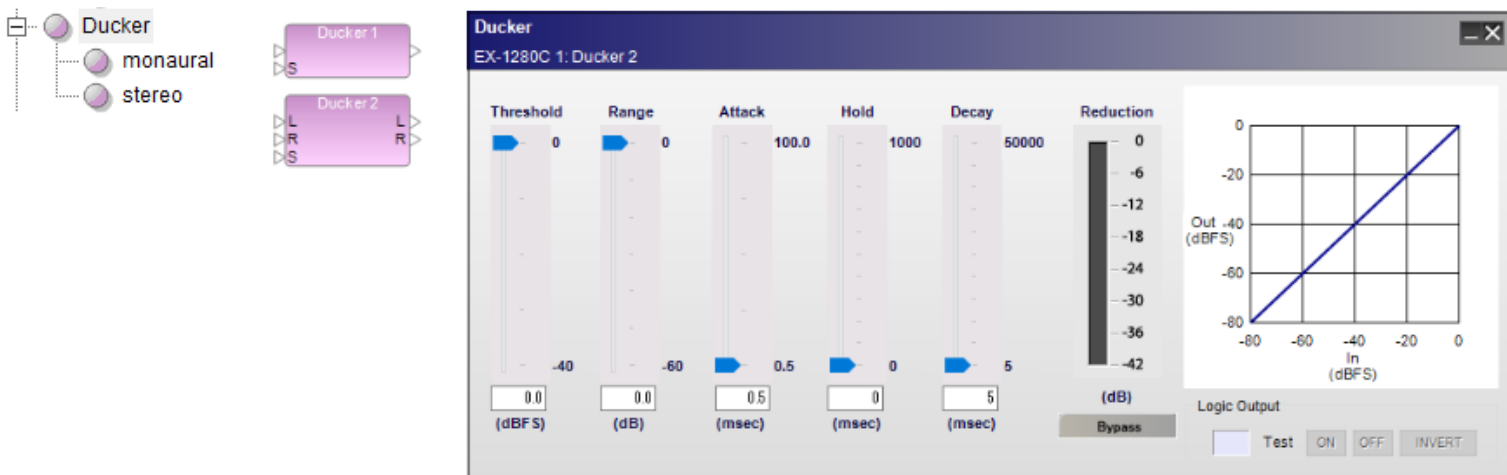

Ducker processing blocks and control panel

The Ducker control panel provides the following options:

Threshold slider – determines the level of the side-chain signal at which the processing block will begin adjusting the audio input signal. When the side-chain signal drops below the threshold value, the audio signal is unaffected.

Threshold gain value – is entered directly into the box. The range of adjustment is -40 to 0 dBFS (default) and tracks the threshold slider setting.

Range slider – dictates the amount of signal attenuation when the ducker is active.

Range value – is entered directly into the box. The range of adjustment is -60 to 0 dB (default) and tracks the range slider setting.

Attack slider – establishes the rate in milliseconds at which input signals are processed once they exceed threshold.

Attack value – is entered directly into the box. The range of adjustment is from 0.5 milliseconds (default) to 100 milliseconds.

Hold slider – determines the length in time (milliseconds) that the audio signal remains attenuated once the side-chain signal level drops below the threshold setting.

Hold value – is entered directly into the box. The range of adjustment is from 0 milliseconds (default) to 1000 milliseconds.

Decay slide– establishes the rate in milliseconds at which the audio signal returns to its normal state once the hold time expires.

Decay value – is entered directly into the box. The range of adjustment is from 5 milliseconds (default) to 50000 milliseconds.

Reduction meter – displays a vertical bar level indicator to illustrate the amount of signal reduction that has been applied.

Bypass – bypasses the detection circuit. The audio signal level is unaffected.

Ducker graph - illustrates the input level versus the output level of the signal in a graphical manner.

Logic Output options - for information on logic support for Ducker blocks, see [Logic and Testing Support for SP Blocks](#).

NOTE: The side-chain input signal is only used as a trigger signal, it is not passed to the ducker output. To hear this signal, you must mix it back in to the signal chain along with the Ducker output.

Gain

Gain blocks provide a convenient method to add individual gain control points within a system design. These blocks use the fewest CPU resources of any other signal processing element and are helpful in many applications.

Setting the Number of Ports

To set the number of input and output ports for a Gain block:

1. Drag the Gain block into Signal Processing View.
2. In the Gain dialog, you can select a standard 1x1, 2x2, 4x4, or 8x8 port block. Alternatively, you can select or type in the number of ports (8 max) using the Input ports selector control.

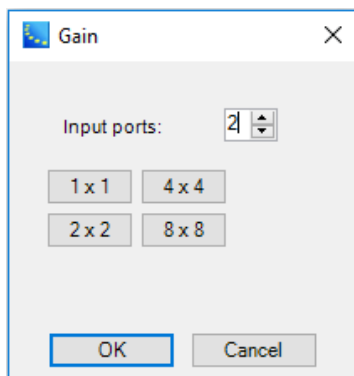

3. Click **OK** to add the block to the Signal Processing View.

The number of channels may be modified by right clicking on the block and selecting **Change Channel Count**. The maximum number of channels is 8.

Gain Block and Control Panel

Double-click on the Gain block in Signal Processing View to open its control panel.

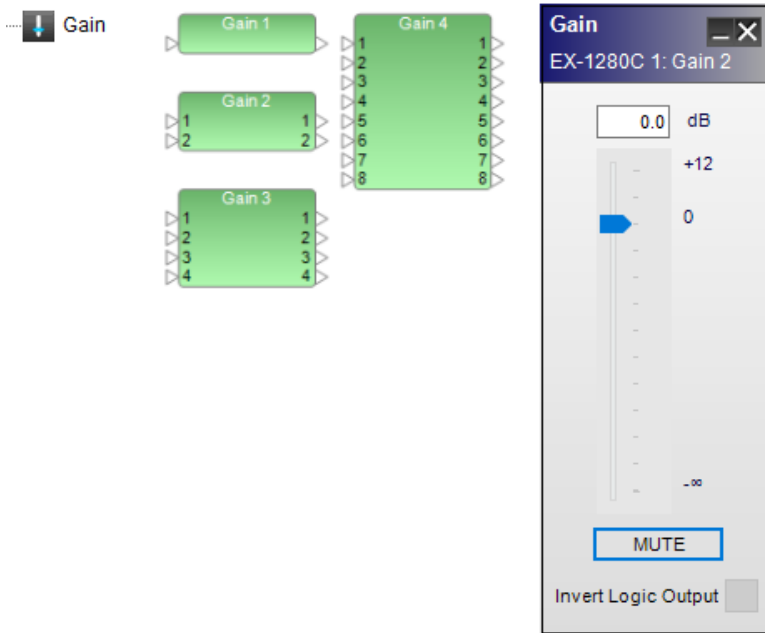

Gain processing blocks and control panel

The **Gain control panel** provides the following options:

Gain Value – permits direct entry of desired signal level in dB. Range of adjustment matches and tracks the input gain slider.

Gain Slider – adjusts the input signal level delivered to the next signal processing block. The range of adjustment is from $-\infty$ to +12dB.

Mute – silences the signal and disables audio from passing to the next signal processing block in the design. When Mute is enabled, the control panel button is Red.

Invert Logic Output – when this option is selected, a **High** logic input results in a **Low** output and the main audio is unmuted. A **Low** logic input results in a **High** output and the main audio is muted. For more information on logic support for Gain blocks, see [Logic and Testing Support for SP Blocks](#).

Gate

Gate attenuates input signals below the designated threshold. Both a monaural Gate with one input and a side-chain input, and a stereo Gate with stereo inputs and a side-chain input are supported.

Control panels differ only in the choice of input signal used as the trigger signal.

Double-click on the Gate block in Signal Processing View to open its control panel.

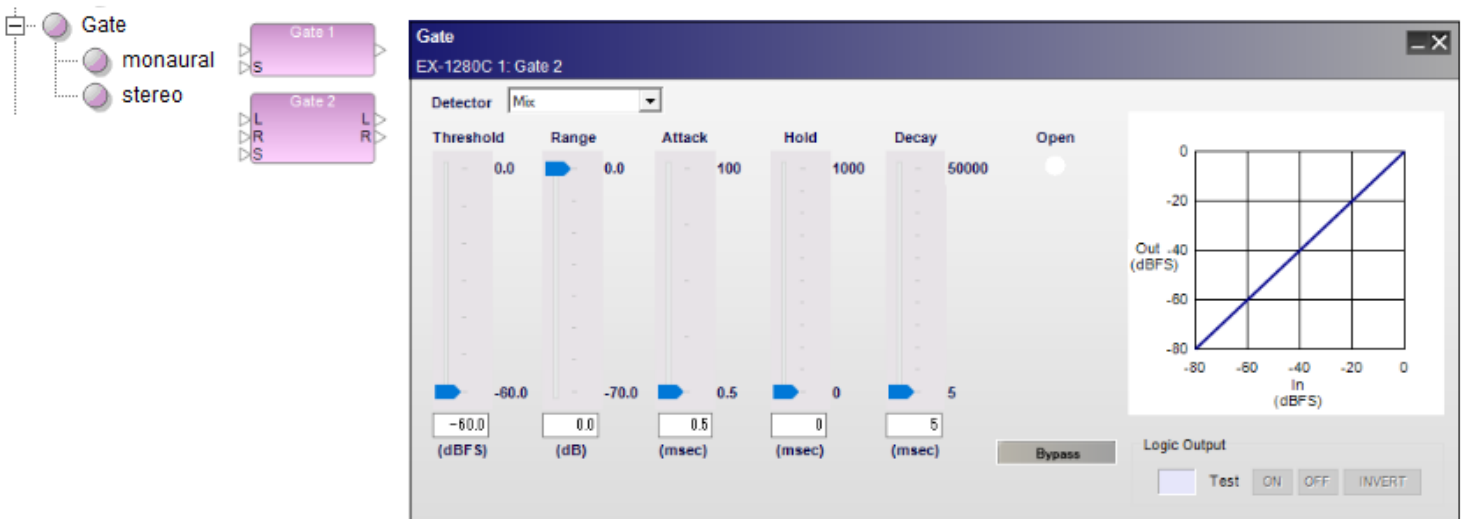

Gate processing blocks and control panel for stereo gate, with side-chain enabled

The Gate control panel provides the following options:

Detector – determines which incoming signal is sent to the detector circuit to activate the signal processing.

Input - (mono only) indicates the input signal is the trigger for processing.

Left - indicates the left signal is the trigger for processing.

Right - indicates the right signal is the trigger for processing.

Mix - indicates a left/right signal mix is the trigger for processing.

Side Chain - indicates an alternate signal connected to the side-chain input is the trigger for processing.

Threshold slider – determines when the processing block will begin adjusting the input signal. When the input or side-chain signal drops below the threshold value, the audio signal will not pass through the processing block.

Threshold gain value – is entered directly into the box. The range of adjustment is -60 to 0 dBFS (default) and tracks the threshold slider setting.

Range slider – dictates the amount of reduction in volume when the Gate is active.

Range value – is entered directly into the box. The range of adjustment is -70 to 0 dB (default) and tracks the range slider setting.

Attack slider – establishes the rate in milliseconds at which input signals are processed once they exceed threshold.

Attack value – is entered directly into the box. The range of adjustment is from 0.5 milliseconds (default) to 100 milliseconds.

Hold slider – determines the length in time (milliseconds) that the audio signal remains unattenuated once the Detector signal level drops below the threshold setting.

Hold value – is entered directly into the box. The range of adjustment is from 0 milliseconds (default) to 1000 milliseconds.

Decay slider – establishes the rate in milliseconds at which the audio signal returns to a gated state once the Detector signal level drops below the threshold setting.

Decay value – is entered directly into the box. The range of adjustment is from 5 milliseconds (default) to 50000 milliseconds.

Open – is an indicator to illustrate signal is passing through the gate to its output. When the gate is closed and no signal is passing, the indicator is White. When the gate is open and signal is passing, the indicator is Blue.

Bypass – forces the channel to remain open at all times by circumventing the detection circuitry.

Gate graph - illustrates the input level versus the output level of the signal in a graphical manner. The line represents the effect of the gate processing values.

Logic Output options - for information on logic support for Gate blocks, see [Logic and Testing Support for SP Blocks](#).

1/3 Oct Graphic EQ

The 1/3 Oct Graphic EQ boosts or cuts the output level at 31 different frequencies and at 1/3 octave intervals from 20 Hz to 20 kHz. Double-click on the 1/3 Oct Graphic EQ block in Signal Processing View to open its control panel.

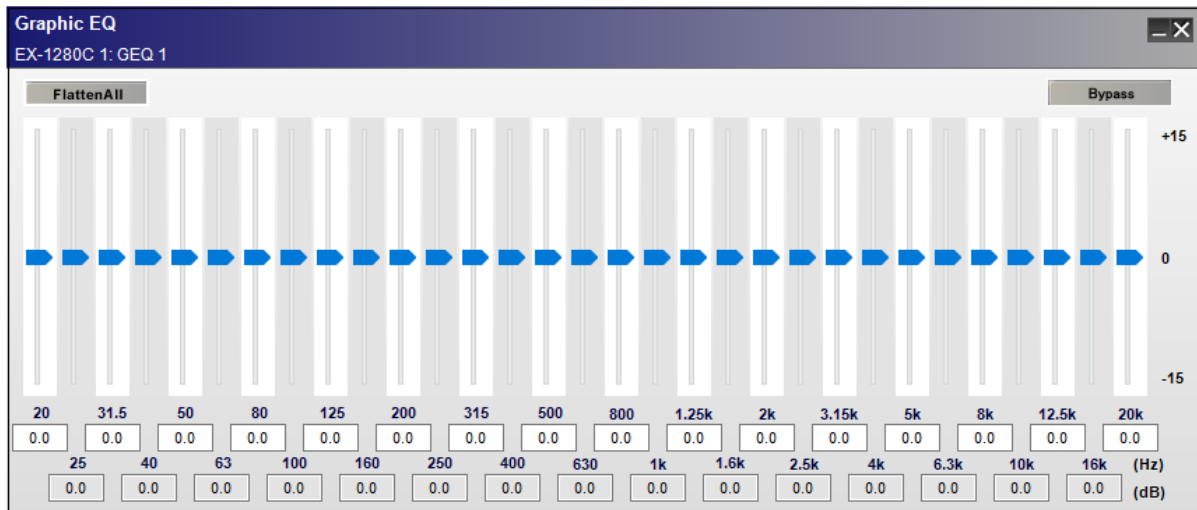

1/3 Oct Graphic EQ, processing block and control panel

The **1/3 Oct Graphic EQ control panel** provides the following options:

Flatten All – resets all gain sliders to zero.

Bypass – disables all equalizer settings from affecting the signal.

Gain Sliders – are adjustable for each frequency to boost or cut the level from -15 dB to 15 dB. Type in a boost or cut value in the input box below each slider to set the gain.

Matrix Mixer

The Matrix Mixer is used to combine (mix) and route input and output signals. Unlike the standard mixer, the input signal levels may be adjusted at each individual routing point or crosspoint.

Setting the Number of Ports

To set the number of input and output ports for a Matrix Mixer block:

1. Drag the Matrix Mixer block into Signal Processing View.
2. In the Matrix Mixer dialog, you can select from list of pre-defined port configurations, such as 2x2, 2x4, 8x8, 8x16 and many others. Alternatively, you can select or type in the number of input and

output ports (up to 32 each, max) using the Input and Output ports selector controls.

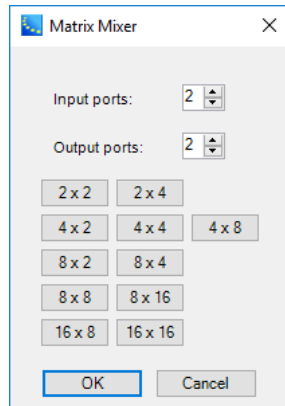

3. Click **OK** to add the block to the Signal Processing View.

You can modify the number of input and output channels by right clicking on the block and selecting **Change Channel Count**. The maximum number of input or output channels is 32.

Matrix Mixer Block and Control Panel

Double-click on the Matrix Mixer block in Signal Processing View to open its control panel.

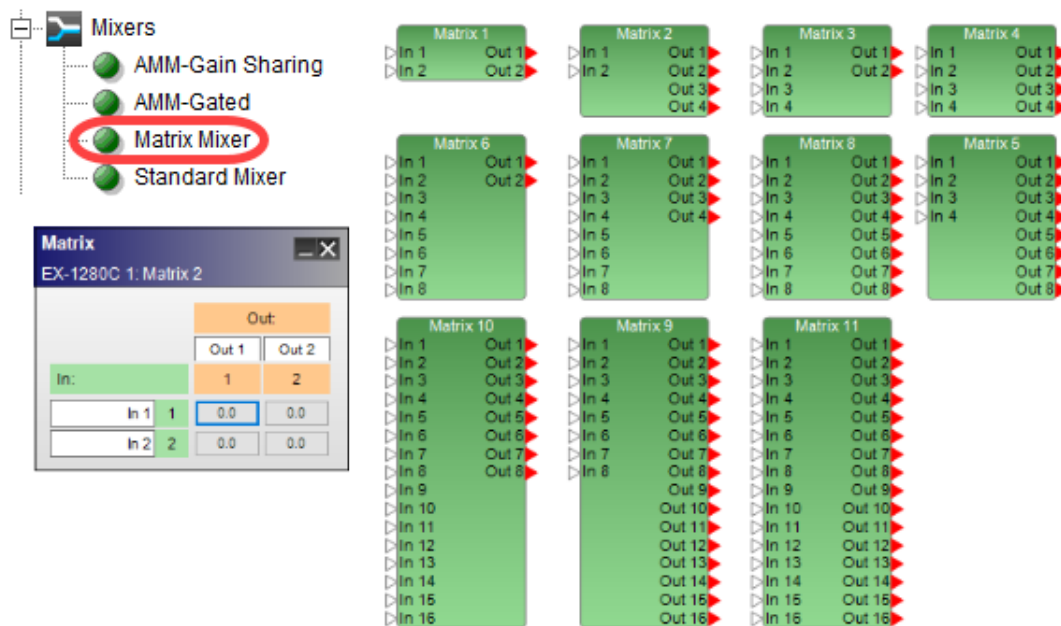

Matrix Mixer processing blocks and 2x2 control panel

The **Matrix Mixer control panel** provides the following options:

Input and Output Labels– allow direct entry of user-defined labels for inputs or outputs.

Assign – creates a routing path between an input and an output. Select the assign box at the intersection of the two channels to permit audio to pass from input to output. When an assignment is made, the assign box turns blue.

Assign Level – provides a signal gain adjustment at the assignment cross-point. Right click on the assign box to access a gain slider. The range of adjustment is from $-\infty$ to 0.0dB.

Meters

Meters provide vertical bar level indicators for monitoring signals. Meter processing blocks are available in four, eight, and 16-channel versions. Double-click on a Meter block in Signal Processing View to open its control panel.

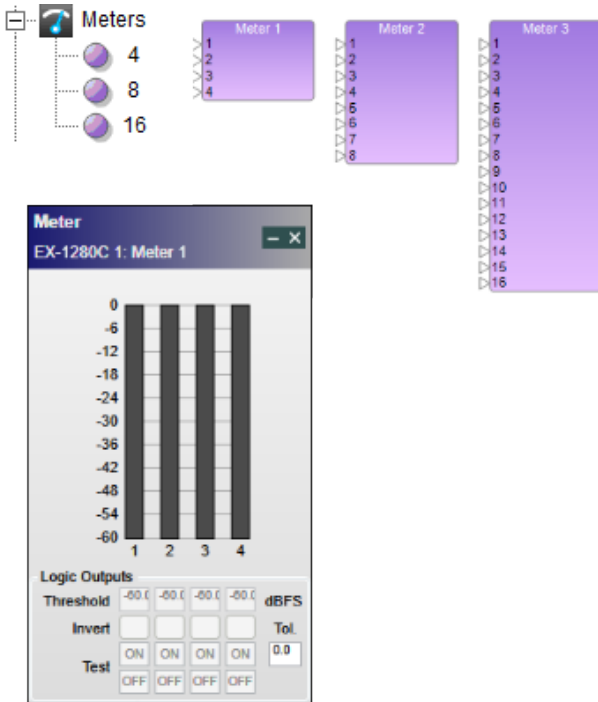

Meters processing blocks and control panel

The Meters control panel provides the following options:

Bar Level Indicators - provide a four-color graph to represent signal level. Values range from -60 to 0 dBFS (Full Scale). Color ranges are as follows:

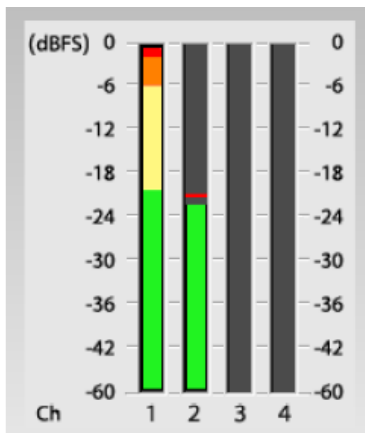

Green	-60 to -20 dBFS
Yellow	-20 to -6 dBFS
Orange	-6 to -2 dBFS
Red	-2 to 0 dBFS

Logic Output options - these options display only when **Show Logic I/O** is selected in the context menu for the block. For information on logic support for Meters blocks, see [Logic and Testing Support for SP Blocks](#).

Variable Parametric EQs

Variable parametric equalizer (VPEQ) signal processing blocks provide extensive control of individual equalization filters (or bands) to modify the frequency response of a signal. The user can control the type, center frequency, bandwidth, and gain of each filter. VPEQ SP blocks range between 3-16 individual filters (or bands) and are available in monoaural or stereo versions.

Selecting the Number of Bands

To select the number of bands for a VPEQ block:

1. Drag the mono or stereo VPEQ block into Signal Processing View.
2. In the PEQ dialog, you can select a standard 3, 5, 7, or 9 band block. Alternatively, you can select or type in the number of bands (16 max) using the Bands selector control.



3. Click **OK** to add the block to the Signal Processing View.



Mono and Stereo Variable Parametric EQ blocks

Variable PEQ Control Panel

To access the Variable PEQ control panel, double click the VPEQ block in Signal Processing View.

The control panels for each block differ only in the number of bands available for boost or cut. The mono and stereo blocks have the same control panel features.

Type	Freq (Hz)	Q	Gain (dB)	Bypass
1 PEQ	1000	1.000	0.0	Bypass
2 PEQ	1000	1.000	0.0	Bypass
3 PEQ	1000	1.000	0.0	Bypass
4 PEQ	1000	1.000	0.0	Bypass
5 PEQ	1000	1.000	0.0	Bypass
6 PEQ	1000	1.000	0.0	Bypass
7 PEQ	1000	1.000	0.0	Bypass
8 PEQ	1000	1.000	0.0	Bypass
9 PEQ	1000	1.000	0.0	Bypass

Example: Mono 9-Band Variable Parametric EQ control panel

The **Variable Parametric EQ control panel** provides the following options:

Snapshot – provides a method to define and store multiple versions of the SP block settings for quick recall within a particular SP block. To recall a user-defined snapshot, select one of the stored snapshots from the drop-down list. Snapshot definitions are saved within the .CSP project file.

Name - for convenience, each snapshot can be given a familiar name when stored. When no name is entered, a default name is automatically generated. **NOTE: The snapshot named "Default Setting" will always return all filters to the default (flat) state and cannot be updated.**

Store – commits the current settings to the Snapshot list after entering a custom name. **NOTE: Stored snapshots are only available within the current SP block.**

Delete – removes a currently recalled snapshot definition from the Snapshot list. Deleting a snapshot does not alter the current block settings.

NOTE: VPEQ settings may be exported as a separate .PEQ file using the **Save Settings button in the control panel.**

VPEQ Graph – displays a graphical representation of adjustable parametric filter settings in both frequency and level. The dark horizontal line on the graph represents the EQ curve and the blue boxes represent the center frequency of each filter band.

By default, all center frequencies are positioned at 1000 Hz, so the blue boxes are all at the same point. You may adjust the center frequency and gain for each filter band via direct entry or by dragging the blue box with your mouse in the PEQ Graph.

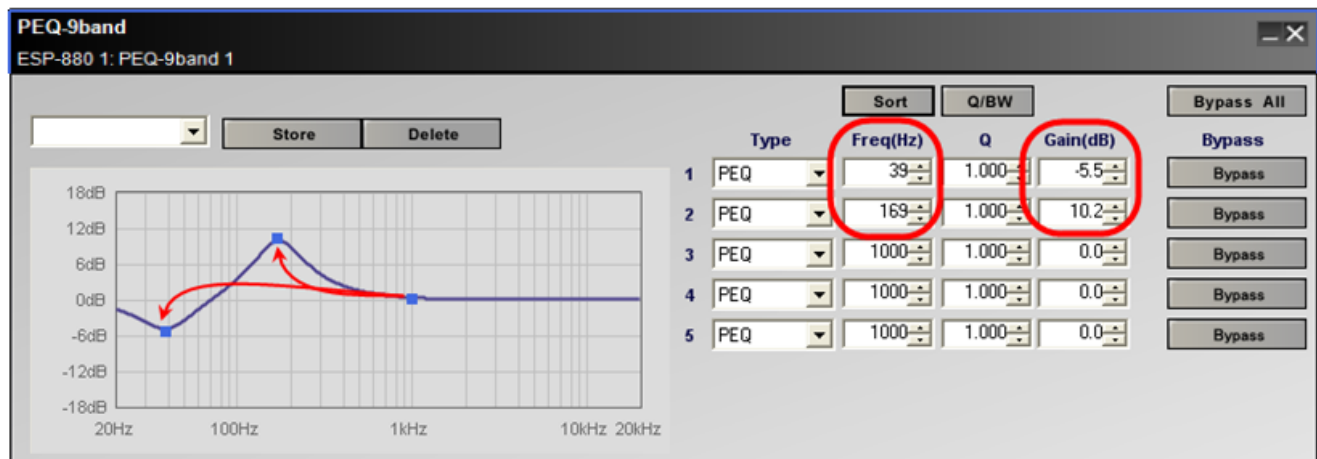

Load / Save Settings – all VPEQ settings may be saved and exported as a separate .PEQ file on the computer. A .PEQ file can be loaded into VPEQ blocks in other .CSP project files.

Sort – reorders the list of filters by frequency from low to high.

Q/BW – provides a toggle switch between the two unit systems representing filter bandwidth. Q is the ratio of the center frequency divided by the bandwidth. The BW option is more commonly used and indicates octave bandwidth of the filter. Modification of this field is only possible for Parametric (PEQ) and Notch filter types.

Type – is a drop-down list of unique filter types available for use on each EQ filter. Filter type descriptions and illustrations are shown below:

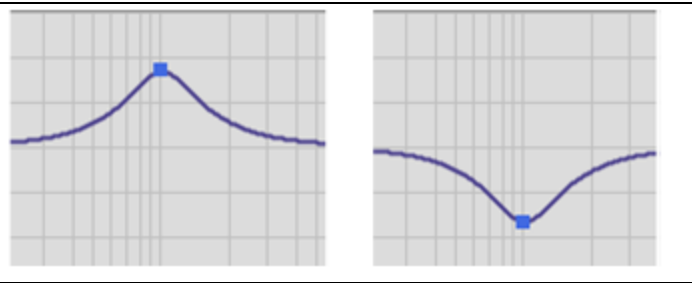
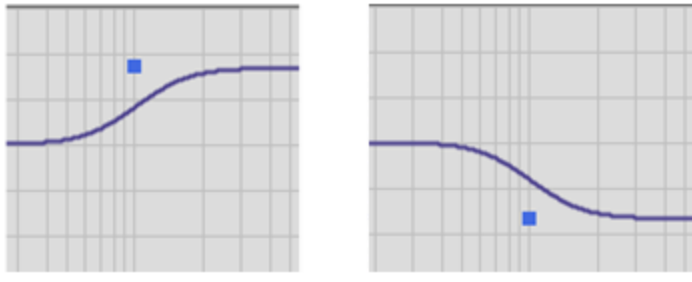
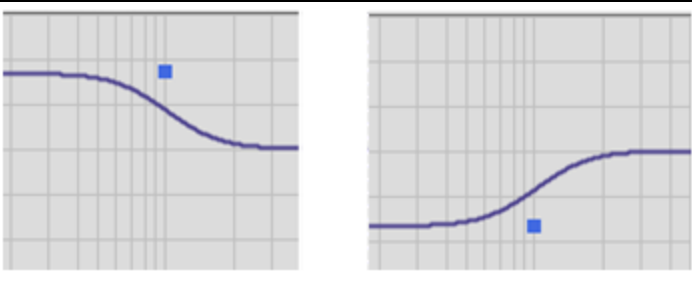
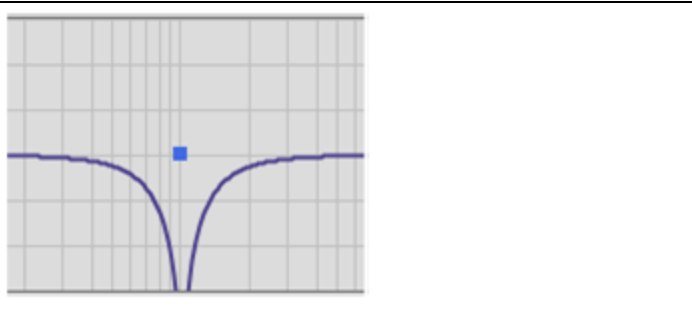
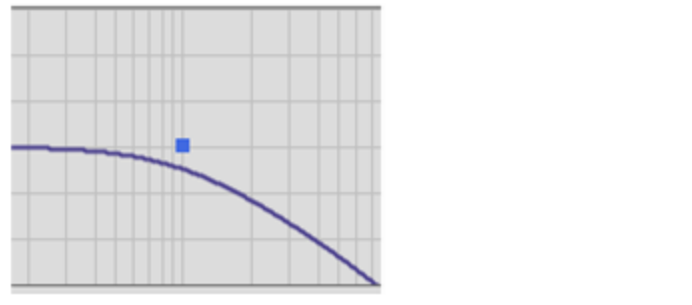
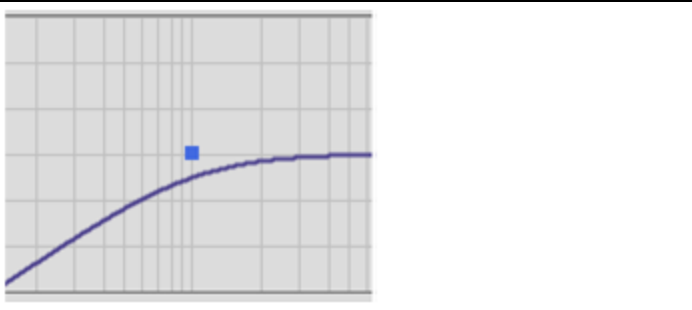
<p>PEQ</p> <p>Boosts and cuts the signal in the vicinity of the specified frequency.</p>	
<p>High Shelf</p> <p>Boosts and cuts the signal above the specified frequency.</p>	
<p>Low Shelf</p> <p>Boosts and cuts the signal below the specified frequency.</p>	
<p>Notch</p> <p>Attenuates the signal at the specified frequency.</p>	
<p>Low Pass</p> <p>Attenuates the signal above the specified frequency.</p>	
<p>High Pass</p> <p>Attenuates the signal below the specified frequency.</p>	

Parametric filter types

Frequency – specifies the center frequency of the filter band in Hertz (Hz). The range of permitted values entered directly into the text box or by using the scroll buttons is 20 Hz to 20 kHz.

Q or BW – value representing filter width. This column displays either **Q** or **BW** depending on the state of the **Q/BW** toggle button directly above this column. When using filter types other than PEQ or Notch, this field is not available.

Gain – is the amount of cut or boost applied to the filter in dB, from -20 to 20. When using Low Pass and High Pass filters, this field is used to adjust the slope of the attenuation curve (-6 dB/Oct, or -12 dB/Oct).

Bypass All – engages all individual bypass buttons simultaneously. When active, the button turns green. When inactive, the button is gray.

Bypass – use the Bypass buttons to remove an individual filter from the signal chain. When active, the button turns green. When inactive, the button is gray.

Add/Delete Band– adds or deletes a band from the list.

Peak RMS Limiter

The Peak vs. RMS Limiter processing can be set to protect speakers from thermal damage when excessive power is applied for long periods of time (RMS limiting), and mechanical damage due to over-exursion (Peak Limiting).

NOTE: To properly protect loudspeakers, Peak and RMS levels must be calibrated with the actual amplifier output voltage according to the loudspeaker specifications.

Both a monaural version with one input and a side-chain input, and a stereo version with stereo inputs and a side-chain input are supported.

Control panels for mono and stereo versions differ only in the choice of input trigger signals.

Double-click on the Peak RMS Limiter block in Signal Processing View to open its control panel.

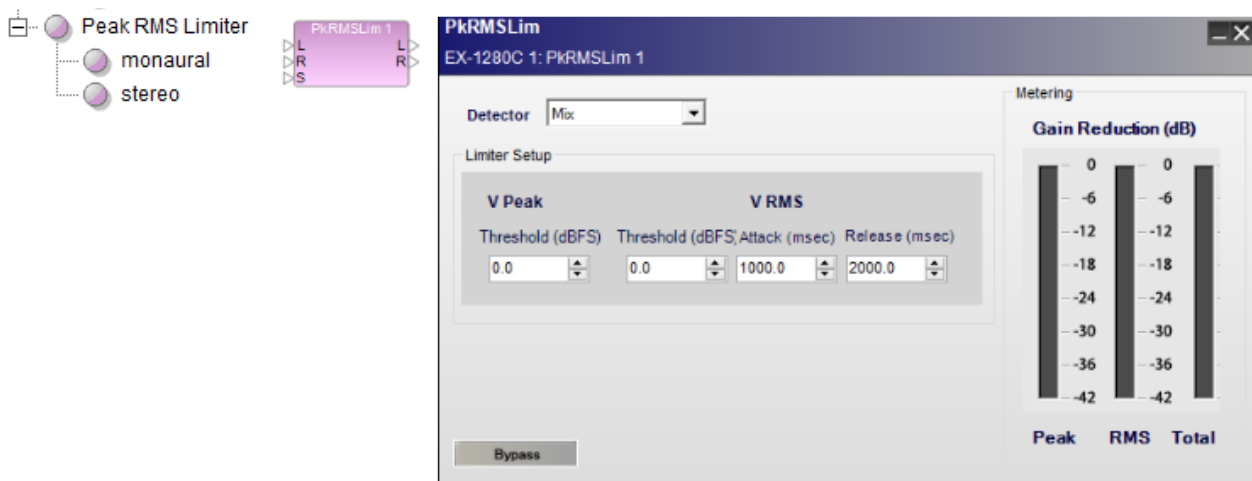

Peak RMS Limiter block and control panel for stereo limiter, with side-chain enabled

Detector - determines which incoming signal is sent to the detector circuit (or trigger) to activate the signal processing.

Input - indicates a monaural signal is the trigger for processing.

Left (Stereo only) - indicates the left signal is the trigger for processing.

Right (Stereo only) - indicates the right signal is the trigger for processing.

Mix (Stereo only) - indicates a left/right signal mix is the trigger for processing.

Side Chain - indicates that an alternate signal connected to the side-chain input is the trigger for processing.

Limiter Setup -

V Peak Threshold (dBFS) - determines the maximum signal level (dBFS) allowed to pass through the signal processing block. Input signal levels above the threshold will be reduced (or hard limited) to the V Peak Threshold value. The default value is 0dBFS and the range of adjustment is -40 to 0 dBFS.

V RMS Threshold (dBFS) - determines the maximum continuous RMS signal level (dBFS) allowed to pass unaltered through the signal processing block. Input signal levels above the threshold level will be reduced to the RMS Threshold value. The default value is 0dBFS and the range of adjustment is -40 to 0 dBFS.

V RMS Attack (msec) - determines the amount of time an RMS signal must exceed the RMS threshold level before the gain of the signal is reduced.

VRMS Release (msec) - determines the amount of time the input signal continues to be reduced after the detection signal drops below the RMS threshold setting.

Metering - Gain Reduction (dB) - meter bars display the amount of gain reduction for the Peak and RMS signal values, as well as the total reduction in gain.

Bypass - forces the channel to remain open at all times by circumventing the detection circuitry.

Predictive Feedback Suppression (PFS)

Predictive feedback suppression (PFS) is an equalization option that detects feedback in the incoming signal and automatically creates and applies filters at relevant frequency bands to reduce and suppress it. The gain levels of these dynamic filters gradually lower as they respond proportionally to the loudness of the feedback. After the feedback subsides and a predetermined length of time passes, the filters will release and return to their original gain levels. You can also apply static filters that will shape the frequency response whether or not feedback is detected.

Note: This is available for fixed-I/O ESP processors and EX-1280C only.

To add a predictive feedback suppression (PFS) block to your project:

1. When viewing the design workspace for a device, make sure the **SP Tool Kit** panel is shown. If it is not, click **Window** and click **Device List** so it is selected.
2. Make sure the **EQs** node is expanded. If it is not, double-click it.
3. Click and drag **Predictive Feedback Suppression** onto the design workspace.



To edit a predictive feedback suppression (PFS) block, do one of the following:

Double-click the **PFS** block in the design workspace.

Right-click the **PFS** block in the design workspace and click **Open**.

Click the **PFS** block in the design workspace and press **Enter**.

Filters

Predictive feedback suppression uses two types of notch filters: static and dynamic. While editing a PFS block, you can create, edit, bypass, or delete each type of filter. You can also convert each type of filter to

the opposite type by using the **Static** and **Dynamic** button next to the **Q/BW** button.

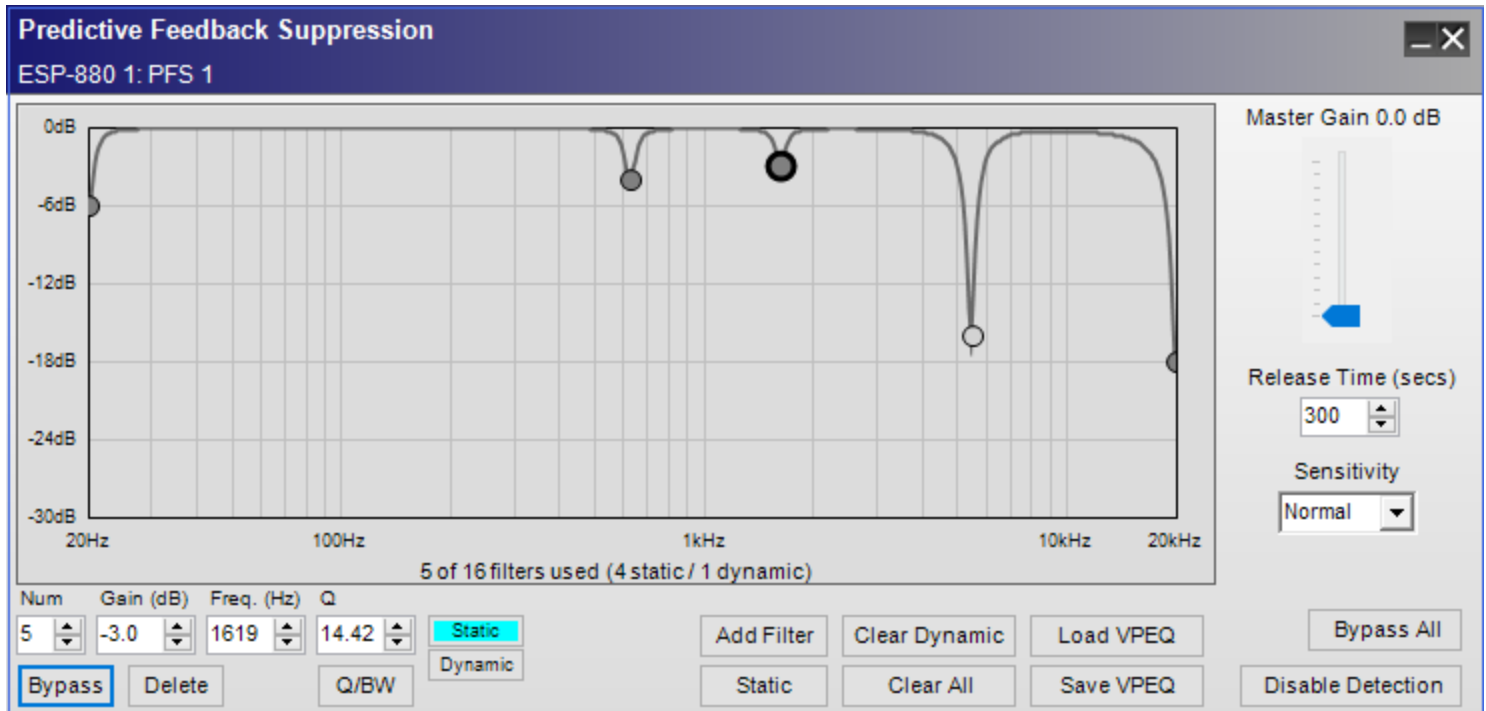

Each PFS block includes the following controls:

VPEQ Graph: A graphical representation of all filters in the PFS block. Each filter is represented by a circle. A variable parametric equalizer (VPEQ) provides extensive control of individual equalization filters to modify the frequency response of a signal. The filters in this VPEQ, however, specifically reduce feedback in the signal. You can control the type, center frequency, bandwidth, and gain of each static filter, whereas dynamic filters will be automatically created and adjusted when feedback is detected.

The X axis represents the frequency range: 20 Hz to 20 kHz. The Y axis represents the range of gain adjustment: 0 dB to -30 dB.

A PFS block can contain 1-16 filters. The total number of filters used—and how many of each type are used—is shown under the graph.

The currently selected filter is outlined by a **bold, black** circle.

A static filter is represented by a **dark gray** circle.

A dynamic filter is represented by a **light gray** circle.

If a filter of either type (static or dynamic) is bypassed, the frequency curve will not dip at that point in the graph.

Master Gain: Adjusts the overall output signal level of the PFS block. Use this setting to increase the gain while ringing out the system. Keep this setting at 0.0 dB during normal live operation. The range of this setting is 0.0 dB to +12 dB.

Release Time (secs): Determines the amount of time the output signal continues to be affected by the dynamic filters after the feedback is no longer detected. The range of this setting is 1 second to 43200 seconds (12 hours). The default setting is 300 seconds (5 minutes).

Sensitivity: Determines how feedback is suppressed based on the type of audio signal. The available settings are **Normal** and **Reduced**. The default setting is **Normal**.

Num: This is the number of the currently selected filter. Use this field to select a filter in the VPEQ. The filters are numbered sequentially in the order they are added.

Gain (dB): Defines how much the filter cuts (reduces the signal at) the frequency band. Alternatively, press and hold **Shift** while clicking and dragging the filter up or down (this restricts the filter's movement in the graph to its vertical axis). The range of this setting is 0.0 dB to -24.0 dB.

Freq. (Hz): Defines the frequency in hertz where the filter is applied. Alternatively, press and hold **Ctrl+Shift** while clicking and dragging the filter left or right (this restricts the filter's movement in the graph to its horizontal axis). The range of this setting is 20 Hz to 20000 Hz.

Q or **BW:** Defines the "width" of the filter as **Q** (resonance) or **BW** (bandwidth). The range of the **Q** setting is 0.10 to 14.42, while the range of the **BW** setting is 0.10 to 6.67. Alternatively, press and hold **Ctrl** while clicking and dragging the filter up or down. You can switch between the **Q** and **BW** settings by clicking **Q/BW**.

Static/Dynamic: Switches the filter type between static and dynamic. The turquoise button indicates the state of the currently selected filter. Alternatively, press and hold **Alt** while clicking the filter, or right-click the filter and then select **Lock Filter** or **Unlock Filter**. (You can convert all filters to static filters by clicking **Static** [under the **Add Filter** button].)

Bypass: Bypasses or reactivates the currently selected filter. Alternatively, right-click the filter and then select **Bypass Filter**. (You can bypass all filters simultaneously or reactivate all filters that were not previously bypassed by clicking **Bypass All** instead.)

Delete: Removes the filter from the VPEQ graph. This cannot be undone. (You can remove all dynamic filters simultaneously by clicking **Clear Dynamic** instead.)

Q/BW: Switches the definition of the filter's "width" between **Q** (resonance) and **BW** (bandwidth).

Add Filter: Adds a filter to the VPEQ graph. A PFS block can contain 1-16 filters.

Static: Converts all filters to static filters. (You can switch the filter type for individual filters by selecting a filter and clicking **Static** or **Dynamic** instead.)

Clear Dynamic: Removes all dynamic filters from the VPEQ graph. This cannot be undone. (You can remove individual filters by clicking **Delete** instead.)

Clear All: Removes all active static and dynamic filters. (You can remove individual filters by clicking **Delete** instead.)

Load VPEQ: Opens your computer's browser window so you can select and load a previously saved VPEQ, which includes all filters and their settings shown in a PFS block. See [Saving & Loading VPEQ Files](#) to learn more.

Save VPEQ: Saves the current VPEQ, which includes all filters and their settings shown in the current PFS block. See [Saving & Loading VPEQ Files](#) to learn more.

Bypass All: Bypasses all filters simultaneously or reactivates all filters that were not previously bypassed. Bypassing all filters will also disable **Master Gain** and **Disable Detection**.

Disable Detection: Disables or enables feedback detection. When detection is disabled, the button will be green, and the PFS block will not detect any feedback that occurs (static filters will still affect the audio signal, and any currently active dynamic filters will remain active until the release time has elapsed). When detection is enabled, the button will be gray, and the PFS block will detect feedback in the incoming signal and automatically create and apply filters at relevant frequency bands to reduce and suppress it.

Static

A static filter is always active—regardless of the incoming signal’s volume or frequency content—unless you bypass or delete it.

To convert a static filter to a dynamic filter, do one of the following:

- Right-click it and select **Unlock Filter**.

- Click it or use the **Num** field to select it, and then click **Dynamic** (next to the **Q/BW** button).

You can convert all filters to static filters by clicking **Static** (under the **Add Filter** button) instead.

Dynamic

A dynamic filter is created, activated, and deactivated automatically. As described earlier, these filters respond proportionally to the loudness of feedback detected in the incoming signal. They release after the feedback subsides and the predetermined release time elapses.

You can also create dynamic filters manually by unlocking static filters.

To convert a dynamic filter to a static filter, do one of the following:

- Right-click it and select **Lock Filter**.

- Click it or use the **Num** field to select it, and then click **Static** (next to the **Q/BW** button). Alternatively, change its **Gain**, **Frequency**, or **Q/BW** setting.

To enable or disable feedback detection, click **Disable Detection** in the lower-right corner. When detection is disabled, the button will be green, and the PFS block will not detect any feedback that occurs. This essentially bypasses all dynamic filters, though static filters will still affect the audio signal. When detection is enabled, the button will be gray, and the PFS block will detect feedback in the incoming signal and automatically create and apply filters at relevant frequency bands to reduce and suppress it.

Saving & Loading VPEQ Files

A VPEQ file (*.peq) contains all settings in a PFS block, including all filters and values.

To save the current PFS block as a VPEQ file, click **Save VPEQ**. In the window that appears, select a location to save the file, enter a file name, and then click **Save** or **Cancel**.

To load a VPEQ file to the current PFS block, click **Load VPEQ**. In the window that appears, select the location of the file, and then click **Open** or **Cancel**.

Note: The *.peq file extension used by PFS blocks is also used by VPEQ (parametric EQ) blocks. You can load a VPEQ file from a VPEQ block into a PFS block, but you may see an error message because PFS blocks do not support all settings of a VPEQ block. The error message will list the unsupported settings. If you see this message, select **Clamp**, **Drop**, or **Cancel**:

- Clamp:** Forces the loaded settings to conform those supported in the PFS block.

- Drop:** Loads all settings except for those unsupported in the PFS block.

- Cancel:** Cancels the loading of all settings.

Routers

Routers direct individual inputs to one or more outputs within a programmable SP block.

Setting the Number of Ports

To set the number of input and output ports for a Router block:

1. Drag the Router block into Signal Processing View.
2. In the Router dialog, you can select from list of pre-defined port configurations, such as 2x2, 2x4, 8x8, 8x16 and many others. Alternatively, you can select or type in the number of input and output ports (up to 32 each, max) using the Input and Output ports selector controls.

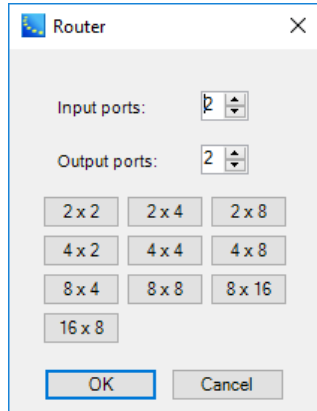

3. Click **OK** to add the block to the Signal Processing View.

You can modify the number of inputs or outputs at any time by right clicking on the block and selecting **Change Channel Count**. The numbers of input or output channels may be individually set between 2 and 32.

Router Block and Control Panel

Double-click on the Router block in Signal Processing View to open its control panel.

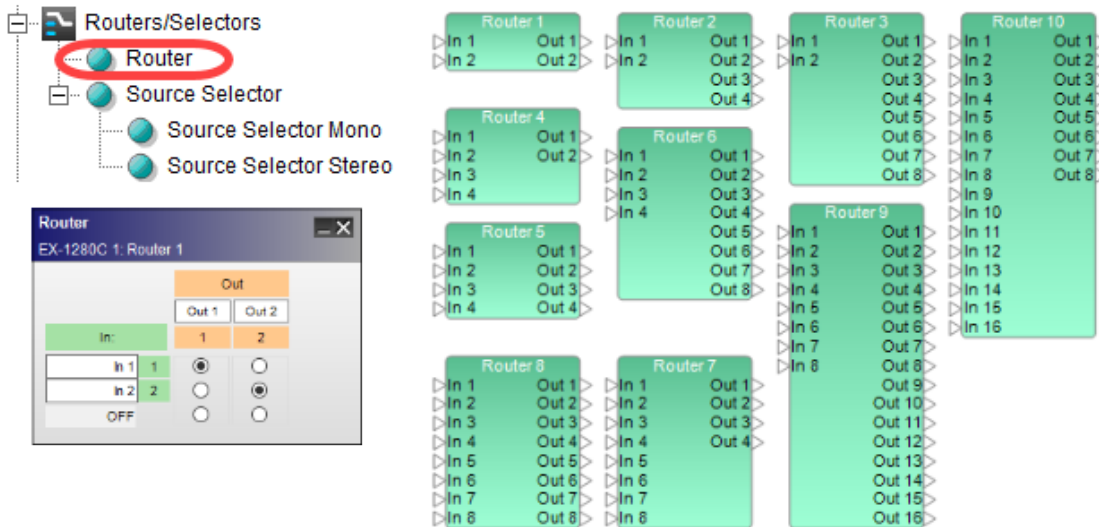

Router processing blocks and 2x2 control panel

The **Router control panel** provides the following options:

Input and Output Labels – allows direct entry of user defined labels for inputs or outputs.

Output Assignment – cross-point radio buttons select which input channel is routed to each output channel. To mute audio for an output channel, select the OFF cross-point on the bottom row under the input channels.

Source Selector

The Source Selector routes one of its input signals to an output channel. Both monoaural and stereo source selectors are available.

Setting the Number of Channels

To set the number of input channels for a Source Selector block:

1. Drag the Mono or Stereo Source Selector block into Signal Processing View.
2. In the Source Selector dialog, you can select from list of pre-defined input channels. Alternatively, you can select or type in the number of input channels (up to 16 max) using the channels selector controls.

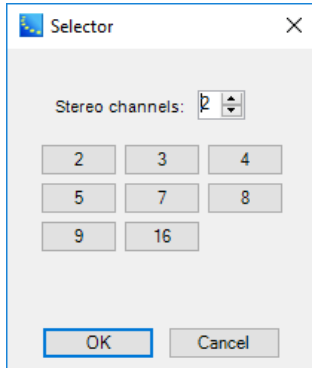

3. Click **OK** to add the block to the Signal Processing View.

You can modify the number of input channels by right clicking on the block and selecting **Change Channel Count**. The number of input channels may be set between 2 and 32.

Source Selector Block and Control Panel

Double-click on the Source Selector block in Signal Processing View to open its control panel.

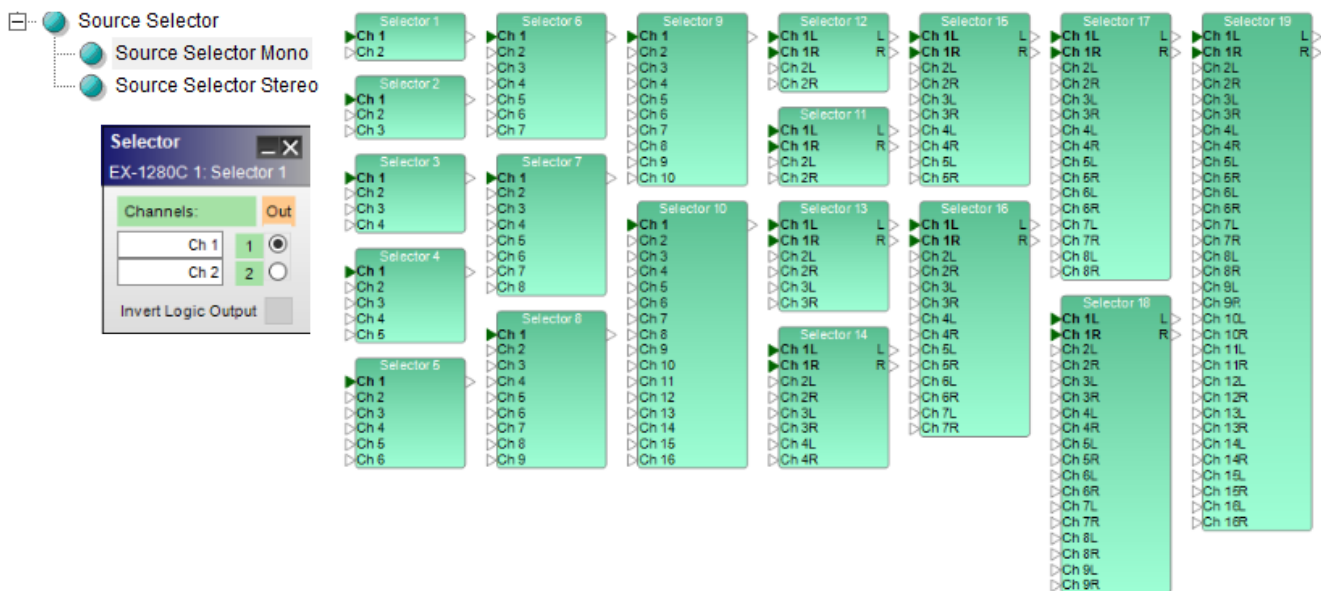

Source Selector processing blocks and mono - 2-channel control panel

The Source Selector control panel provides the following options:

Channel Labels– displays current channel name and allows direct entry of user-defined labels for channels.

Select Channel – in the Out column, the input channel may be selected by clicking on the cross-point, or by using the up/down arrow keys on the keyboard.

Invert Logic Output - when this option is selected, the corresponding logic output is set **Low** when a particular input channel is selected. All other logic outputs for this block will be **High**. For more information on logic support for Source Selector blocks, see [Logic and Testing Support for SP Blocks](#).

Speaker EQ

Speaker EQ signal processing blocks provide pre-configured equalization settings for Bose loudspeakers and bass arrays. Four Speaker EQ SP block types are provided:

- Single speaker output
- Crossover with high and low frequency speaker outputs
- Two-element bass array configurations
- Four-element bass array configurations

Double-click on the Speaker EQ block in Signal Processing View to open its control panel.

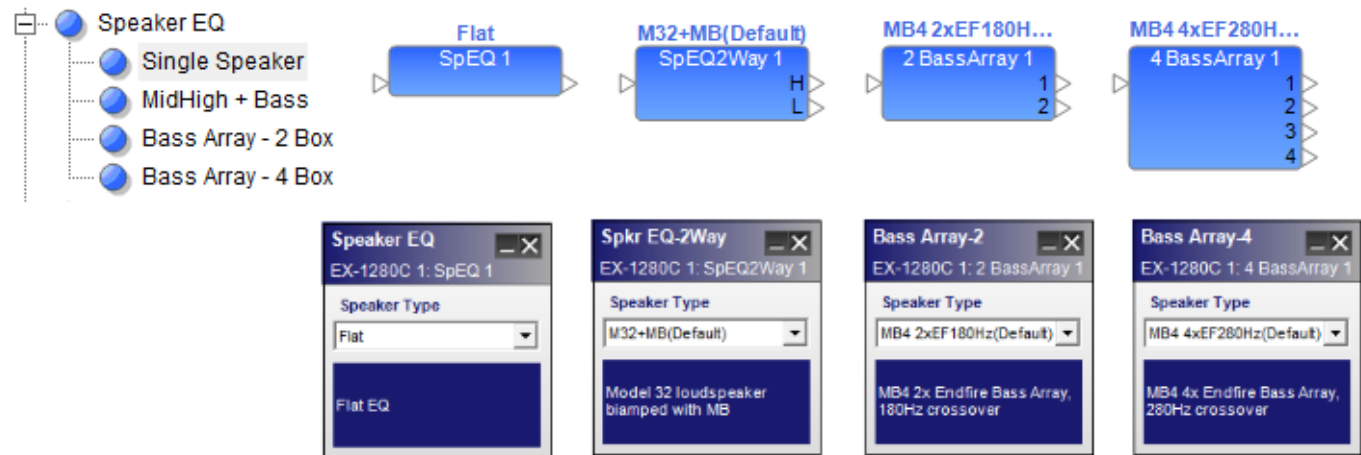

Speaker EQ processing blocks and control panels

Each **Speaker EQ control panel** provides the following options:

Speaker Type – drop down list with a selection of loudspeakers appropriate for the chosen EQ type.

EQ Description – provides a detailed list of product and configuration options unique to each speaker type.

Speaker PEQ (Bose Speaker Parametric EQ)

The Bose Speaker Parametric EQ is an advanced signal processing block to permit loudspeaker equalization, and bandpass within a single design element.

Double-click on the Speaker EQ block in Signal Processing View to open its control panel.

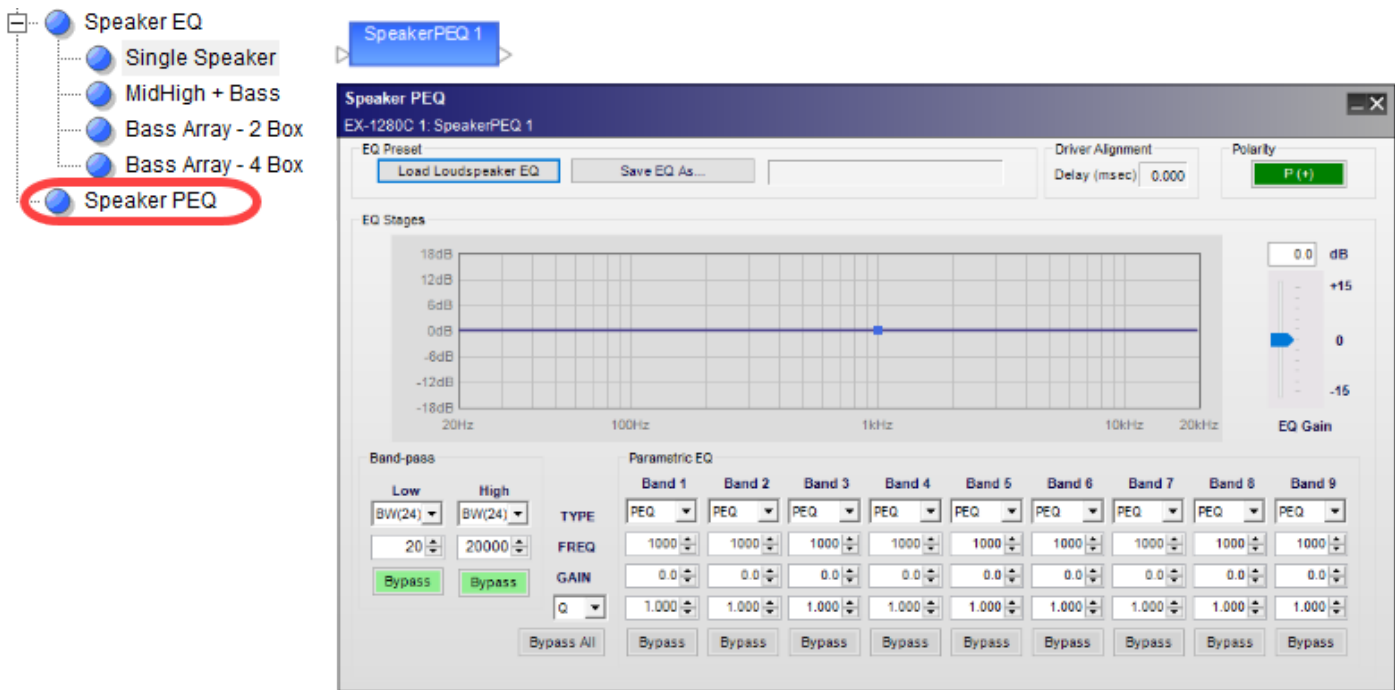

Bose Speaker Parametric EQ, processing block and control panel

The Bose Speaker Parametric EQ control panel provides the following options:

EQ Preset – load or save pre-defined loudspeaker processing values.

Load Loudspeaker EQ – populates control panel with factory-calibrated, pre-defined settings for Bose loudspeakers. Bose loudspeakers are locked when loaded in to the processing block. Use **Save EQ As** to unlock the settings. The original locked preset will remain unchanged.

Save EQ As – allows user to save EQ and loudspeaker settings to an external .SEQ file.

EQ Stages – displays a graphical representation of adjustable EQ filter settings in both frequency and level. The line varies according to values adjustable within the Band-pass and Parametric EQ sections.

Band-pass – determines the low-pass and high-pass filter settings for the loudspeaker processor according to filter type and frequency.

Parametric EQ – provides adjustable controls for defining individual parametric filters. Available options are:

Type – determines the filter parameters used for the EQ. Four types of filters are available to define the filter. Options include:

PEQ – enables parametric EQ filter options for this band.

High Shelf - enables high-frequency shelving filter options for this band.

Low Shelf - enables low-frequency shelving filter options for this band.

Notch - enables notch filter (cut only) options for this band.

FREQ – adjusts the center frequency of the filter via direct entry or the up and down buttons.

GAIN – sets the individual filter gain from -20dB to +20dB.

BW/Q – selects the unit of measure for filter width to Q or Bandwidth (octaves).

Bypass – disables this specific filter from affecting the signal chain.

EQ Gain – provides up to +/-15 dB of output gain adjustment for the Parametric EQ stage. This setting may also be referred to as Make-up Gain.

Driver Alignment –adds a single delay to all loudspeakers connected to this block. This is a read-only parameter for Bose loudspeaker presets.

Signal Polarity Control - Inverts the polarity of the signal. Default value is positive (+) or non-inverted. When selected, the signal polarity is negative (-) or inverted. Button color is used to indicate current state with GREEN = non-inverted and RED = inverted.

Standard Room Combining (StRC)

Standard Room Combining (StRC) is a simpler alternative to the Conference Room Combining (CRC). This is useful if an application does not require the advanced, complex mixing features of the conference room router (CRR). Instead, multiple inputs are mixed down to just one channel with a single Volume control and Mute button.

IMPORTANT: Standard room combiners and conference room combiners cannot belong to the same RC Group.

IMPORTANT: All inputs and outputs for standard room combiner (StRC) and background music (BGM) blocks are mono.

Note: This is available for fixed-I/O ESP processors and EX-1280C only.

Creating & Managing StRC Blocks

To add a standard room combiner (StRC) block to your project:

1. When viewing the design workspace for a device, make sure the **SP Tool Kit** panel is shown. If it is not, click **Window** and click **Device List** so it is selected.
2. Make sure the **Mixers** node is expanded. If it is not, double-click it.
3. Click and drag **Standard Room Combiner** onto the design workspace.
4. In the **Room Combine: Configuration** window that appears, use the controls to set up the audio routing of the rooms:

The screenshot shows the 'Room Combine: Configuration' dialog box. It features a title bar and several configuration sections. The 'Number of Rooms' section has a spinner control set to 8. The 'RC Group' section has a dropdown menu set to 1. The 'Input' section has a spinner control set to 6, and the 'Output' section has a dropdown menu set to 'Main Out'. Below these are lists of 'Input 1' through 'Input 6' and 'BGM 1' through 'BGM 4', each with a small expand/collapse icon to its left. At the bottom of the dialog are three buttons: 'OK', 'Cancel', and 'Continue to Build'.

Number of Rooms: This defines the total number of rooms. The range of this setting is 1 room to 16 rooms. An StRC block will be created for each room.

RC Group: This is the RC Group to which the room combiner is assigned.

Input: This defines how many inputs will be available to be routed to the combined rooms. The range of this setting is 1 input to 12 inputs. All of these inputs are mono.

Output: This is the mono output signal to be routed to the combined rooms.

BGM: This defines how many BGM sources will be available to be routed to the combined rooms. The range of this setting is 0 sources to 12 sources. All of these inputs are mono. See [Selecting Background Music \(BGM\)](#) to learn more about this.

OK: Click this to create the configuration.

Cancel: Click this to cancel the configuration.

Continue to Build: Click this to create the configuration and open the Room Combine Layout window (see [Combining Rooms](#) to learn about this).

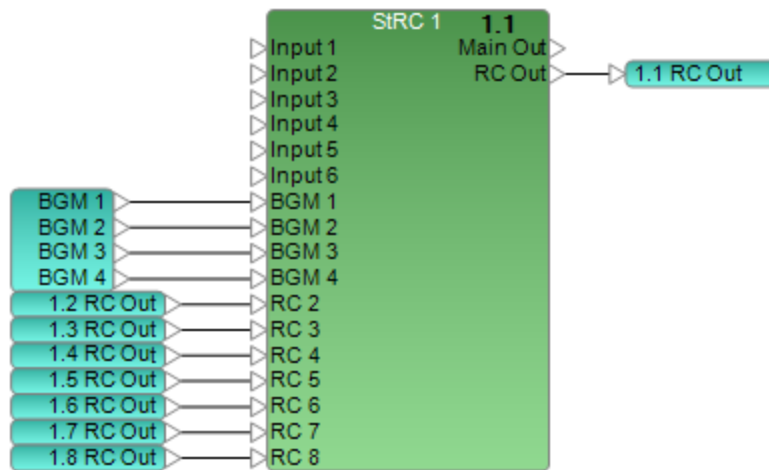

Each StRC block consists of:

Input: The available mono inputs (determined by the **Inputs** field).

BGM: The available mono background music (BGM) inputs (determined by the **BGM** field).

RC: Mono inputs that receive signals from the RC Outs of all other rooms in the RC Group (determined by the **Number of Rooms** field). If you add or remove rooms to or from the RC Group, these inputs will change to match the RC Outs of those rooms.

Main Out: The signal sent from this mono output is a mix of the block's standard inputs, BGM inputs, and RC inputs.

RC Out: The signal sent from this mono output is a mix of the StRC block's standard inputs, BGM inputs, and RC inputs. This signal is automatically connected to the corresponding RC input of all other StRC blocks in the RC Group.

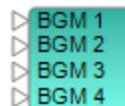

A BGM block consists of:

The available mono background music (BGM) inputs (determined by the **BGM** field).

To copy an StRC block, do one of the following:

Right-click the **StRC** block in the design workspace and click **Copy**.

Click the **StRC** block in the design workspace, click the **Edit** menu, and click **Copy**.

Click the **StRC** block in the design workspace, and press **Ctrl+C**.

To cut an **StRC** block, do one of the following:

Right-click the **StRC** block in the design workspace and click **Cut**.

Click the **StRC** block in the design workspace, click the **Edit** menu, and click **Cut**.

Click the **StRC** block in the design workspace, and press **Ctrl+X**.

Note: The RC inputs of all StRC blocks in the RC Group will automatically update to match the number of current rooms.

To paste an StRC block, do one of the following:

Right-click anywhere in the design workspace and click **Paste**.

Click anywhere in the design workspace, click the **Edit** menu, and click **Paste**.

Click anywhere in the design workspace, and press **Ctrl+V**.

Note: The RC inputs of all StRC blocks in the RC Group will automatically update to match the number of current rooms.

To duplicate an StRC block, do one of the following:

Right-click the **StRC** block in the design workspace and click **Duplicate**.

Click the **StRC** block in the design workspace, click the **Edit** menu, and click **Duplicate**.

Click the **StRC** block in the design workspace, and press **Ctrl+D**.

Note: The RC inputs of all StRC blocks in the RC Group will automatically update to match the number of current rooms.

To edit a standard room combiner (StRC) block, do one of the following:

Double-click the **StRC** block in the design workspace.

Right-click the **StRC** block in the design workspace and click **Open**.

Click the **StRC** block in the design workspace and press **Enter**.

See [Adjusting Volume & Muting](#) to learn how to edit each StRC block.

Selecting Background Music (BGM)

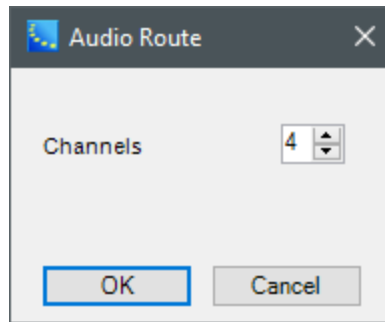

To change the number of BGM channels:

1. Right-click the **BGM** block in the design workspace and click **Change Channel Count**.
2. In the **Audio Route** window that appears, use the **Channels** field to change the number of channels.
3. Click **OK** to confirm your choice, or click **Cancel** to close the window without making any changes.

IMPORTANT: If you add or remove channels to or from the BGM block, the available BGM sources for each StRC block will change to match the BGM block, but the number of BGM inputs on each StRC block will remain the same.

Adjusting Volume & Muting

You can edit the volume levels, muting, and background music sources of all rooms in the layout (RC Group) by editing any of the StRC blocks in that RC Group.

To edit a standard room combiner (StRC) block, do one of the following:

- Double-click the **StRC** block in the design workspace.
- Right-click the **StRC** block in the design workspace and click **Open**.
- Click the **StRC** block in the design workspace and press **Enter**.

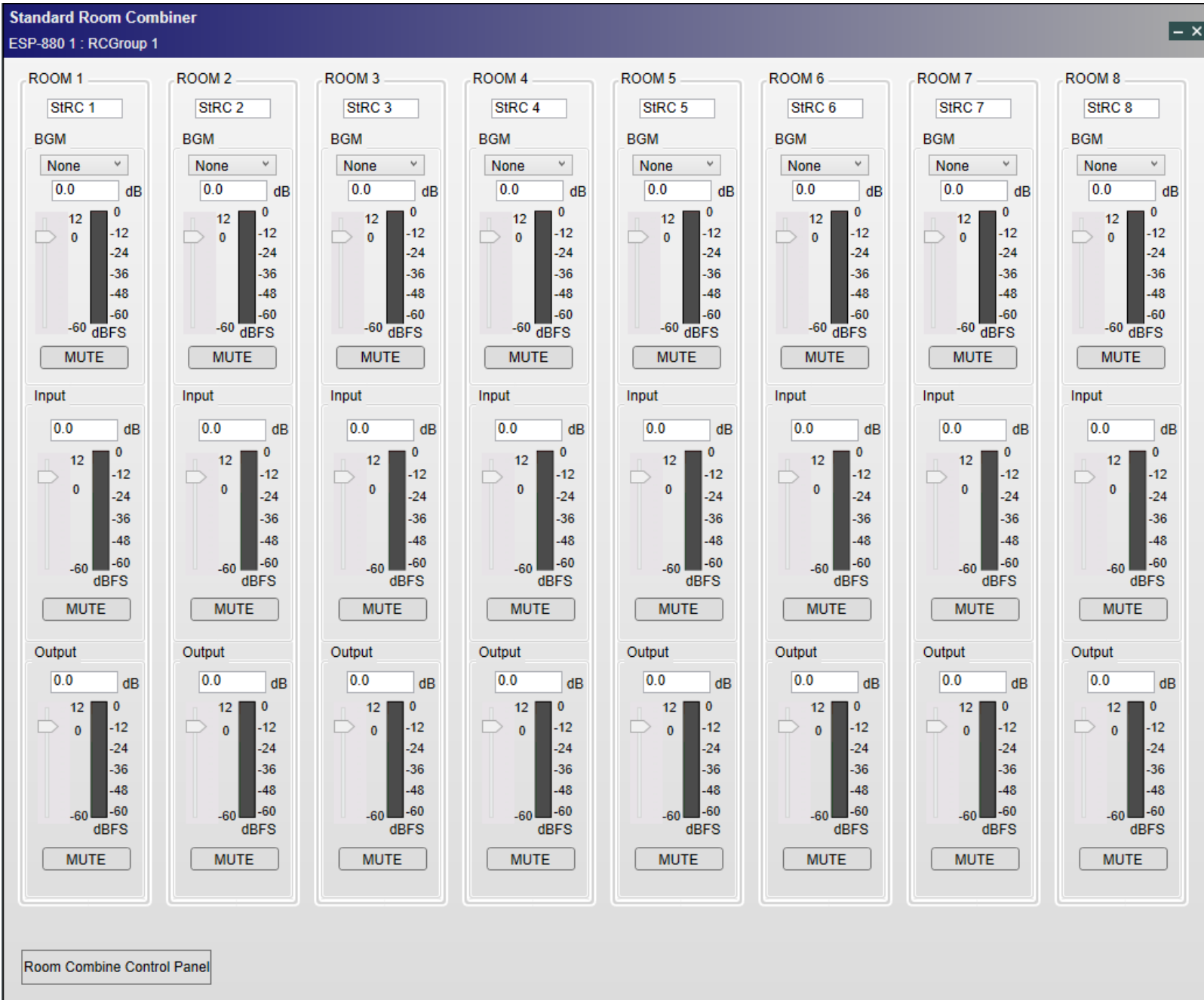

The **Standard Room Combiner** window that will appear includes the following controls:

Room Controls: Each room in the layout can be controlled by a vertical “channel strip” shown in this window. Each channel strip includes the following controls:

Room Label: Shows the name of the room. You can click this field and enter a different name.

BGM: The background music channel (mono).

Source: Sets the source of the background music (BGM). You can select any of the BGM outputs you created for the StRC block or **None** (no music).

Volume Level: Adjusts the output signal level of the background music (BGM). The range of this setting is $-\infty$ dBFS to +12 dBFS.

Mute: Mutes or unmutes the background music (BGM) signal. The button is red while muted and gray while unmuted.

Input: The main input channel (mono).

Volume Level: Adjusts the input signal level of the microphones. The range of this setting is $-\infty$ dBFS to +12 dBFS.

Mute: Mutes or unmutes the input signal. The button is red while muted and gray while unmuted.

Output: The main output channel (mono).

Volume Level: Adjusts the overall output signal level of the room. The range of this setting is $-\infty$ dBFS to +12 dBFS.

Mute: Mutes or unmutes the output signal. The button is red while muted and gray while unmuted.

Scroll Bar: Scrolls across the array of room channel strips. Four room channel strips are visible at a time.

Room Combine Control Panel: Opens the **Room Combine** window. See [Combining Rooms](#) to learn about this.

IMPORTANT: When combining rooms with different settings for the volume level, mute state, and/or BGM source, the combined room will (1) use the lowest volume level, (2) be muted if any of the original rooms is muted, and (3) use the BGM source of the room with the lowest number.

Creating & Editing a Room Layout

You can use the grid in the **Room Combine Layout** window to configure the size and layout of the rooms and combine them with each other.

To open the Room Combine Layout window, click **Edit Room Layout** in the **Room Combine** window.

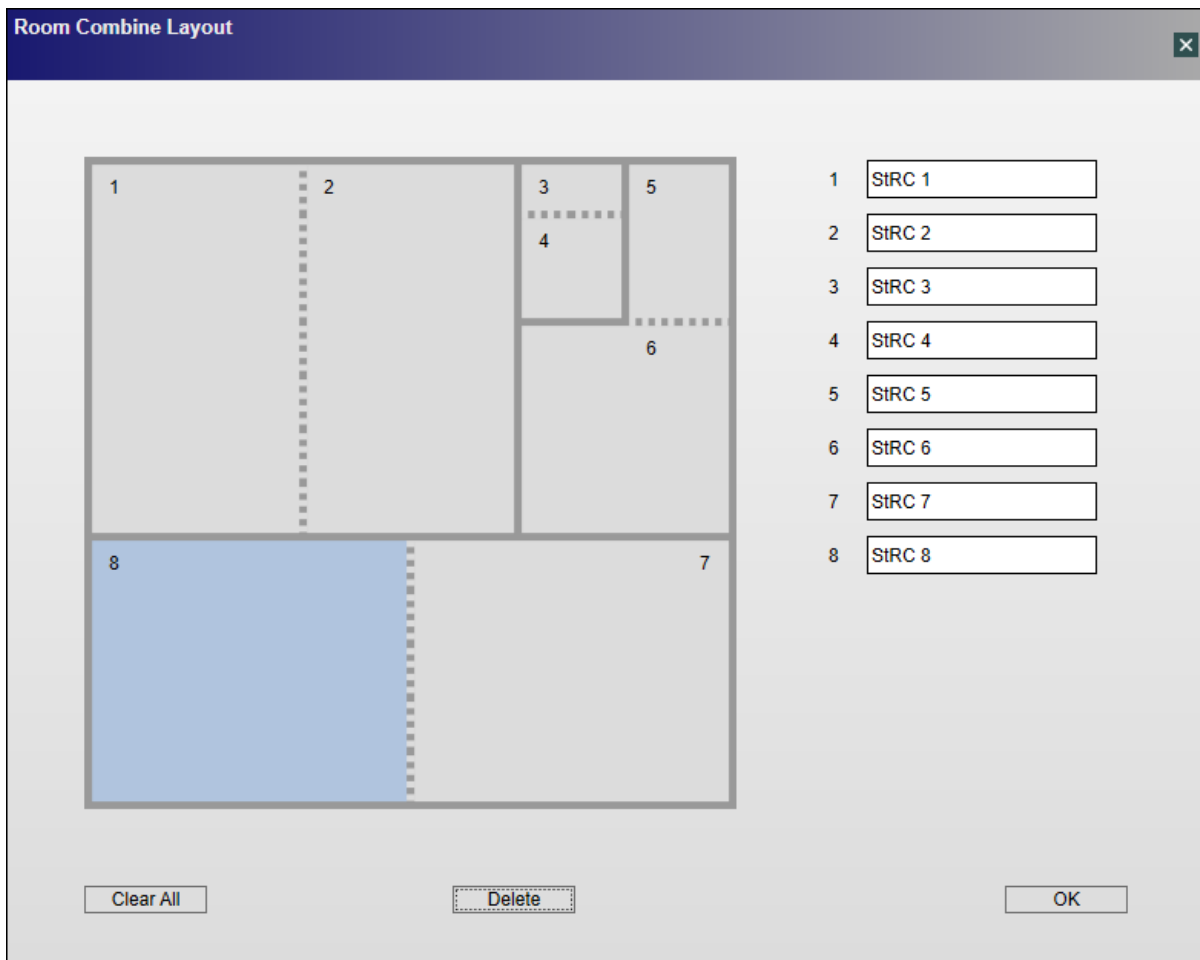

To edit the name of the room, click the room label field and enter a different name.

To assign a number to a room, click an unassigned room square.

To remove a wall, click it. You can create square or rectangular rooms only.

Note: If clicking a wall would create an irregularly shaped room, then more than one wall will be removed (to create a square or rectangular room).

To replace a wall with a partition, click a wall between two numbered rooms. The solid line will change to a dotted line, indicating a partition instead of a standard wall.

To reset the walls and room number assignment of the selected room only, click **Delete**.

To reset all walls and room number assignments, click **Clear All**.

The **Room Combine Layout** window includes the following controls:

Room Grid: This grid is a visual representation of the combined rooms. See the instructions above to learn how to edit the layout.

Room Labels: These are the names of the rooms. You can click each field and enter a different name.

Clear All: Resets all changes you have made to the layout, including the rooms' number assignments.

Delete: Resets the changes you have made to the selected room only, including its number assignment.

OK: Locks the combined room layout.

Combining Rooms

You can use the grid in the **Room Combine** window to combine rooms in the layout with each other.

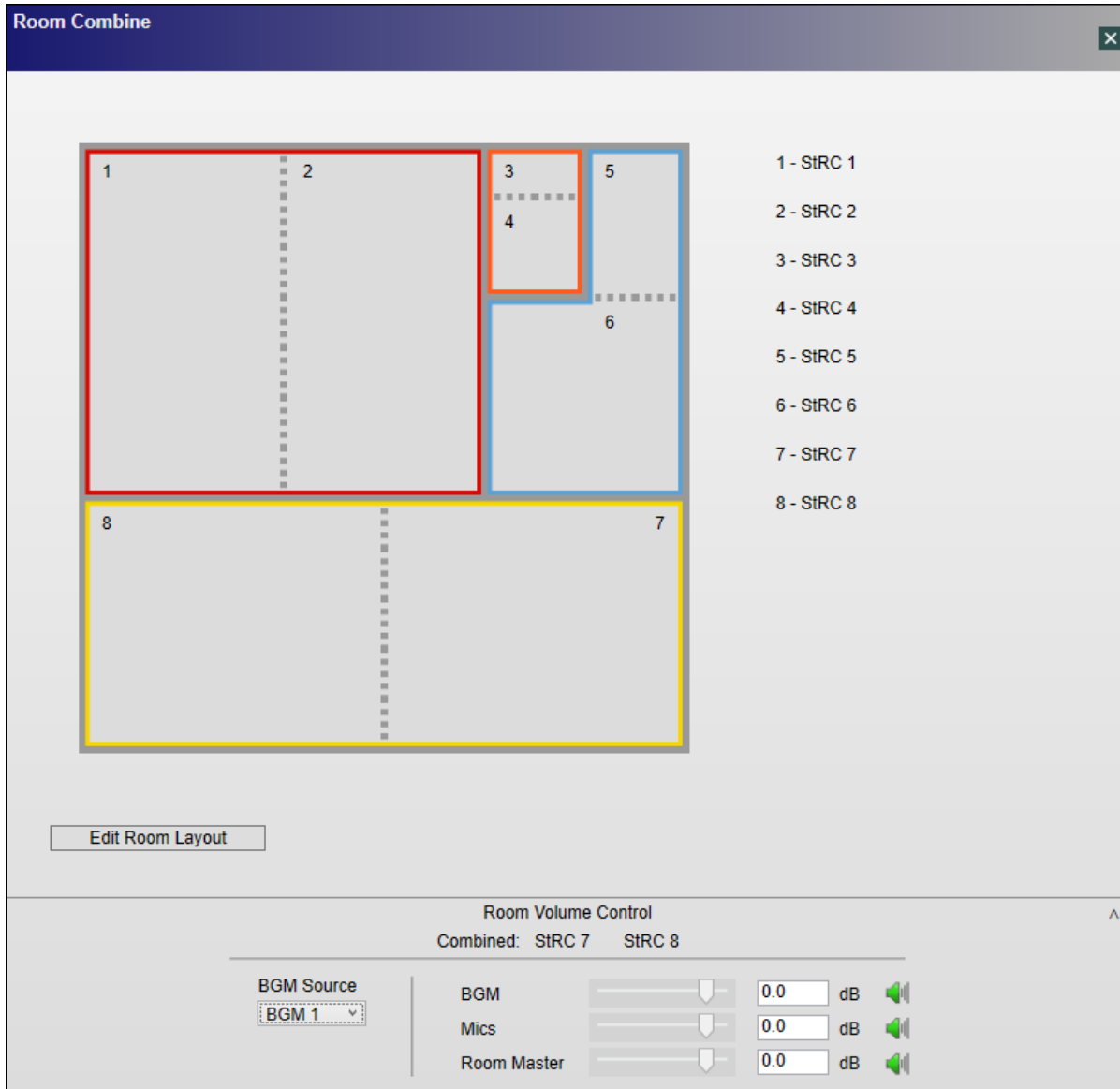

To combine two rooms, click the first one to select it, and then press and hold **Ctrl** while clicking the second room. The two rooms will be outlined by a colored line. You can repeat this process to add more rooms.

To remove a room from a combination, click the one of the rooms in the combination to select it, and then press and hold **Ctrl** while clicking the room you want to remove. The colored outline will disappear. You can repeat this process to remove more rooms from the combination.

While the room layout is locked (i.e., you are unable to edit it), the **Room Combine Layout** window includes the following controls:

Room Grid: This grid is a visual representation of the combined rooms.

Room Labels: The names of the rooms.

Edit Room Layout: Unlocks the combined room layout, allowing you to edit it.

Room Volume Control: Click this tab to collapse or expand it.

Combined: The name of the selected room.

Outputs: The source of the background music (BGM). See [Adjusting Volume & Muting](#) to learn how to change it.

BGM: The output signal level of the background music (BGM). The volume icon is gray while the signal is muted or green while it is unmuted. See [Adjusting Volume & Muting](#) to learn how to change these settings.

Mics: The input signal level of the microphones. The volume icon is gray while the signal is muted or green while it is unmuted. See [Adjusting Volume & Muting](#) to learn how to change these settings.

Room Master: The overall output signal level of the room. The volume icon is gray while the signal is muted or green while it is unmuted. See [Adjusting Volume & Muting](#) to learn how to change these settings.

Standard Mixer

The Standard Mixer SP block is used to combine (mix) and route input signals to output channels. Gain and mute settings are available for each input and output.

Setting the Number of Ports

To set the number of input and output ports for a Standard Mixer block:

1. Drag the Standard Mixer block into Signal Processing View.
2. In the Standard Mixer dialog, you can select from list of pre-defined port configurations, such as 2x1, 4x1, 8x8, 16x24 and many others. Alternatively, you can select or type in the number of input and output ports (up to 32 each, max) using the Input and Output ports selector controls.

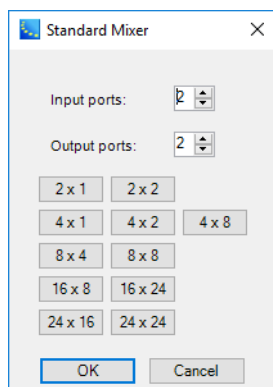

3. Click **OK** to add the block to the Signal Processing View.

You can modify the number of inputs and outputs to a block by right clicking on the block and selecting **Change Channel Count**. You can then modify the number of channels, up to a maximum of 32 inputs or outputs.

Standard Mixer Block and Control Panel

Double-click on the Standard Mixer block in Signal Processing View to open its control panel.

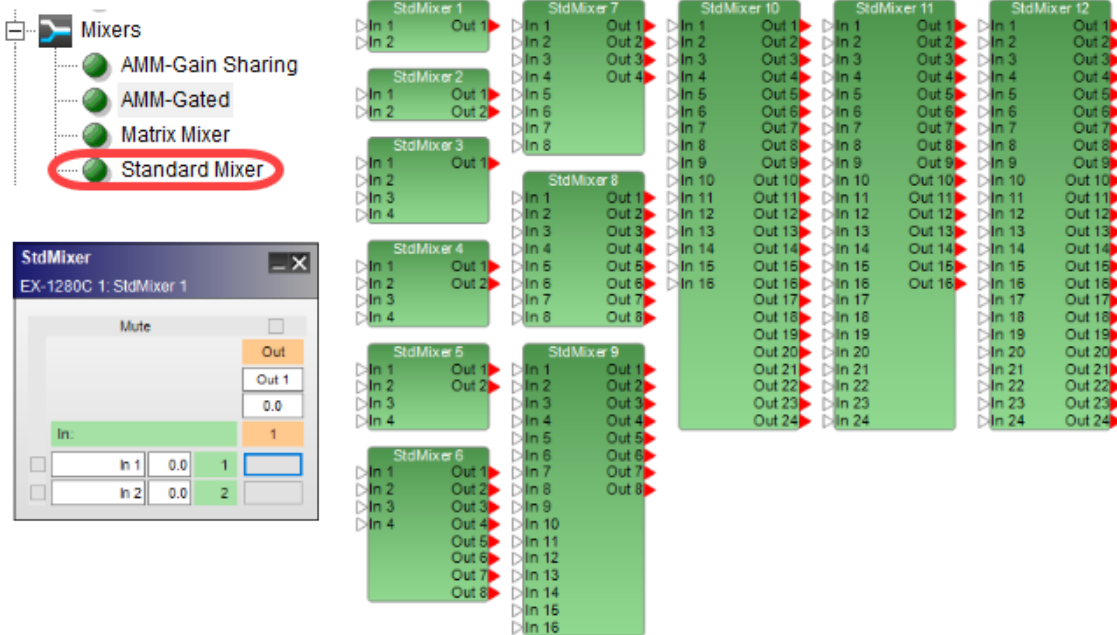

Standard Mixer processing blocks and 2x1 control panel

The **Standard Mixer control panel** provides the following options:

Input and Output Labels– allow direct entry of user-defined labels for inputs or outputs.

Input Level – is a direct entry field for adjusting the input signal. The range of adjustment is from $-\infty$ to +12dB and the input section is shaded in green.

Output Level – is a direct entry field for adjusting the output signal. The range of adjustment is from $-\infty$ to +12dB and the output section is shaded in orange. A level of $-\infty$ may be set by entering a value less than -60.

NOTE: To enable $-\infty$ in a direct entry field without a gain slider, enter any value less than -60dB.

Assign – creates a routing path between an input and an output. Select the assign box at the intersection of the two channels to permit audio to pass from input to output. When an assignment is made, the assign box turns blue.

Mute – silences the signal on a specific input or output and prevents the signal from passing to the next signal processing block in the design. When a Mute box selected, it turns red.

Test/Measurement SP Blocks

The Test/Measurement category of signal processing blocks provides three types of dedicated signal generators:

- Sine Generator
- Noise Generator
- Sweep Generator

Double-click on a block in the Test/Measurement category in Signal Processing View to open its control panel.

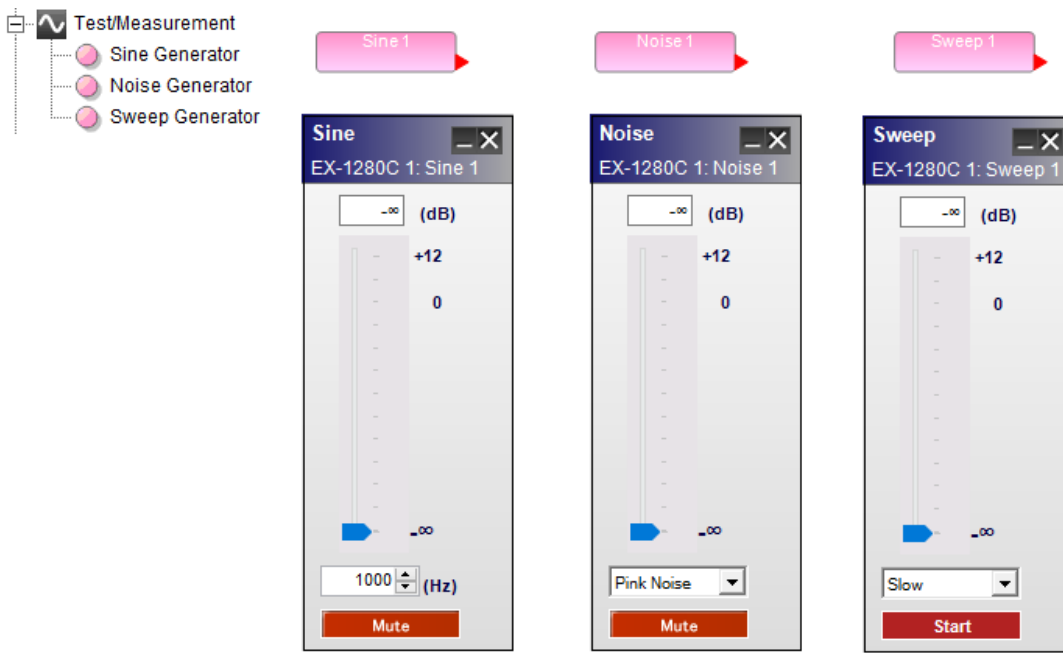

Test/Measurement processing blocks and control panels

The **Test/Measurement processing block control panels** provide the following options:

Sine Generator – outputs a sine wave with variable level and frequency.

Generator Value – permits direct entry of desired output signal level in dB. Range of adjustment matches and tracks the generator gain slider.

Generator Gain Slider – adjusts the output signal level delivered to the next signal processing block. The range of adjustment is from $-\infty$ to +12dB.

Frequency – permits direct entry of desired output frequency in hertz. The range of adjustment is from 20 Hz to 20 kHz.

Mute – silences the signal generator. When Mute is enabled, the control panel button is red (default).

Noise Generator – outputs two types of broadband noise with variable level.

Generator Value – permits direct entry of desired output signal level in dB. Range of adjustment matches and tracks the generator gain slider.

Generator Gain Slider – adjusts the output signal level delivered to the next signal processing block. The range of adjustment is from $-\infty$ to +12dB.

Noise Type – provides a selector to choose between the two available types of noise, Pink noise and White noise.

Mute – silences the signal generator. When Mute is enabled, the control panel button is red (default).

Sweep Generator – outputs a swept sine wave from 20 Hz to 20 kHz with variable level and speed.

Generator Value – permits direct entry of desired output signal level in dB. Range of adjustment matches and tracks the generator gain slider.

Generator Gain Slider – adjusts the output signal level delivered to the next signal processing block. The range of adjustment is from $-\infty$ to +12dB.

Sweep Speed – provides a selector to choose between the two available rates of sweep, Fast or Slow.

Start / Stop – enables or disables the signal generator.

Tone Control EQ

The Tone Control EQ boosts or cuts the output level at the low, mid, and high frequency bandwidths. Double-click on the Tone control EQ block in Signal Processing View to open its control panel.

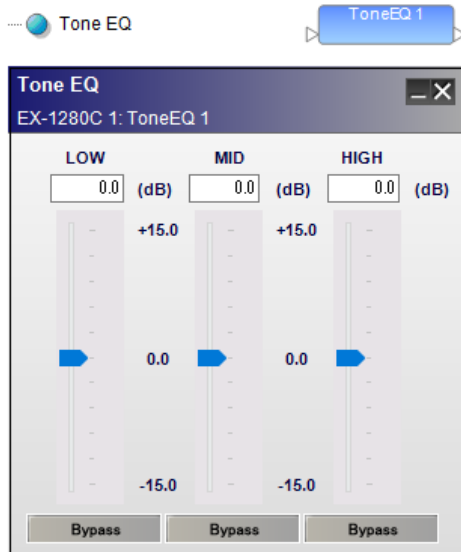

Tone control EQ, processing block and control panel.

The **Tone control EQ control panel** provides the following options:

LOW – controls a 200Hz 6dB per octave shelving filter.

Gain slider – is adjustable to boost or cut the level from -15 dB to +15 dB. Enter a boost or cut value in the input box above this slider to set the gain.

Bypass – disables this specific filter from affecting the signal chain.

MID – controls a 1000Hz, one octave parametric filter. (Q=1.414 or BW=1.0).

Gain slider – is adjustable to boost or cut the level from -15 dB to +15 dB. Enter a boost or cut value in the input box above this slider to set the gain.

Bypass – disables this specific filter from affecting the signal chain.

HIGH – controls a 5000Hz 6dB per octave shelving filter.

Gain slider – is adjustable to boost or cut the level from -15 dB to +15 dB. Enter a boost or cut value in the input box above this slider to set the gain.

Bypass – disables this specific filter from affecting the signal chain.

PowerMatch® 8500/8250/4500/4250

PowerMatch® Configurable Professional Power Amplifier Devices

There are eight PowerMatch devices in the Device List shown below; Four available via a network/USB connection and four available via a USB connection only.

While signal processing between networked and USB-only versions of PowerMatch amplifier models are identical, USB versions do not include an Ethernet network connection and may only be configured using its USB connection.

The devices are added to the Project View using the same drag and drop mechanism as other devices within the ControlSpace® Designer™ software.

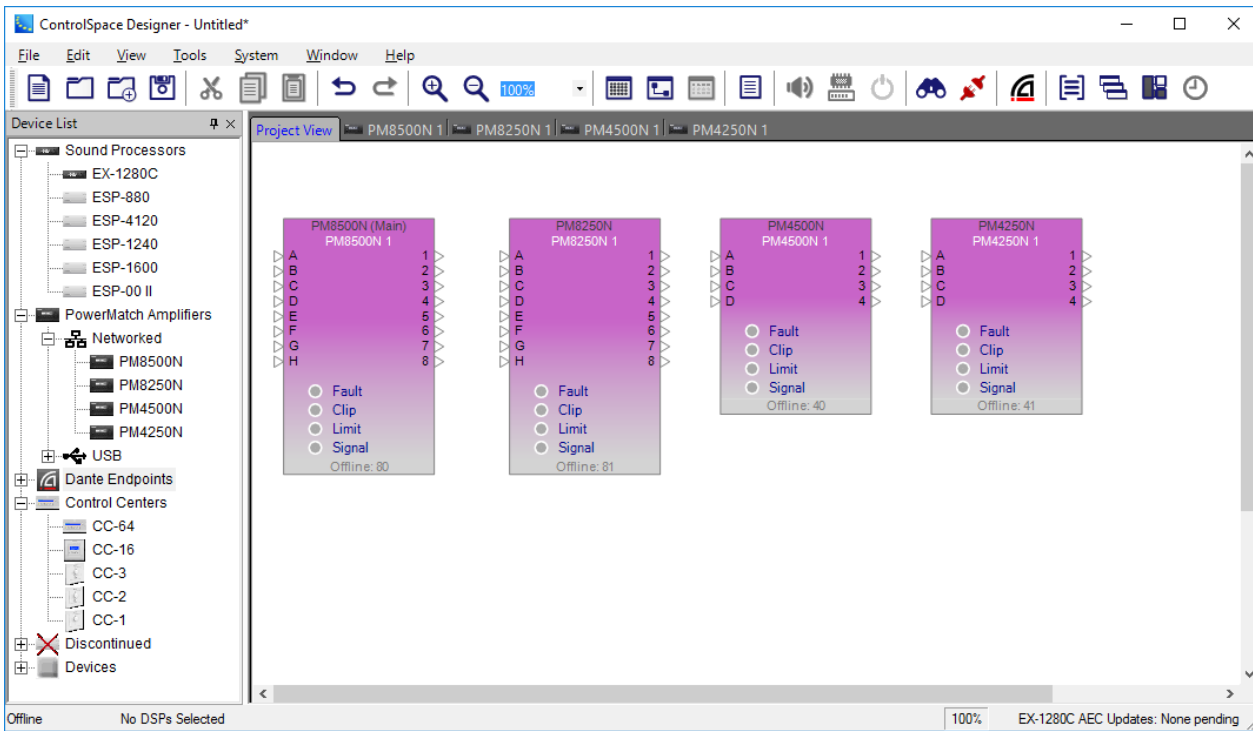

PowerMatch networked amplifier blocks

Amplifier Properties

To view the device properties for a PowerMatch® amplifier, right click the amplifier's Project View icon and choose Properties from the context menu.

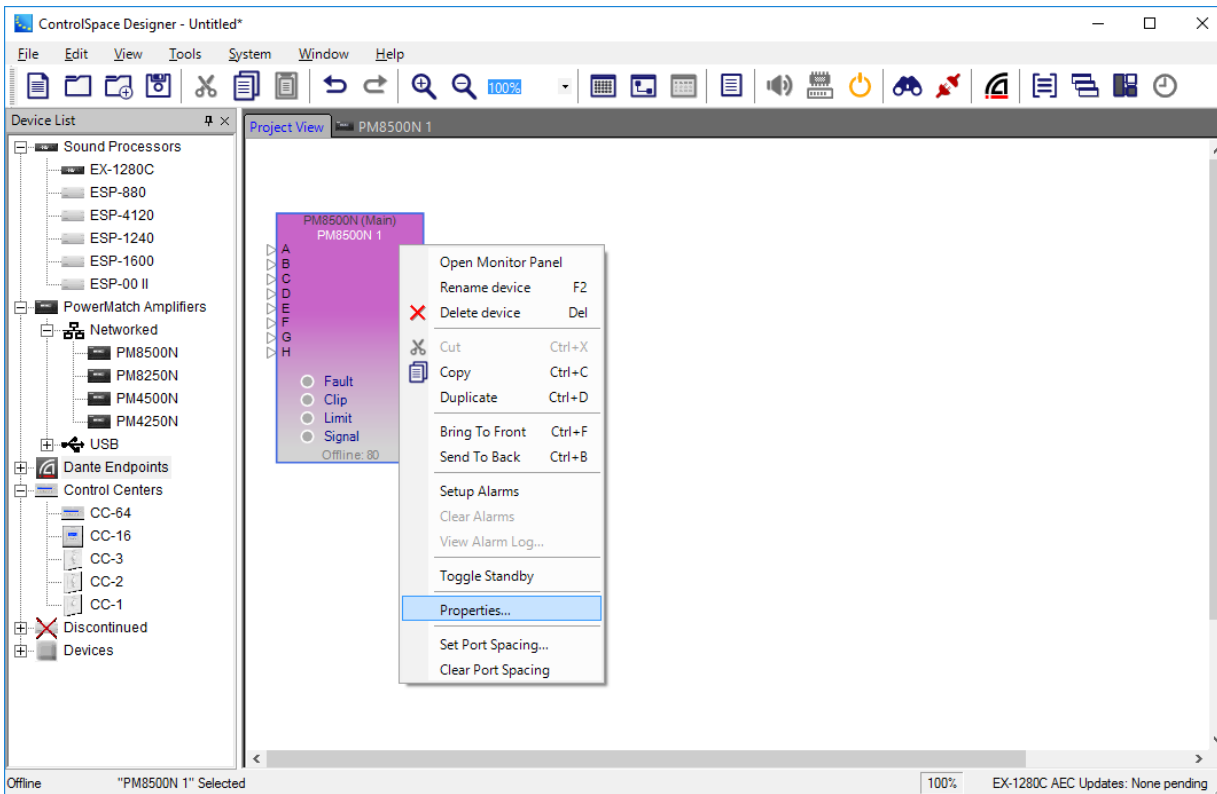

From within the PowerMatch amplifier device properties you can specify the amplifier output configuration, the digital input card type and network communication options. When selected, the Properties panel is displayed as shown:

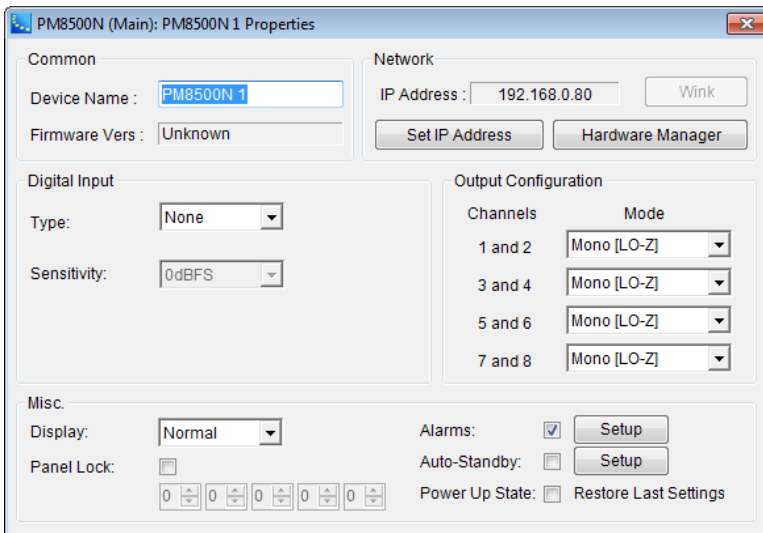

From within the Device Properties, the following options are available:

Common – Contains the properties that are common to all devices within ControlSpace® Designer™.

Device Name – This is the label used for the amplifier within ControlSpace Designer. Once a connection is established, this name is displayed on the front panel of the unit.

Firmware Vers – Displays the currently loaded firmware version of the device. "Unknown" is displayed when the device is initially dragged into the Project View. This field updates after going online.

Network – Displays the current network settings for network versions of PowerMatch amplifiers. Within the properties pane for the USB versions, this section is labeled "Device Identification" since no network options are available.

Set IP Address – Clicking this button allows you to change the IP address of the device.

Hardware Manager – Clicking this button opens the Hardware Manager dialog (see [Launching the Hardware Manager](#)).

Wink – Causes the front panel display of the unit to flash momentarily. This function is available only when the amplifier is on-line.

NOTE: All network versions of PowerMatch amplifiers are configured for DHCP operation at the time of manufacture. When an installation is performed, the network configuration should be set to fixed IP addressing. See [Setting Device IP Addresses](#) to learn how to modify the network settings for a PowerMatch amplifier.

Digital Input – Selects the type of digital card installed in the Expansion slot: None, ESPLink, CobraNet, Dante, AES3, or AmpLink. When a digital input is selected, the corresponding digital inputs/outputs are displayed on the device view of the PowerMatch amplifier.

NOTE: Device properties for PM4250/N and PM4500/N amplifiers allow selection between the upper 4 or lower 4 channels of the digital input card. This allows you to send 8 channels of audio to the amplifier, with channels 1-4 carrying separate program material from channels 5-8.

Output Configuration – Determines the output mode for each pair of amplifier outputs. See the [Output Configuration](#) section for additional details.

Misc

Display – Determines the display brightness for the front panel display of the hardware. Available settings are Normal and Dim.

Alarms – Activates alarm messaging. When selected, the PowerMatch amplifier broadcasts alarm conditions on the network. Click **Setup** to configure the alarm conditions that will trigger a notification. See [Working With Alarms](#) for instructions.

Auto Standby – Activates automatic standby. When selected, the PowerMatch amplifier will automatically place itself into standby when it no longer detects an input signal after a specified time period. Click **Setup** to configure Auto Standby (see [Working with Auto-Standby](#)).

Panel Lock – Enables the front panel lock. Use the numeric lock to specify the access code. Once the front panel is locked, you will be required to enter the passcode when connecting to the PowerMatch amplifier using either the network or USB interface.

Power Up State – The power on state describes the state of the hardware settings at the time the amplifier has power applied, or comes out of Standby. In USB models the default selection is "restore last settings", and in Network models the default is to have this selection disabled.

When **Restore Last Settings** is selected, the amplifier will save its current operating state when powering down, or entering standby. When power is restored these settings will be restored. This is the default operation for USB-only models.

When **Restore Last Settings** is deselected, the initial 'power on state' that was saved at the time the configuration was sent to the hardware using ControlSpace Designer software will be used when power is restored. This is the default operation for network models.

Output Configuration

Each pair of PowerMatch® amplifier outputs may be configured for Mono, V-Bridge, or I-Share mode to accommodate various loudspeaker loads and power levels. In addition, four amplifier channels, two pairs, may be configured for operation in Quad Mode (Current and Voltage Bridged) to deliver four times the power of a single channel.

To configure the output section of a PowerMatch amplifier:

1. **Go Offline.** The output configuration may only be changed when the PowerMatch amplifier is off-line.
2. Display the [Amplifier Properties](#). Output configuration settings are located within the amplifier properties panel.

3. Select the desired **Output Configuration**.
4. Close the **Properties** panel.
5. **Go Online**. Select the Go on-line button or choose Go on-line from the Tools Menu.
6. Select **Send to Devices** from the available options.

You will receive the output configuration confirmation dialog if the output configuration in the Project View does not match the output configuration of the hardware.

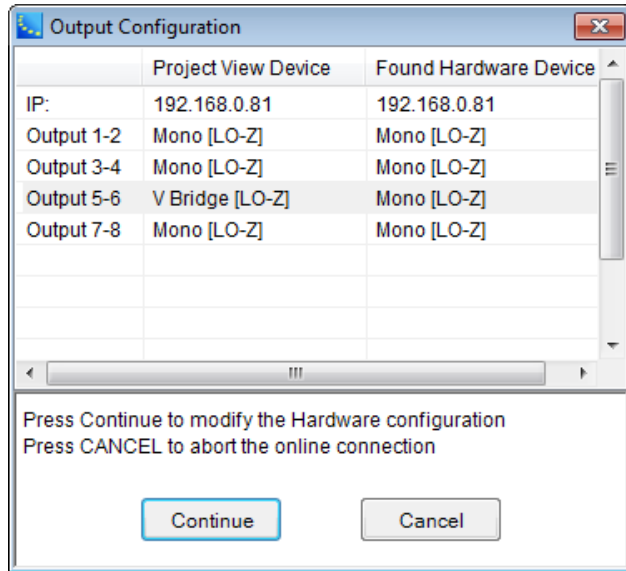

The differences in the output configuration between the Project View and the hardware are highlighted.

7. To **accept the change** in output configuration, click **Continue**.

To ignore the change and **leave the hardware untouched**, click **Cancel**.

When **Continue** is selected, the new configuration settings are sent to the hardware.

Configurations which do not require a special jumper, Mono and VBridge, are implemented immediately within the hardware once the connection is established.

Configurations which require the installation of an output wiring jumper, I-Share and Quad Mode, require the unit to be placed into standby.

At this point you are presented with a secondary dialog asking you to confirm that the output wiring is correct for the selected output configuration:

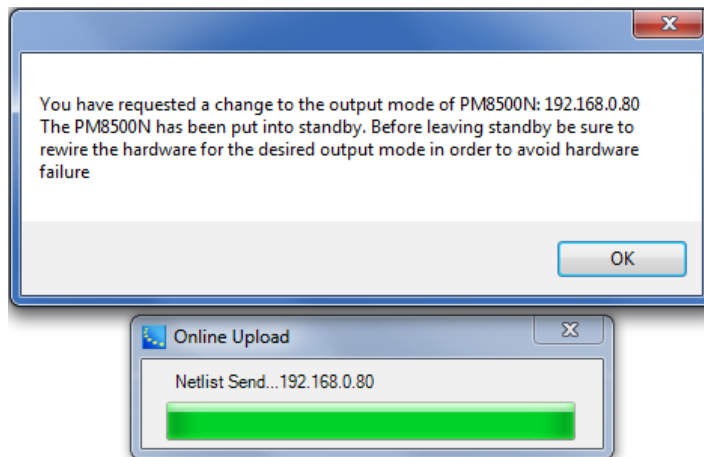

8. Select **OK** to send the new settings to the hardware, and establish a connection to the amplifier. At this point you will be on-line and connected to the amplifier, although it will be in standby.
9. From within Project View, right-click on the amplifier's icon and select **Toggle Standby** to place the unit into operation.

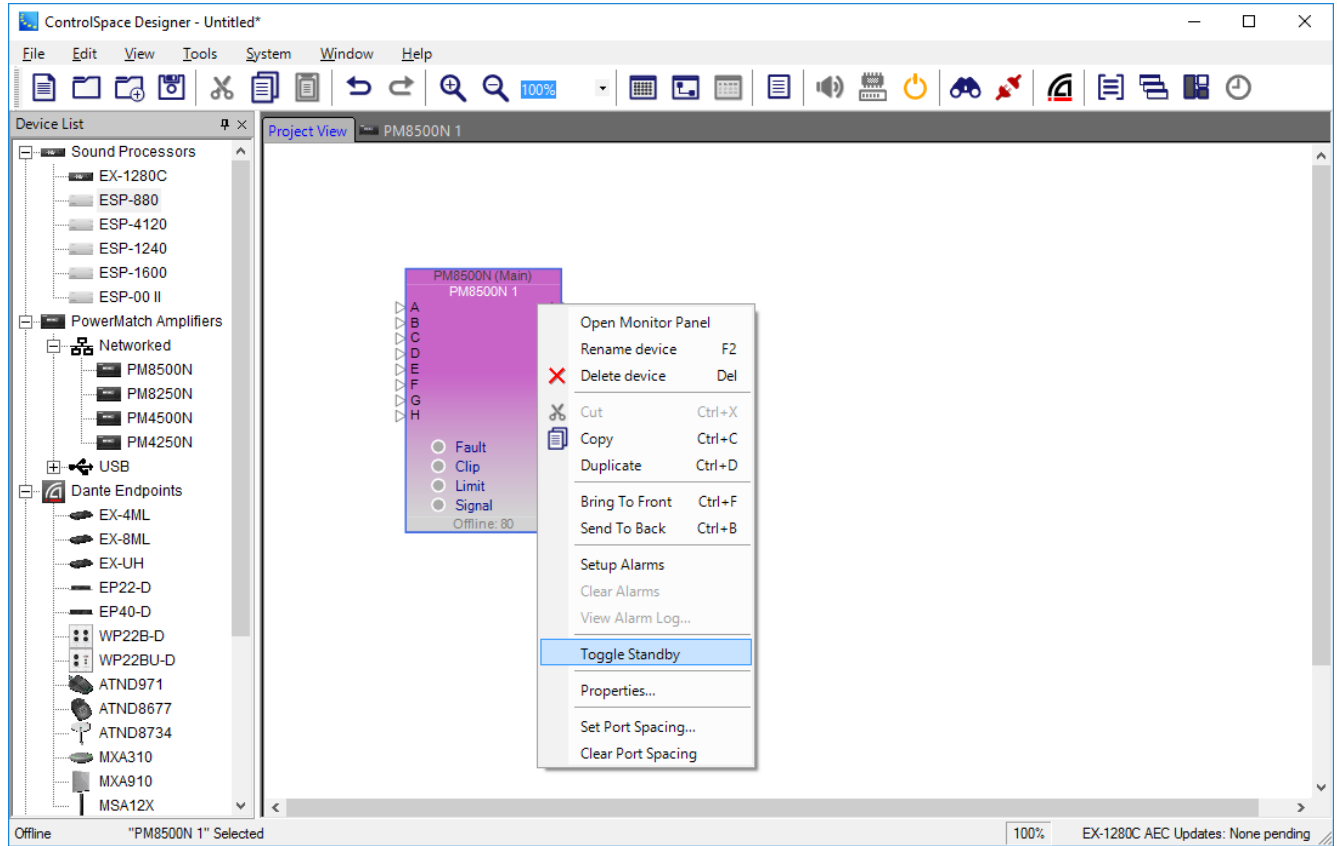

10. The Project View and Signal Processing View for the PowerMatch amplifier reflect its current output configuration. You can use these displays to determine the currently active output configuration for the amplifier.

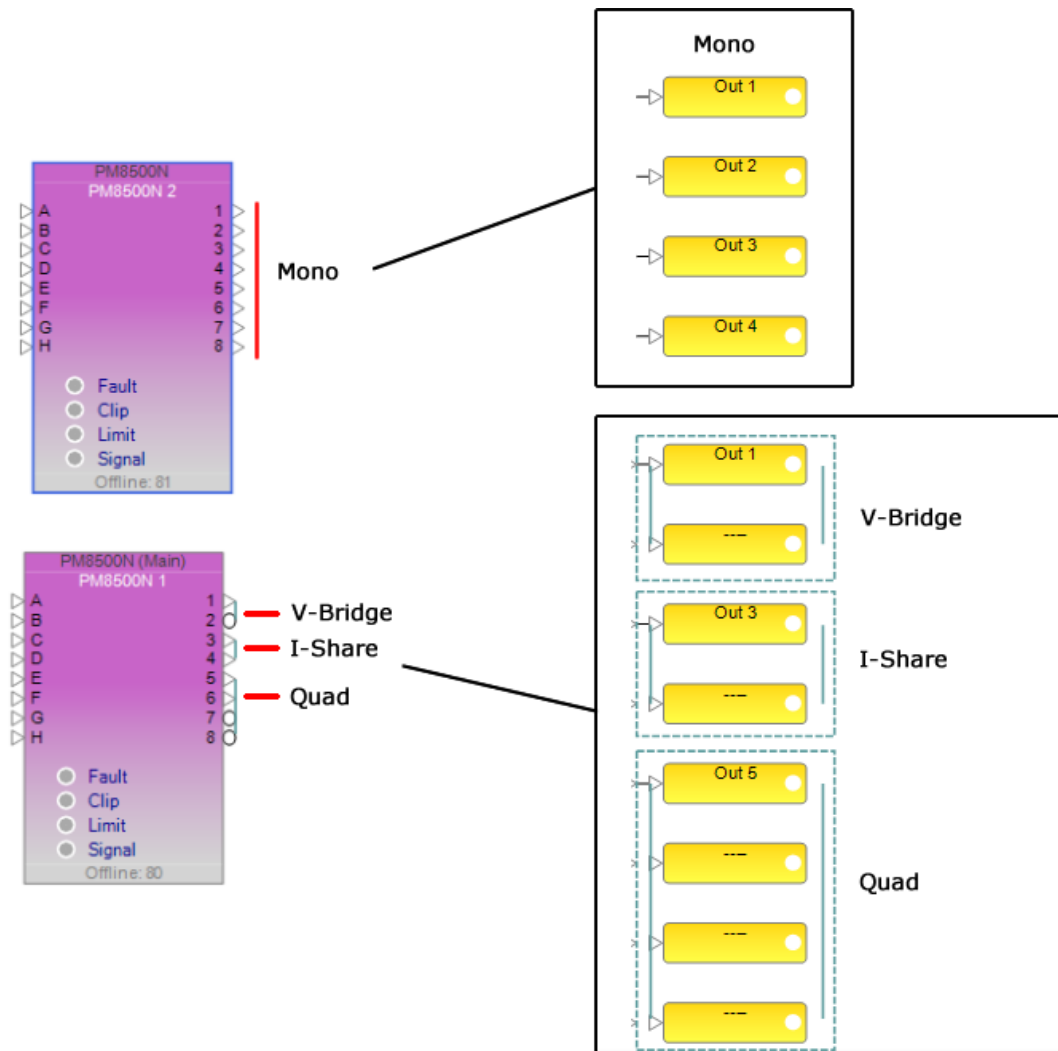

USB Connection

The USB control of a device from within ControlSpace® Designer™ software offers an enhanced level of device control as compared to what is available from the front panel. Some devices, like the PowerMatch amplifiers, are available but do not support Parameter Set and Group control of individual processing blocks.

The USB connection may be used to configure processing parameters within the amplifier, monitor operation in real time, or to quickly service and replace an existing system.

NOTE: ControlSpace Designer software does not support simultaneous USB connections. Only a single device may be controlled via a point to point USB at one time; multiple devices connected to the PC via a USB hub is not supported.

Initial USB Connection

When launching ControlSpace Designer software (or plugging in a PowerMatch amplifier while ControlSpace Designer is running) you will be prompted to establish a connection with the hardware.

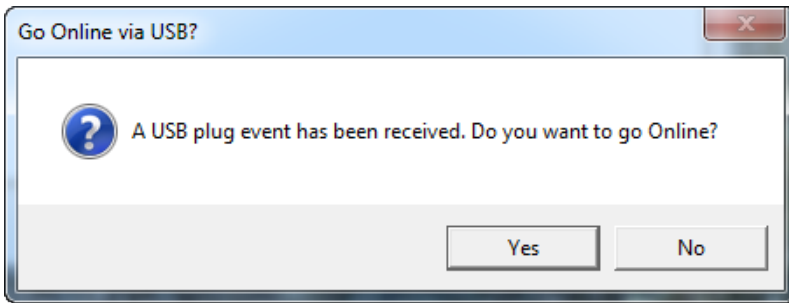

USB Connection Dialog

As the connection is established you will need to determine how you wish to connect to the hardware. Available options are to retrieve the hardware settings and display them within ControlSpace Designer, replace the current hardware settings with those in ControlSpace Designer software, or to cancel.

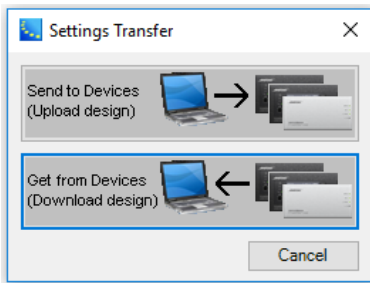

Settings Transfer Dialog

Once the USB connection has been established between the PC and hardware, the PowerMatch amplifier is displayed within the Project View. An active USB device connection is indicated by green background in both the Project and Signal Processing Views.

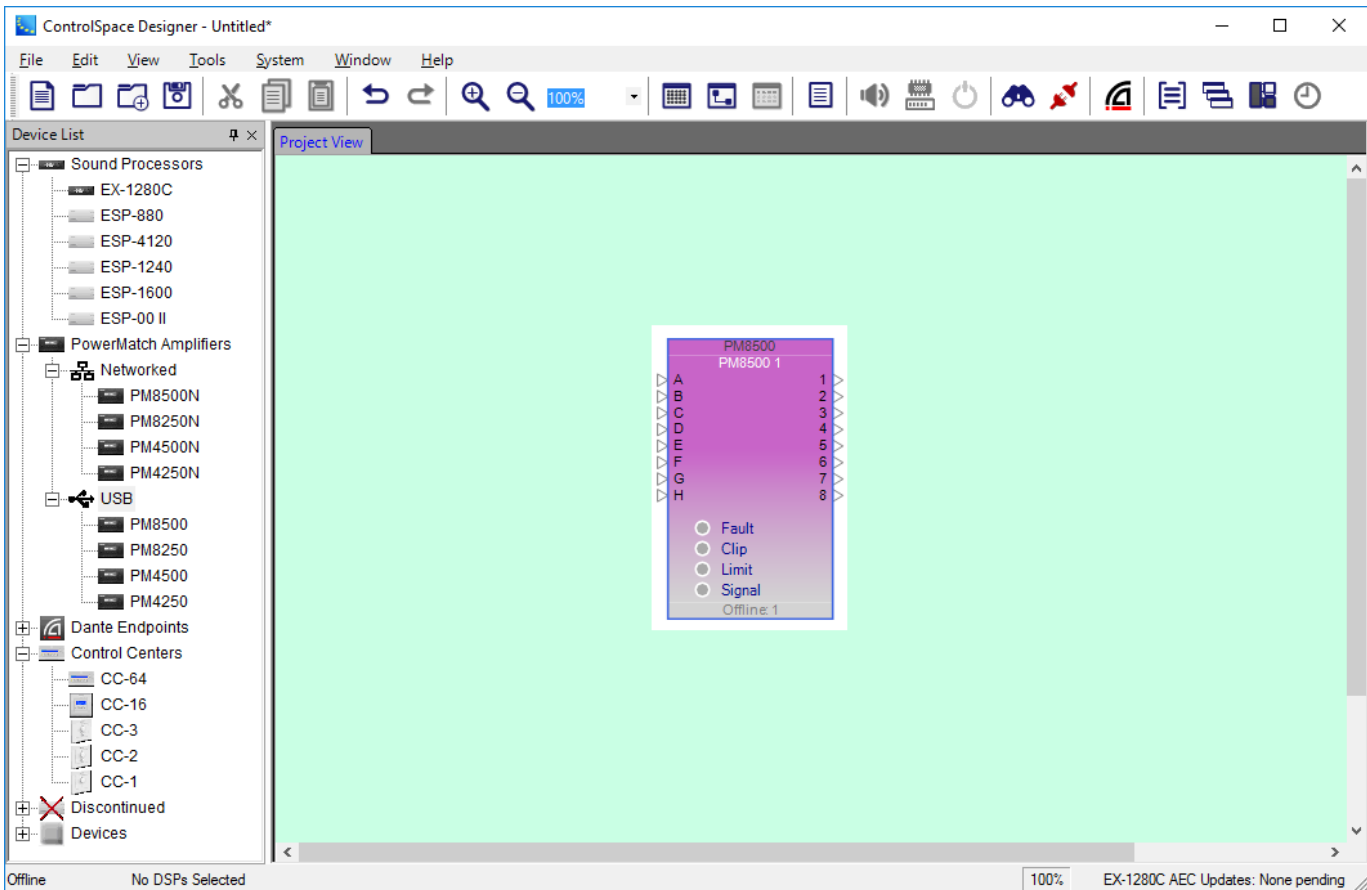

USB Device Numbering

Each USB device within a ControlSpace project uses a unique Device ID. The first USB device uses an ID of 1, and as devices are added to the project view the device IDs are automatically incremented.

Each USB device ships with a Device ID of 1 from the factory. When multiple USB devices are used within a single project you will need to manage the device addresses carefully to avoid applying the incorrect settings to the hardware.

Once a device connection is established between a device and ControlSpace Designer software the association is stored with the Project File. This relationship is maintained for subsequent connections.

Adding a Device to the Project via USB

When connecting to a device via USB, ControlSpace Designer software determines if the new device exists within the project. If the device does not exist within the Project it will be automatically added to the Project View and a connection will be established.

If, however, a USB device of this type is already present within the Project View, and the Device IDs match you will be asked to determine how you would like to manage the hardware configuration and settings.

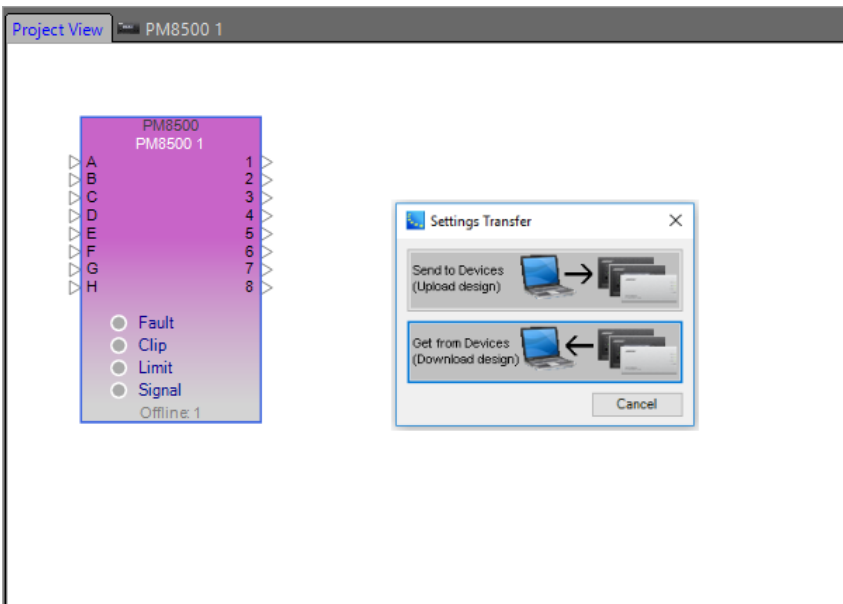

Settings Transfer:

Send To Device – Applies the current configuration and processing settings of the Project View device to the hardware.

Get From Device – Applies the current configuration and processor settings of the hardware to the Project View device.

Cancel – Stops the connection process and restores control to the ControlSpace Designer software.

In some situations the Device ID of the hardware does not match any of the Device IDs within the Project. In this case you must determine if the hardware to which you are connected is represented by one of the current devices in the Project View, or if it is a new device which must be added to the project.

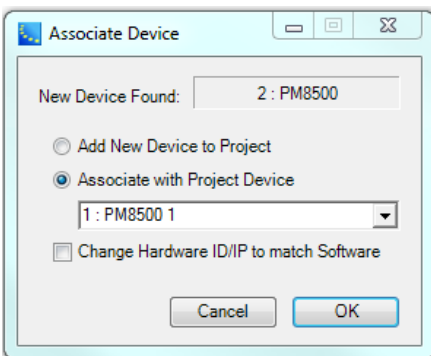

Associate Device:

Add New Device to Project - Adds the device to the Project View. Click **OK** to establish a connection.

Associate with Project Device - Activates the Device List drop-down menu. From this list, select the Project View device to associate with the hardware. Click **OK** to establish a connection. Any hardware reconciliation dialogs will appear as necessary.

Change Hardware ID/IP to match Software - Changes the ID/IP of the new device to match ID/IP used in ControlSpace Designer software.

Front Panel Lock Enabled

A PowerMatch amplifier may be configured to have the front panel locked to prevent access to the system. When a USB connection is established with an amplifier in a locked state you will be prompted to enter the front panel lock combination to enable the connection.

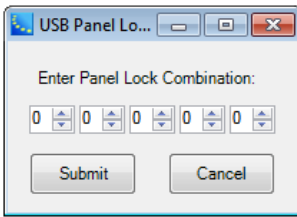

Closing a USB Connection

USB connections may be closed by either selecting the Go Offline menu item from the System Menu, or by disconnecting the USB cable between the PC and hardware.

When supports the control of devices which are configured for USB control. The first time a USB enabled hardware device is connected to the PC you will be prompted to locate and load the correct USB driver for the device. Once this step is performed all subsequent connections via USB will occur automatically.

Signal Processing

Signal Processing View

PowerMatch[®] amplifiers include an integrated loudspeaker processor to provide loudspeaker and array processing for Bose loudspeakers. A fixed block diagram architecture provides input signal processing, routing and output signal processing. The signal processing may be pre-configured and sent to the hardware upon connection, or configured while connected and the settings saved within the hardware.

To view the signal processing functions within the PowerMatch amplifier, select the amplifier's signal processing tab.

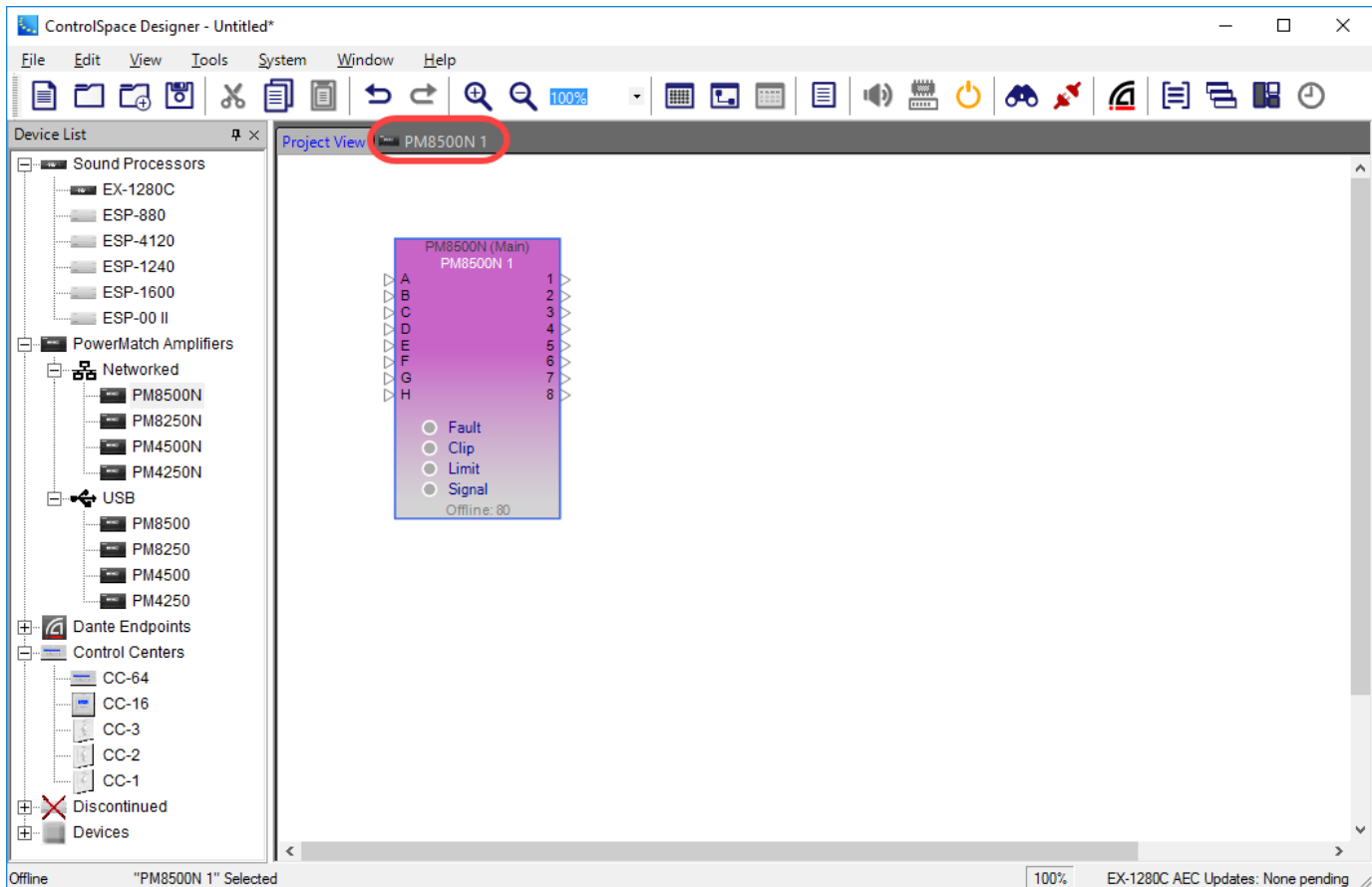

The Signal Processing View includes the full block diagram. To access any of the signal processing functions, double click on their device icon to expose their control panel.

The screenshot displays the Signal Processing View for project PM8500N 1. It features a signal flow diagram with eight input channels (In A to In H) and three output channels (Out 1 to Out 3). A red arrow highlights the PEQ-5band A block. The control panel for this block is open, showing a frequency response graph and a table of parameters.

Type	Freq (Hz)	Q	Gain (dB)	Bypass
1 PEQ	1000	1.000	0.0	Bypass
2 PEQ	1000	1.000	0.0	Bypass
3 PEQ	1000	1.000	0.0	Bypass
4 PEQ	1000	1.000	0.0	Bypass
5 PEQ	1000	1.000	0.0	Bypass

Input Control

Control of the input sensitivity for each of the eight inputs, and selection between the input source type, analog or digital, is accomplished using the input Control Panel. Within the Signal Processing View, each input is represented as a block.

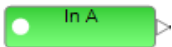

Input Label – Default label is “In *n*”, and may be modified while off-line.

Output Connection – Displays the output connection status, active or mute (red). It is not user accessible, i.e. the user cannot “wire” this output to another input.

Input Signal Level Meter – Displays the current input signal level as green, yellow, orange or red.

To access the Input Control Panel, double click on any of the eight input blocks.

The available PEQ controls and indicators for the Input Control Panel are described below:

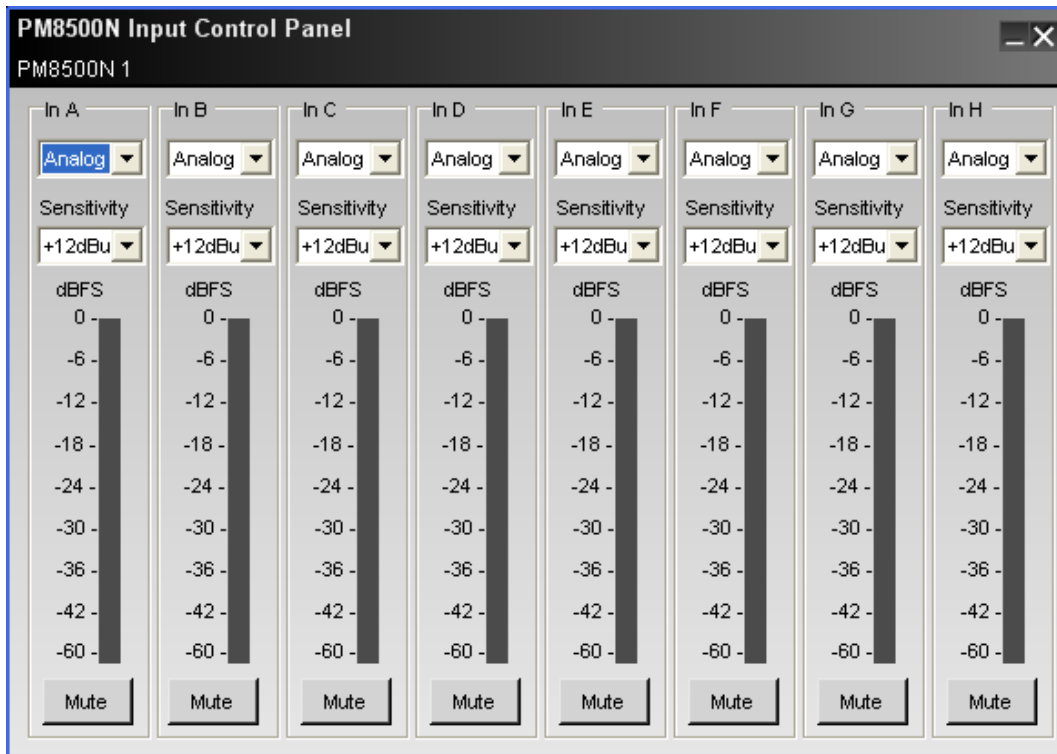

Image representative of 8-channel amplifiers. Four channel models have 4 input controls.

Input Channel Label – Reflects the label applied in the Signal Processing View. The default channel label is "In *n*."

Input Source Select – Selects the desired input source – analog or digital for each input. Digital is available for any of the Digital Type selections (ESPLink, CobraNet, Dante, AES-3, or AmpLink) in the properties panel of the device.

Input Channel Sensitivity – Selects the desired input signal level to drive the PowerMatch amplifier to its full output. This item is only available for analog inputs. Digital input sensitivity is found in the amplifier properties panel.

The analog input sensitivity you select will determine the available input headroom and dynamic range of the input channel. When selecting the input sensitivity, it is important to determine that appropriate level of noise performance for the application. See the PowerMatch amplifier *Installation Guide* for detailed information related to the Analog and Digital input sensitivity settings.

Input Channel Signal Level Meter – Displays the current input signal level and is scaled to 0 dBFS and OFF (-inf or MUTE). The meter is monitoring the signal level post A/D conversion, and is monitoring the RMS signal level.

Input Channel Mute – Applies a full mute (no audio) to the selected input channel. When the input is in a mute state, the input meter is still active as a reference.

Signal Generator

A signal generator is available within the signal processing diagram for a PowerMatch amplifier to provide the functions of a tone, sweep, and noise generator. Within the Signal Processing View, each signal generator is represented as a block. By default, the signal generator is muted to prevent accidental damage to any loudspeakers connected to the amplifier outputs. The output connector displays the output connection status, active or muted (red).

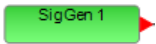

The available controls and indicators contained within the Signal Generator Control Panel are:

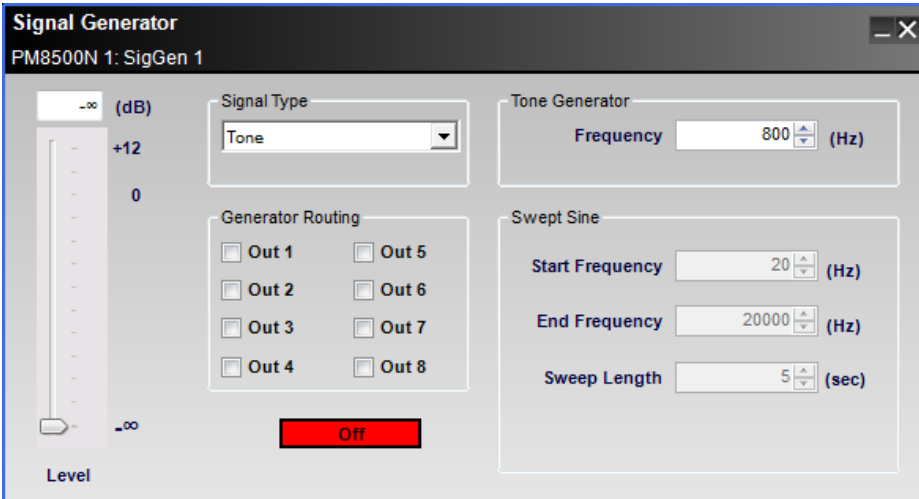

Level - Adjusts the output level from the signal generator

Signal Type - Selects the type of signal type to be generated: Pink Noise, White Noise, Tone, or Sweep.

Generator Routing - Selection for the output where the signal generator will be routed.

Generator On/Off - Activates or deactivates the noise generator.

Tone Generator Frequency - Selects the desired frequency for the tone generator in Hertz.

Swept Sine (Start Freq/End Freq/Sweep Length) - Defines the start and stop frequencies, in hertz, and the sweep length, in seconds.

NOTE: It is possible to create a reverse sweep by setting the Start Frequency higher than the End Frequency.

Input Parametric EQ

Each input signal processing chain includes an Input Parametric EQ. Within the signal processing view each Parametric EQ is represented as a block.

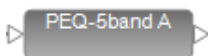

To access a Parametric EQ Control Panel, double click on its signal processing block. The available controls and indicators for the Parametric EQ Control Panel are described below:

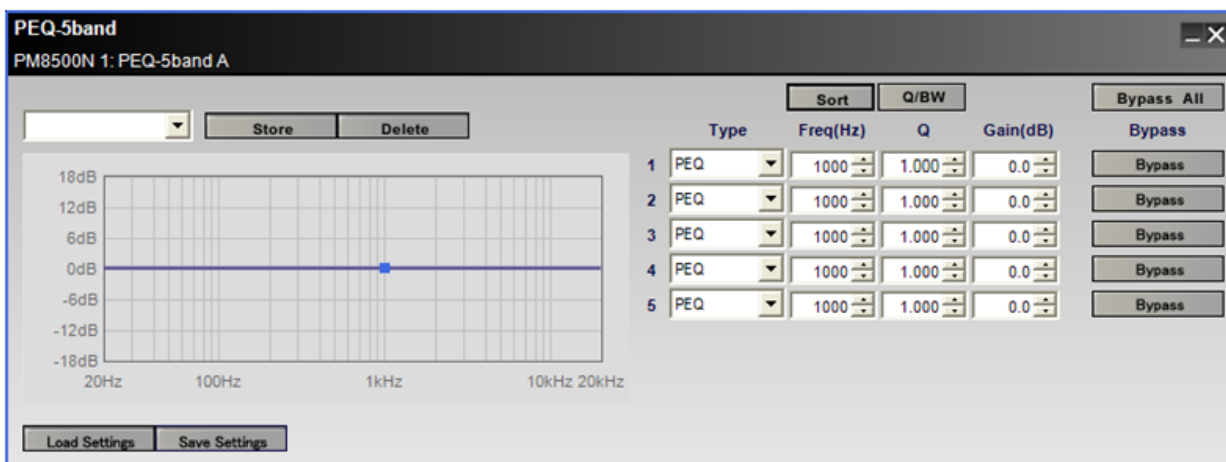

EQ Preset Select – Selects a previously stored preset and applies its settings to the PEQ, or saves the current settings as a Preset.

Name - Provides a box to enter a familiar name for the current Preset settings. When no name is entered, default system names are automatically generated. To save the current name, click the **Store** button.

Store – Commits the current settings to memory. Preset names and settings become part of the design file when saved to disk.

Delete – Removes the currently selected Preset from the drop down list but retains the Preset settings until a new preset is selected.

EQ Graph – Graphs the current PEQ settings.

Load / Save Settings – Supports the loading and saving of all current PEQ values to an external .PEQ file on the hard drive.

Filter Type – Defines the filter type for the selected filter stage. Available options are PEQ, High Shelf, Low Shelf, Notch, High Pass and Low Pass.

Frequency – Defines the frequency, in hertz, where the filter is applied.

Q – Defines the Q of the filter for PEQ and Notch filters.

Gain – Defines the amount of boost/cut applied to the PEQ stage.

Bypass – Bypasses the selected PEQ stage.

Sort – Sorts the filter stages by Frequency.

Q/BW – Switches between Q and Bandwidth.

Bypass All – Bypasses all filter stages.

Array EQ

The Array EQ signal processing function provides specialized equalization for RoomMatch[®] array module loudspeakers. This unique EQ processor may be used as a general purpose room compensation EQ for standard systems.

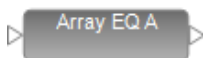

To access the Array EQ control panel, double click on its signal processing block in the Signal Processing View. The default state of the Array EQ is Bypass, to provide a flat initial response.

The following controls are available within the Array EQ:

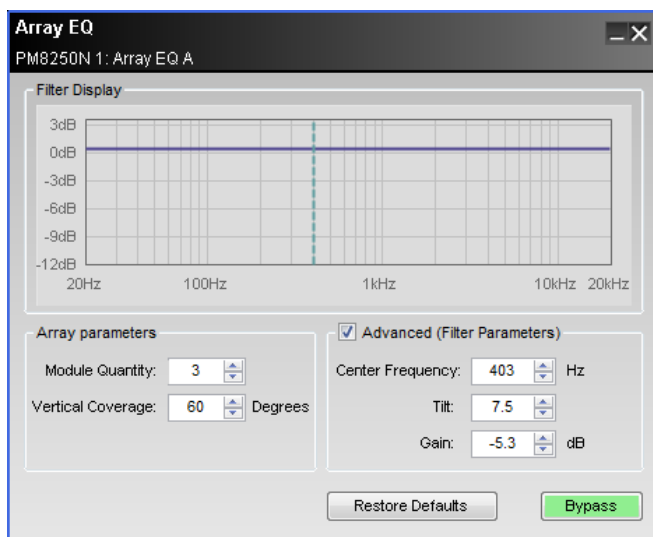

Filter Display – displays a graphical representation of array equalization settings in both frequency and level. The line represents the composite frequency response of chosen array and advanced filter parameters.

Array Parameters – specifically for use with Progressive Directivity Arrays.

Module Quantity – selects the quantity of loudspeaker modules within the array.

Vertical Coverage – enters the total vertical coverage angle, in degrees, of the array.

Advanced (Filter Parameters) – the Array EQ is represented by three basic filter controls: Center Frequency, Tilt, and Gain. Using these controls, the basic array filter may be modified.

Center Frequency – center frequency of the filter, represented by the dashed line in the Response Graph.

Tilt – adjusts the start and end points of the filter’s slope on either side of the center frequency. Tilt is adjustable between 0 and 10 in steps of 0.3, the greater the tilt the steeper the filter slope.

Gain – amount of boost or cut applied to the filter below the center frequency. Gain is adjustable in 0.3 dB steps between -12 and +2 dB.

Bypass – bypasses the array equalization (flat response).

Matrix

The Matrix processor routes any input source to one or multiple outputs, or multiple inputs may be routed to a single output. Within the matrix control panel it is possible to apply a cut-only gain to each of the matrix cross points. The output connectors display the output connection status (active or mute).

To access the matrix mixer control panel, double click on its block in the Signal Processing View.

	Out 1	Out 2	Out 3	Out 4	Out 5	Out 6	Out 7	Out 8
In A	0.0	0.0	0.0	0.0	0.0	0.0	0.0	0.0
In B	0.0	0.0	0.0	0.0	0.0	0.0	0.0	0.0
In C	0.0	0.0	0.0	0.0	0.0	0.0	0.0	0.0
In D	0.0	0.0	0.0	0.0	0.0	0.0	0.0	0.0
In E	0.0	0.0	0.0	0.0	0.0	0.0	0.0	0.0
In F	0.0	0.0	0.0	0.0	0.0	0.0	0.0	0.0
In G	0.0	0.0	0.0	0.0	0.0	0.0	0.0	0.0
In H	0.0	0.0	0.0	0.0	0.0	0.0	0.0	0.0

Signal Gen.

Input Label – The input label for each input is determined by the input label for the analog/digital input. To modify an input label for the router, modify the input label property for the input block.

Output Label – The output label for each output is determined by the output label for the output block. To modify an output label for the router, modify the output label property for the output block.

Assign – Each input is routed, by default, to its corresponding output, 1:1 routing. To route an input to an output, select the desired cross point. Multiple inputs can be routed to a single output.

Cross Point Gain – Available using a right-click selection at any cross point.

Signal Gen. – Indicates the routing of the signal generator. **NOTE:** To change the routing

of the signal generator, use the **Signal Generator** control panel.

Band Pass Crossover

The Band Pass Crossover function provides a single mono crossover for the output signal processing chain. The Band Pass Crossover supports general purpose operation with user defined settings, or provides the loudspeaker specific band pass when a Bose loudspeaker parametric EQ is active.

Within the signal processing diagram, the Band Pass Crossover is represented by a single block.

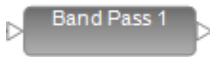

To access the Band Pass Crossover control panel, double click on the block in the signal processing view. The default state of the Band Pass Crossover is Bypass to provide a flat initial response.

The following controls are available within the crossover panel:

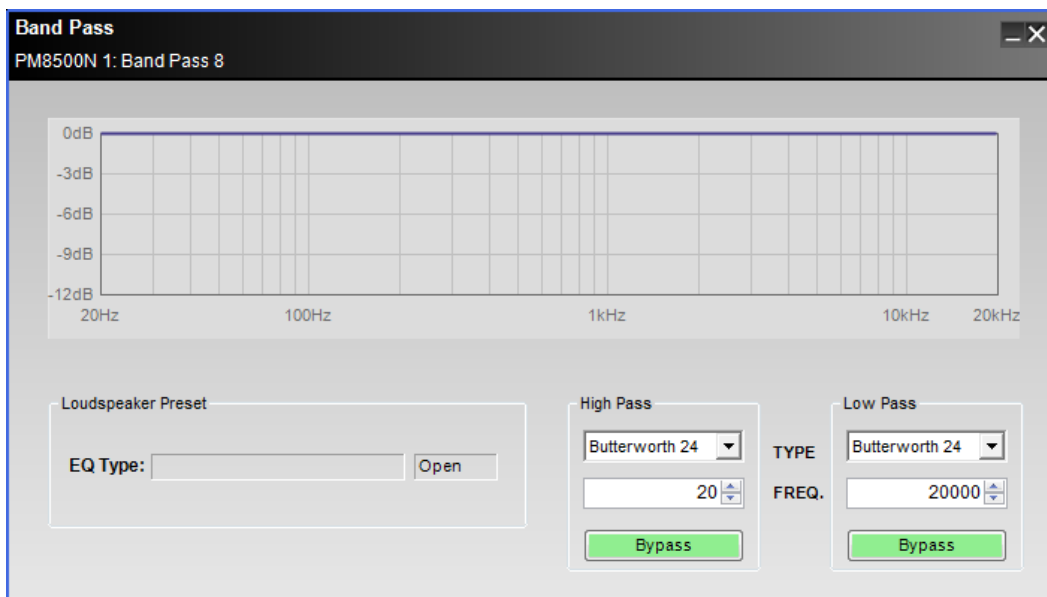

Response Graph – Displays the response curve of the High and Low Pass filter settings.

Loudspeaker Preset – When a Bose or custom loudspeaker EQ preset is loaded, the loudspeaker parametric EQ name of the active preset is displayed. Bose loudspeaker presets will cause the band pass controls to be locked. When the controls are locked, “lock” is displayed in the status section next to the EQ Type display.

High Pass Filter Type – Affects the low frequency cut off of the crossover. Available filter types are Butterworth (1st, 2nd, 3rd, 4th, 6th and 8th order), Bessel (2nd, 3rd, 4th, 6th and 8th order), and Linkwitz-Riley (2nd, 4th, 6th and 8th order).

High Pass Frequency – Defines the corner frequency of the filter.

High Pass Bypass – When active the high pass filter is bypassed.

Low Pass Filter Type – Affects the high frequency cut off of the crossover. Available filter types are Butterworth (1st, 2nd, 3rd, 4th, 6th and 8th order), Bessel (2nd, 3rd, 4th, 6th and 8th order), and Linkwitz-Riley (2nd, 4th, 6th and 8th order).

Low Pass Frequency – Defines the corner frequency of the filter.

Low Pass Bypass – When active the low pass filter is bypassed.

Loudspeaker Parametric EQ

The Loudspeaker Parametric EQ is a signal processing block which provides either a general purpose 9-band parametric EQ, or a Bose loudspeaker equalization curve. When a Bose loudspeaker equalization curve is active additional settings are applied to the Band Pass Crossover, Delay and Limiter signal processing blocks, and the settings are locked to prevent modification.

A custom set of loudspeaker settings (Band Pass, Parametric EQ, Delay and Limiting) may be saved as a preset for future use, or a Bose loudspeaker preset may be saved as a starting point for further customization.

Within the signal processing diagram the Loudspeaker Parametric EQ is represented by a single block.

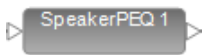

To access the Loudspeaker Parametric EQ control panel, double click on the block in the signal processing view. The Loudspeaker Parametric EQ provides 9 bands of parametric EQ, and provides access to the Band Pass Crossover settings as a convenience.

The following controls are available within the Loudspeaker PEQ panel:

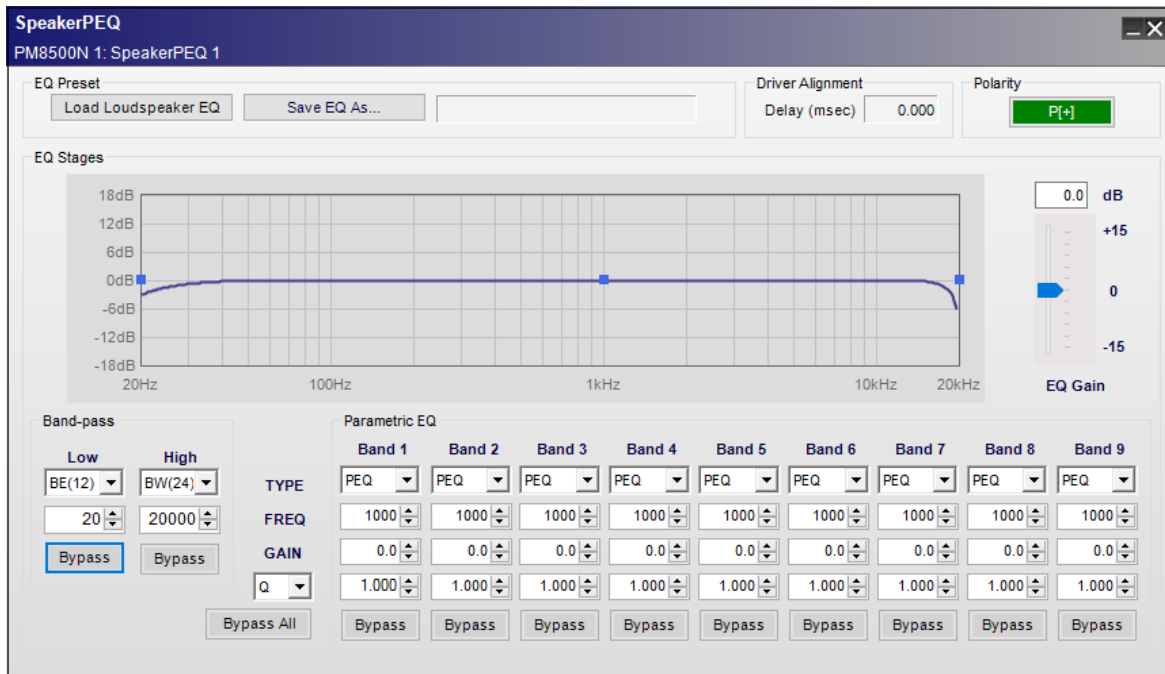

Load Loudspeaker EQ – Displays a “file open” dialog with the Bose loudspeaker EQ directory as the default setting. From within this directory, locate and open the desired loudspeaker preset file.

Once a Bose loudspeaker EQ is loaded into the Loudspeaker PEQ, the settings for the Band Pass Crossover, Parametric EQ stages, Delay and Limiter are disabled to prevent modification, and the name of the loudspeaker EQ preset is displayed.

EQ Type – Displays the name of the loudspeaker EQ which is loaded.

Save EQ As... – Saves the loudspeaker settings (parametric stages, band pass filter settings, limiter settings and alignment delay setting) as a custom file for use in another channel of signal processing or design. The default location for the Save As... function is My Documents.

Driver Alignment – Displays the amount of driver alignment delay used. This is a read-only parameter for Bose loudspeaker EQs.

EQ Graph Display – Illustrates the current response curve that is implemented. Nine grab handles, one for each band, are available and the user may directly adjust the frequency and gain for each band. Note that the graph includes the response of the band-pass filter settings.

EQ Gain - Makeup gain applied post EQ. Up to +/- 15 dB of gain may be applied.

Band-Pass Filters - This section mirrors the controls within the **Band Pass Crossover** block. Changes made here are reflected in the Band Pass Crossover and vice versa.

Bypass All - Bypasses all PEQ bands and band pass filters.

Parametric EQ Bands - Nine bands of parametric EQ are available. Each band contains the following functions:

TYPE - Filter Type: PEQ, High Shelf, Low Shelf or Notch

FREQ - Center frequency of filter in hertz.

GAIN - Gain of filter in 0.5 dB steps between +20 dB and -20 dB.

BW (Octave)/Q - Selects between 0.14 and 6.67 Octaves in .01 Octave steps (filter Q between 0.1 and 10). A user selection is available to change the display and data entry between BW (Octave) and Q.

Bypass - Bypasses the selected EQ band.

Signal Polarity Control - Inverts the polarity of the signal. Default value is positive (+) or non-inverted. When selected, the signal polarity is negative (-) or inverted. Button color is used to indicate current state with GREEN = non-inverted and RED = inverted.

Limiter

A Limiter provides both peak and RMS voltage limiting for loudspeaker driver protection.

NOTE: The limiter block is shown in the processing diagram before the output gain stage, but functionally, the output gain is pre-limiter to provide proper operation.

The limiter may be used as a general purpose peak and RMS limiter. In this application, the peak voltage should be set to prevent over-excursion of the driver, and the RMS limiter should be set to the power handling of the driver; both the peak and RMS values are entered in Volts.

When a Bose loudspeaker preset is active, the Limiter settings are specific to the Bose loudspeaker, and the settings are visible but may not be adjusted.

Within the signal processing diagram the Limiter is represented by a single block.

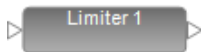

To access the Limiter control panel, double click on the block in Signal Processing View. The Limiter provides Peak and RMS limiting, a linking function, and metering of the Peak and RMS limiting, as well as the channel output level.

The following controls are available within the Limiter control panel:

EQ Type– Displays the currently selected loudspeaker equalization curve within the Loudspeaker EQ processing block.

Peak Voltage Limiting – The Peak Voltage Threshold defines the behavior of the Peak Voltage limiter and corresponds to the maximum voltage which may be applied to the driver without causing over-excursion. The read-only attack and release times are shown.

RMS Voltage Limiting – The RMS limiter behavior is defined by the RMS Voltage settings: Threshold(V), Attack (msec) and Release (msec).

Link Group – The limiter may be assigned to one of four link groups, or may act independently (no assignment). When channels are linked the presence of limiting on any of the linked channels engages the limiter on all linked channels.

When Limiters are linked, their signal processing block displays the Limiter Link Group assignment as shown:

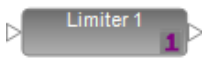

Metering – Meters display the amount of gain reduction, in dB, for both the Peak and RMS limiters. A third meter displays the total gain reduction (the greater of either Peak or RMS), in dB, being applied to the signal. An output gain meter is included to assist in the set up and configuration of the limiter.

Signal Delay

A signal alignment delay is provided to accommodate cluster or zone signal alignment. A secondary delay is indicated for Bose loudspeaker signal processing which may not be modified.

Within the signal processing diagram the Delay is represented by a single block.

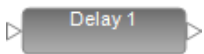

To access the Delay control panel, double click on the block in Signal Processing View. The Delay provides up to 2 seconds of signal delay per output channel. The following controls are available within the Delay panel:

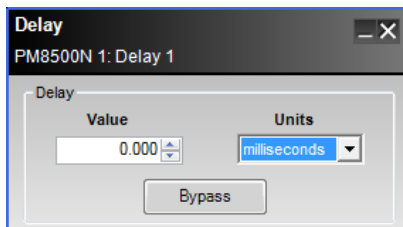

Value – Amount of signal delay applied based on the selection within the Units drop down list.

Units – The method used to determine the amount of signal delay. Available selections are: milliseconds, sample, meter, millimeter, feet, and inch.

Bypass - Bypasses any signal delay setting.

Output Attenuation

The Output Attenuation block provides control over the amplifier output for the PowerMatch amplifier. Control of the output attenuation is available for each of the eight outputs, based upon the current output configuration, and is accomplished using the output Control Panel. Within Signal Processing View each output is represented as a block.

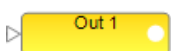

Output Label – Default label is “Out *n*”, and may be modified while off-line.

Output Connection – Displays the output connection status, active or mute (red). It is not user accessible (i.e. the user cannot “wire” this output to another input).

Output Signal Level Meter – Displays the current output signal level as green, yellow, orange or red.

Output Configuration – The current output configuration is displayed as either individual/mono, Voltage Bridge, Current Share or Quad Bridge. Outputs are configured in the Properties dialog for the PowerMatch amplifier.

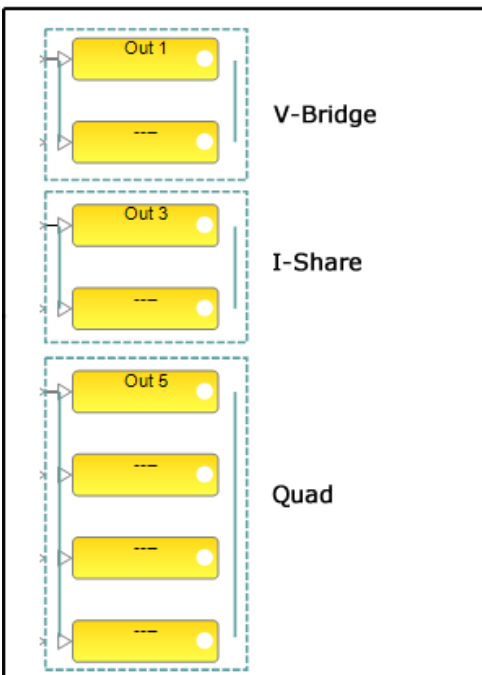
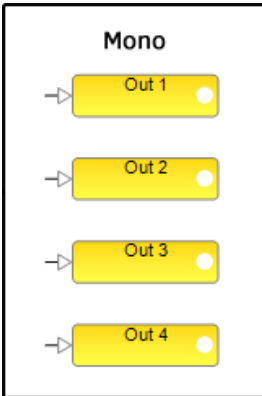

To access the Output Attenuation control panel, double click on any of the Output blocks in the signal processing view. Each of the output channels is available on the Output Attenuation control panel.

The following functions are included for each output control:

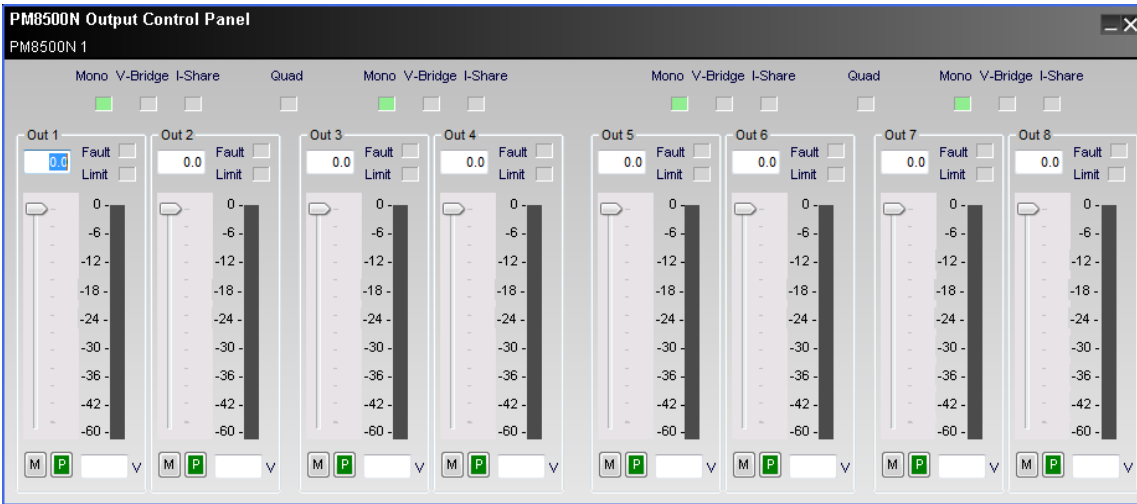

Output Mode Indicators – Displays the current output configuration for each channel pair. The following are the valid configurations:

Mono - Configured for independent channel operation

V-Bridge - Configured for voltage bridging operation, 2x voltage output. This configuration may drive a low impedance, 4 or 8 Ohm, or high impedance, 70 or 100V.

I-Share - Configured for current sharing operation, 2x output current. This configuration may drive a low impedance, 2 or 4 Ohm, only.

Quad - Configured to use four channels simultaneously to provide 4x the output voltage. This configuration may drive a low impedance, 4 or 8 Ohm, or high impedance, 70 or 100V.

When configured for Quad bridge, the two channel pairs are both configured for current sharing operation, and the Quad Bridge indicator is present as shown:

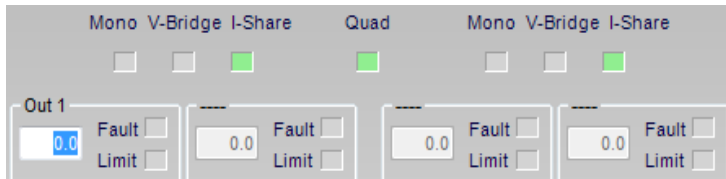

Output Channel Label – Default channel label is “Out *n*” and can be modified when offline. Channels used for V-Bridge or QuadBridge operation are shown with a “---”.

Fault Indicator – Indicates the present of a fault condition within the amplifier channel. Clicking on the Fault indicator displays the Alarm Panel. From here, details about the fault condition can be viewed, and the fault may be cleared.

Output Protection Limit Active Indicator – Illuminates yellow when any of the following amplifier protection mechanisms are engaged: Peak or RMS Voltage limiter active, gain reduction due to amplifier temperature, gain reduction due to power supply temperature.

Output Channel Attenuation – Displays the output attenuation between 0 dB (full gain) and -infinity dB. This is a user-accessible display where the user may enter a numeric value using a -00.0 format.

Output Channel Attenuation Slider – Attenuates the output gain between 0 dB (full gain) and -infinity dB.

Output Channel Signal Level Meter – Displays the current output signal level and is scaled to 0 dB (full gain) and -80.

Output Channel Mute – When active, mutes the output of the selected channel.

Output Channel Signal Polarity – When active, reverses the signal polarity.

Output Voltage Display – Displays the current output voltage of the amplifier channel.

PowerMatch Monitor Panels

Two types of monitor panels are available for the PowerMatch amplifiers:

- A full size monitor panel which displays the status of inputs, outputs and faults, as well as provides the ability to put the unit into standby
- A small amplifier status panel which is displayed when the system status function is enabled

To access a PowerMatch amplifier's monitor panel, select **Open Monitor Panel** from the right click menu of the PowerMatch amplifier within the Project View.

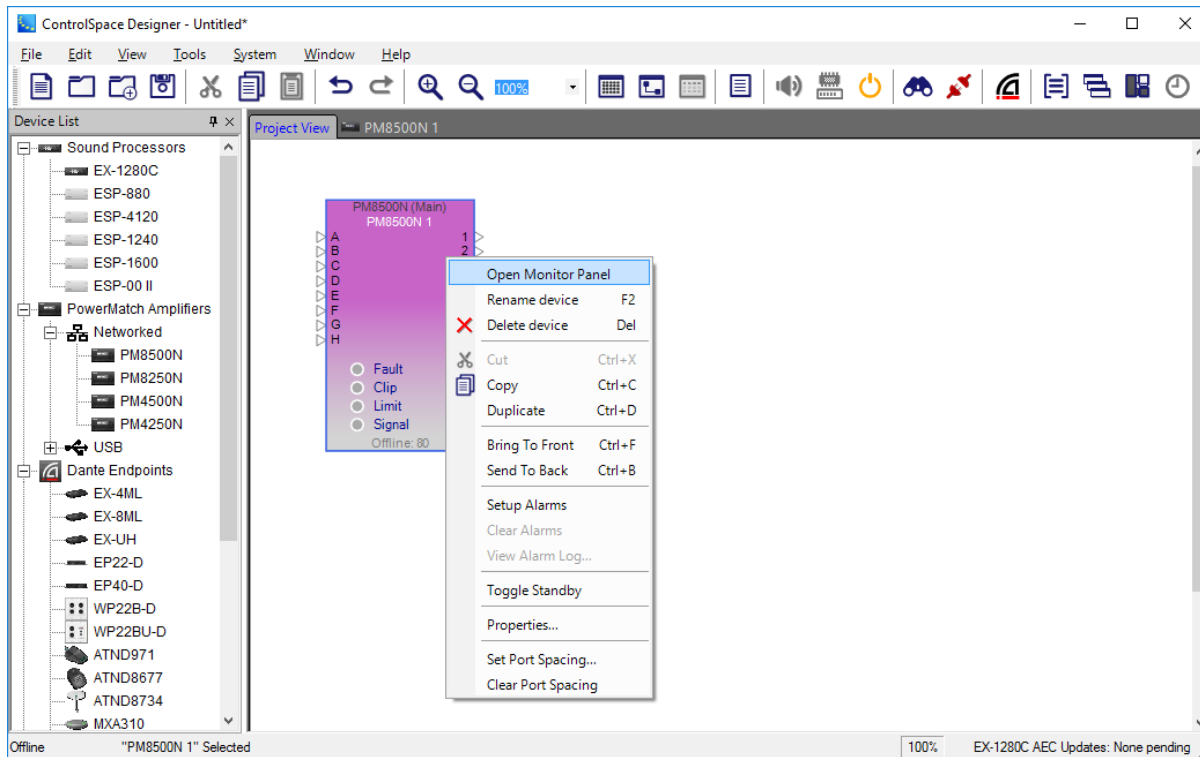

The full size PowerMatch monitor panel provides an overview of the current operational status of the device, and a control to place the amplifier into/out of standby.

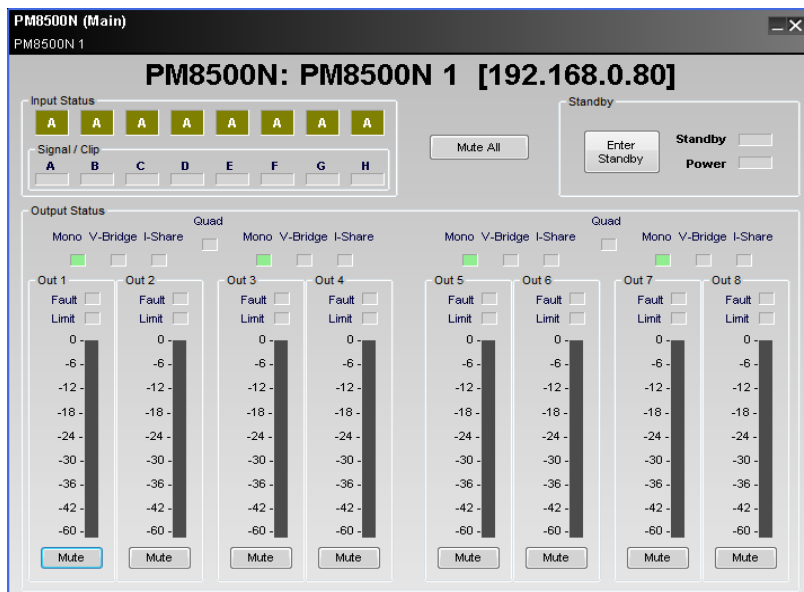

From within the PowerMatch amplifier's monitor view, the following functions are available:

Input Status - Displays the currently active input source (Analog/Digital), the Input Card type, and the input signal level for each of the eight inputs (A to H).

Mute All - Mutes all output channels.

Enter Standby - Toggles the standby state of the amplifier.

Output Status - Displays the output status for each output of the amplifier. Included indicators are the output label, channel configuration, channel alarm status, limiting/protect status, the current output signal level, and an output mute.

When the System Status Settings (**AutoTile Layout** and **Collapsed View**) are enabled in the **View** menu, the amplifier status panels for all PowerMatch amplifiers are displayed according to the selected settings.

To access the System Status function, select the system status icon  while on-line and connected to the system.

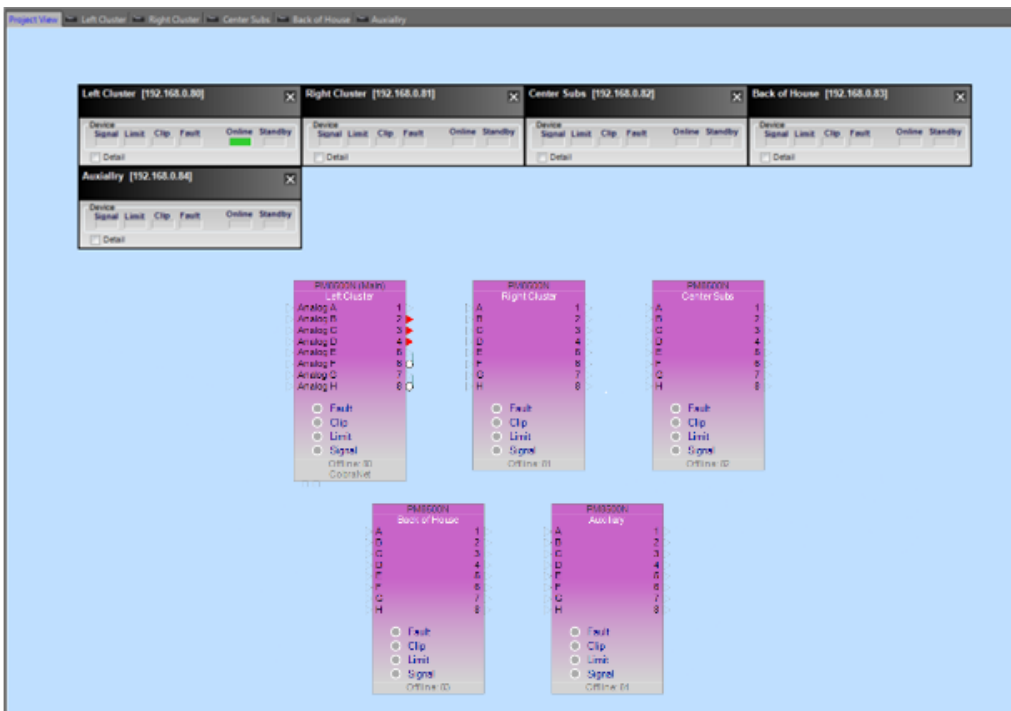

Each amplifier status panel is displayed using either a collapsed or expanded view. In the collapsed view only the primary status indicators are available.

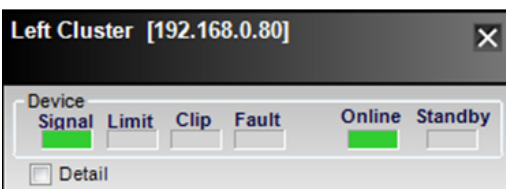

Select Detail to expand the amplifier status panel to see all of the amplifier's status indicators.

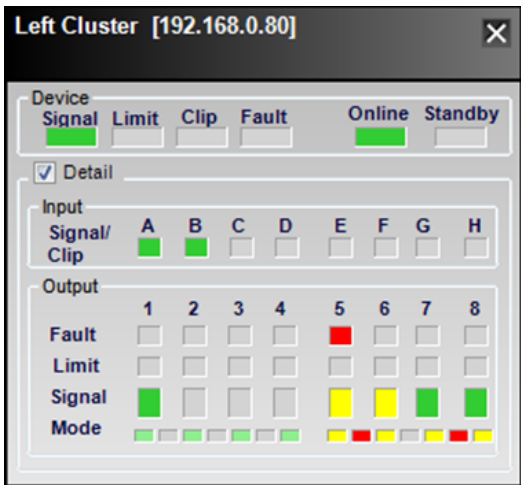

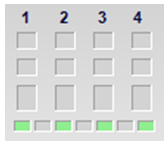
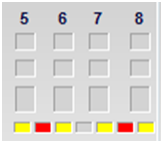
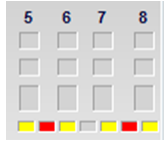
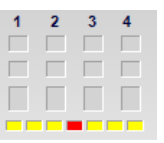
Indicator	Status
Signal	Green when input signal level is present on any input channel.
Limit	Yellow, when any output limiter is active.
Clip	Red when input clipping is present.
Fault	Red when an alarm condition is active. See the alarm properties within the device properties to configure which alarms conditions will activate this indicator.
Online	Green when device is online.
Standby	Green when device is in standby.
Input Signal Level (channel)	Green, Yellow, Red based on input signal level.
Output Fault (channel)	Red when an alarm condition exists. Click on the Fault indicator to view the amplifier alarm panel. Note this displays all alarms, regardless of the settings within the device properties.
Output Limit (channel)	Orange when output limiter is active.
Output Signal (channel)	Green, Yellow, Red based on output signal level.
Output Mode (channel)	Each of the four operation modes is represented using the mode indicators as follows: <div style="display: flex; justify-content: space-around; align-items: flex-start; margin-top: 10px;"> <div style="text-align: center;">  <p>Mono</p> </div> <div style="text-align: center;">  <p>V-Bridge</p> </div> <div style="text-align: center;">  <p>I-Share</p> </div> <div style="text-align: center;">  <p>Quad</p> </div> </div>

Working With Alarms

Each PowerMatch[®] amplifier monitors its operation for proper operating temperature, power supply status, amplifier status, open and short wiring, as well as additional alarm conditions. This information is stored locally in an internal log of all alarm conditions, and information from the alarm log may be viewed using the ControlSpace[®] Designer™ software.

In systems where the ControlSpace Designer software is connected to the devices, either via USB or Ethernet, the time and date of the alarm condition is appended to the alarm.

Alarm Summary

The PowerMatch amplifiers monitor the following alarm conditions:

Category	Alarm Condition	Description
Gain Reduction, Signal Limiting	Limiter Active due to high output current	Protection limiter engaged for any output channel.
Output Fault	Open Circuit	An open circuit, output impedance is greater than 20 Ohms.
Output Fault	Short Circuit	A short circuit detected on an output - output impedance is less than 1 Ohm. This alarm condition is always active and may not be disabled.
Input Fault	Input Clipping	Input Signal Clipping
Input Fault	Loss of Digital Audio Source	Digital audio source expected, but digital audio source is not operational.
AC Power Fault	Loss of AC Power	

For a complete list of PowerMatch amplifier fault conditions, see the PowerMatch Installation Guide at pro.bose.com.

Fault Output Configuration

The PowerMatch amplifier includes a hardware fault output capable of driving a normally open, or normally closed contact closure, 1A, 30 VDC maximum. The fault output is intended to provide an external connection to a remote system monitor for fault notification purposes.

The fault output must be enabled for operation, and must have alarm conditions defined which will trigger its operation. This is accomplished from within the Properties Panel of the PowerMatch amplifier.

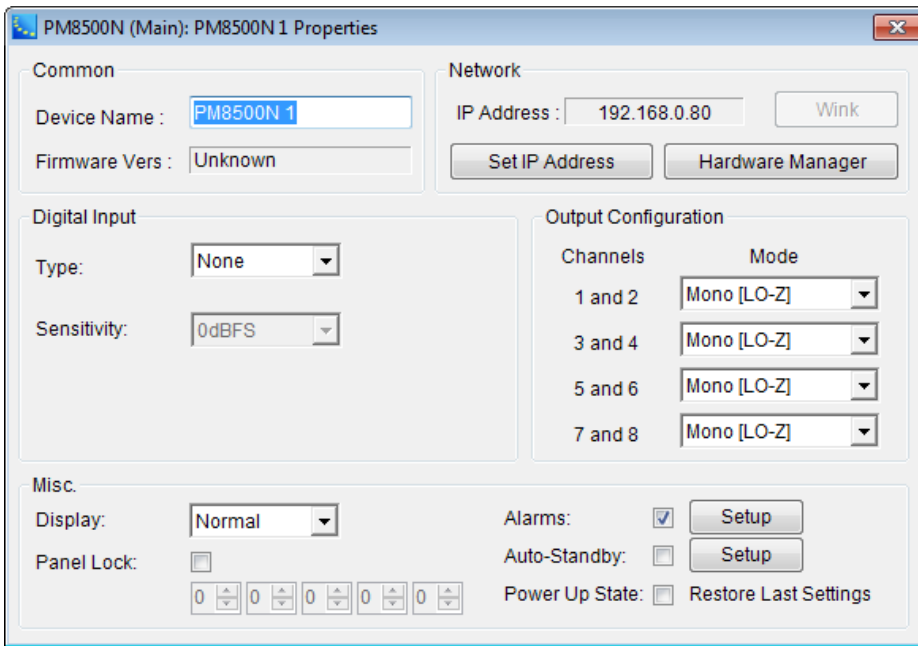

Alarms – when the Alarms check box is selected, the alarm conditions selected in the Alarm Conditions panel will trigger the fault output and front panel fault LED. Uncheck this option to disable alarms.

Alarms Setup button – click to configure which alarms will trigger the front panel LED and fault output. When selected the Alarm Conditions panel is displayed.

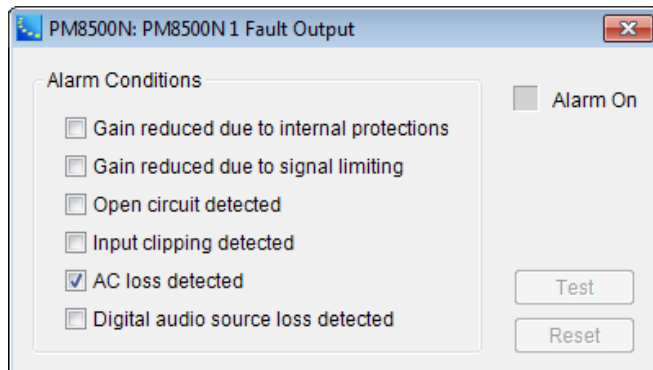

Select which alarm types will trigger the hardware Fault Output and front panel Fault LED. By default the only alarm condition selected is the AC Power Loss alarm.

Alarm Conditions – the state of an alarm condition determines how the alarm will be logged and reported via the Fault Output, front panel Fault LED, and within the ControlSpace Designer software.

Alarm ON Indicator – indicates the presence of an alarm condition.

Alarm Test – available when online with the PM8500, selecting **Test** will trigger the Fault Output and Front Panel LED.

Alarm Reset – available when online with the amplifier, selecting **Reset** will reset the Fault Output and Front Panel LED.

Viewing the Alarm Log

Upon connection to the PowerMatch amplifier, the ControlSpace Designer software automatically retrieves the alarm log from the hardware.

To access the amplifier alarm log, use one of the following options:

- Click the **Fault** indicator within the Monitor Panel for the amplifier.
- Click the **Fault** indicator within the Output Control Panel for the amplifier.

Once you have accessed the amplifier alarm log, the alarm log panel is displayed:

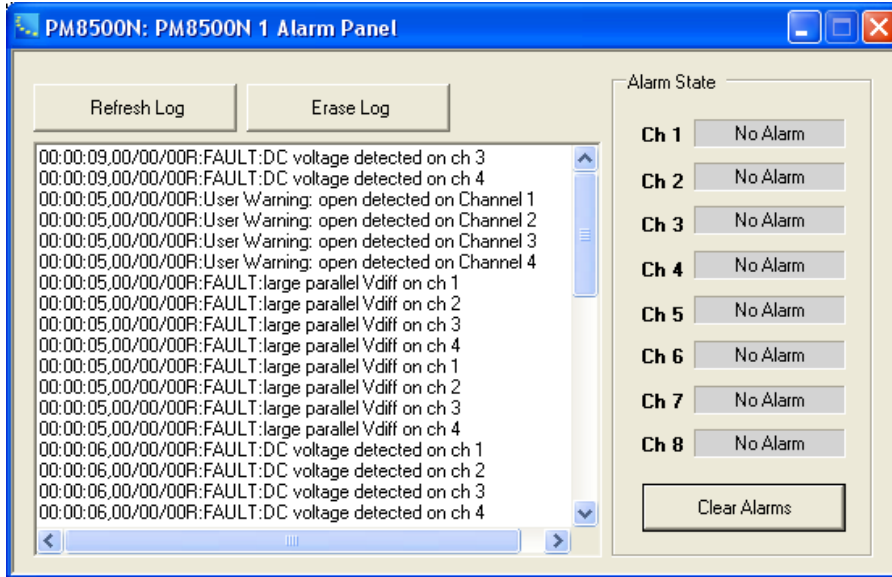

From within the Alarm Log Panel you can view, copy, erase and clear alarms. The following functions are provided:

Refresh Log – Updates the alarm list to display the most recent alarms that have occurred.

Erase Log – Clears the alarm log from both the software and hardware.

Alarm List – Displays the list of alarms which have occurred. Alarms are suffixed with either “R” or “A.” “R” indicates a relative time as recorded by the hardware, and “A” indicates the actual time the alarm occurred. Alarms suffixed with “A” occurred when ControlSpace Designer software was connected to the system.

Alarm State – Displays the current alarm state of each output channel.

Clear Alarms – Clears the alarms within the hardware. Also clears the Fault Output and front panel Fault LED.

Working with Auto-Standby

The Auto-Standby function detects the presence of an input signal on any available input channel. When Auto-Standby is active, the absence of an input signal for a specified time period causes the unit to place itself into Standby.

This function is available in all PowerMatch® amplifier models.

To set up the Auto-Standby function:

1. Select a PowerMatch amplifier in the Project View and open its Properties dialog:

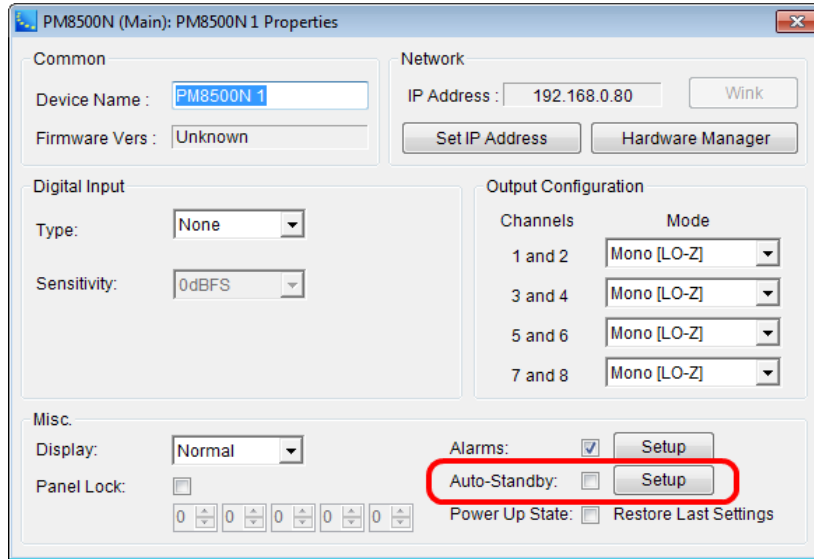

2. Select the **Auto-Standby** check box to enable the Auto-Standby function and then click the **Setup** button.

This opens the Auto-Standby configuration dialog:

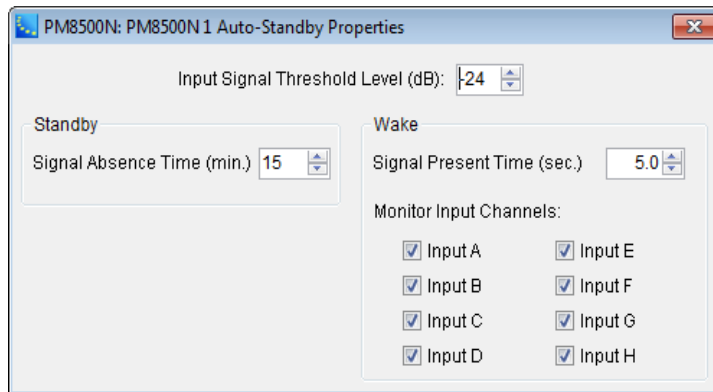

Input Signal Threshold (dB) – the level (-24 to -60 dB) below and above which the Auto-Standby timer begins counting to place the amplifier into and take the amplifier out of standby.

Signal Absence Time (minutes) – the amount of time (15 min to 12 hrs in 15-min steps) that the signal must be below the threshold before the amplifier puts itself into Standby.

Signal Present Time (sec) – the amount of time (5 to 60 sec, in 5-sec steps) that the signal must be above the threshold before the amplifier comes out of Standby.

Monitor Input Channels – allows you to choose the which input channels will be monitored for signal to bring the unit out of standby.

Measuring Loudspeaker Impedance

A load measurement function is provided to measure the load impedance of each PowerMatch amplifier output for system diagnostic and documentation purposes. The load measurement function inserts a test signal into the output signal processing chain and measures the output load impedance and current across a defined frequency range. The result of this measurement is displayed as a frequency vs. impedance graph.

The load measurement can be stored as a reference for the final system installation, and subsequent measurements may be compared to the reference to determine if the system is still operating as expected. Differences between the reference curve and a subsequent measurement can be indicative of wiring or transducer damage. The load measurement function cannot pinpoint the cause of the problem, but can indicate that a problem exists between the output of the amplifier and the transducer.

The load measurement function is accessed from within the Signal Processing View for the PowerMatch amplifier by using the right-click context menu for any of the amplifier outputs.

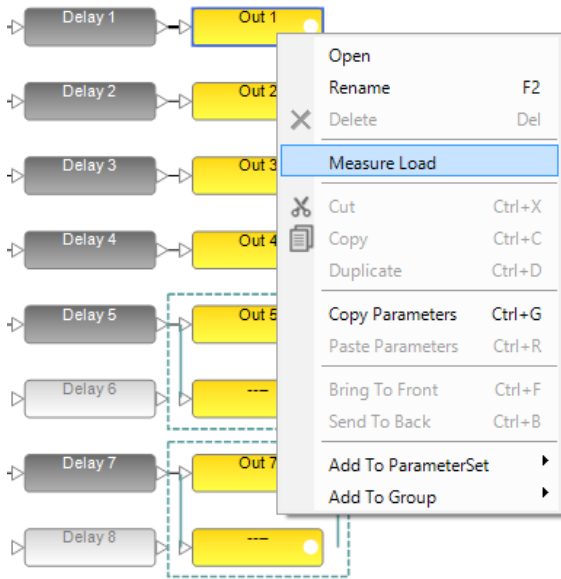

To display the Load Test Panel, select **Measure Load** from the right-click context menu :

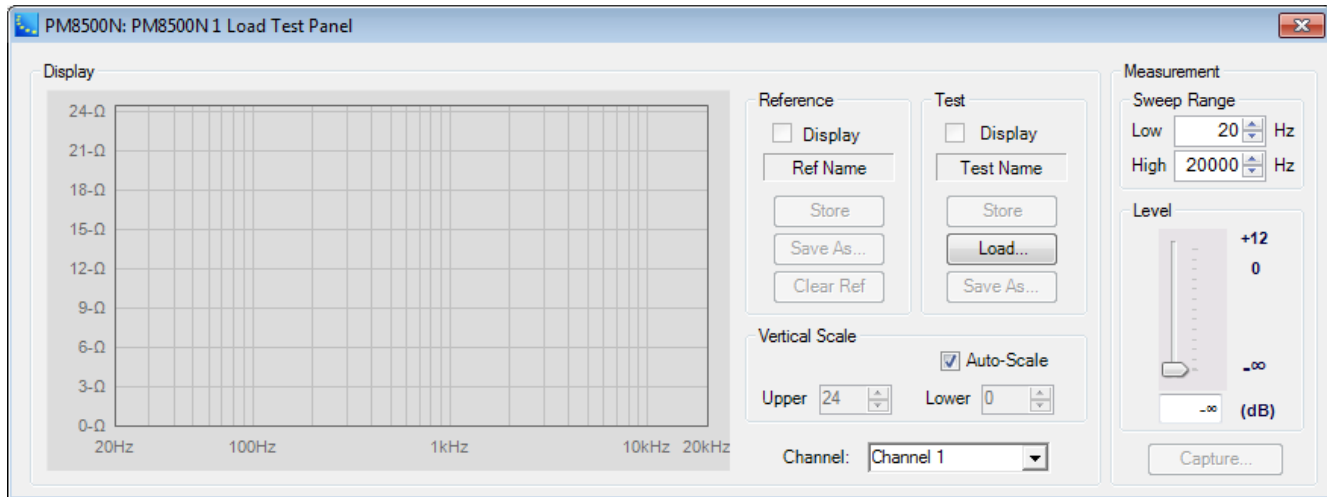

From within the Load Test Panel the following functions are available:

Impedance vs. Frequency Graph – Displays the current measurement, the reference and one additional measurement simultaneously.

Channel – Controls the output under test. The default is determined by the output block selected when the Load Measurement was invoked, but all outputs are available for selection.

Sweep Range – Determines the frequency range to be measured.

Level – Controls the output level of the signal generator. Always begin with a low output level to prevent any damage to system components.

Capture – Initiates the load measurement. The built-in signal generator is routed to the selected output and the measurement is active. Once the measurement is complete, the previous routing for the output under test is restored, and the impedance vs. frequency data is displayed.

Reference Display – Enables the display of the stored reference measurement for the selected channel.

Reference Name – Displays the user defined name of the reference measurement.

Reference Store – Stores the current measurement as the reference for this channel. When selected you have the option to name the reference curve. The reference is stored with the ControlSpace Designer file (.CSP) for future reference.

Reference Save As... – Exports the reference curve as a text file for use in other applications.

Test Display – Enables the display of the stored reference measurement for the selected channel.

Test Name – Displays the user defined name of the measurement.

Test Store – Temporarily stores the current measurement for display in the Impedance vs. Frequency graph. To save the measurement for future use select **Save**.

Test Load – Opens a previous saved measurement file for display within the Impedance vs. Frequency graph.

Test Save As... – Exports the measurement curve as a text file for use in other applications.

Vertical Scale, Auto-Scale – Automatically determines the upper and lower impedance limits and scales the graph accordingly.

Vertical Scale, Upper – Adjusts the upper limit of the Impedance scale.

Vertical Scale, Lower – Adjusts the lower limit of the Impedance scale.

Expansion Cards

ESPLink 8-Channel Input Card

The ESPLink accessory card installs into the digital input slot of the PowerMatch[®] amplifiers. It receives eight digital audio channels from a ControlSpace[®] ESPLink output card. An optical cable is included.

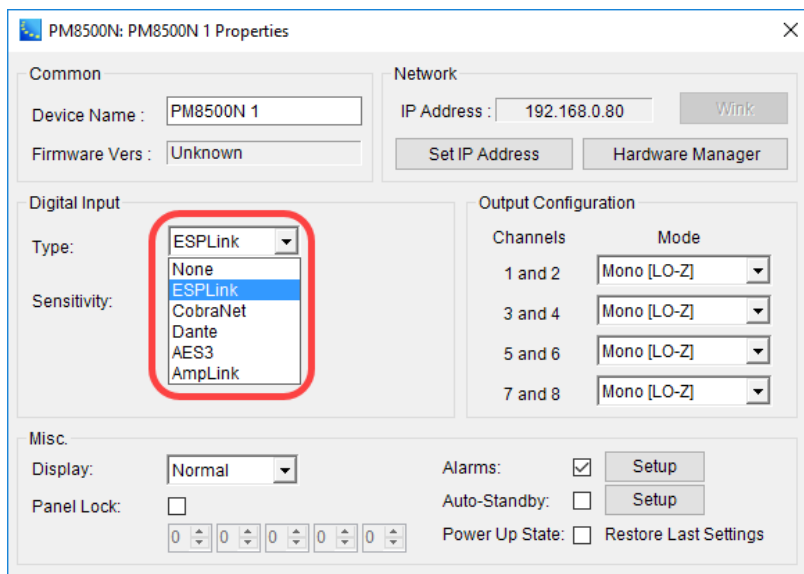

ESPLink card selected in PM8500N Properties

After selecting the ESPLink card, the Project View icon for the amplifier displays the ESPLink input connections.



PM8500N icon with ESPLink inputs

Dante™ Network Card

The Bose PowerMatch® configurable amplifiers, PM8500/8250/4500/4250, are capable of supporting up to 16 channels of high quality, uncompressed digital audio from a Dante digital audio network in an 8x8 configuration.

Defining the Dante™ Card Configuration

The Dante digital audio network card is added to the PM8500/8250/4500/4250 in the same manner as other expansion cards. If the card has already been fitted, it will be detected automatically when a hardware scan is performed. Otherwise, the card can be added manually to the system design as follows:

Right-click on the PM8500/8250/4500/4250 icon in Project View and select **Properties** to display the amplifier's Properties window. Select the Dante option from within the Digital Input drop-down list.

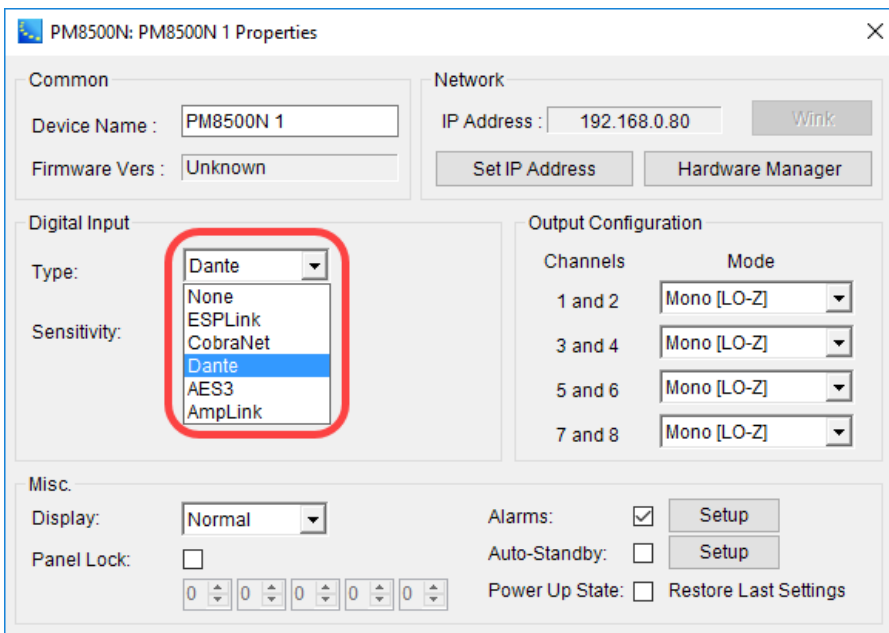

Dante Digital Audio Network Card option within PM8500/8250/4500/4250 Properties

After selecting the Dante network card, the Project View icon for the amplifier displays the Dante input/output connections.

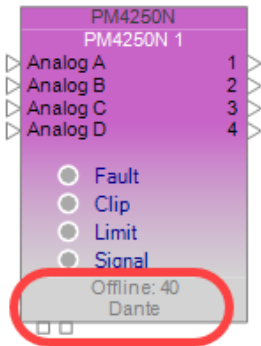

PM4250 icon with Dante input/output

Channel Selection (4-Channel Models Only)

PowerMatch amplifiers are capable of receiving 8 channels, or a single Flow, from a Dante digital audio network. When working with a four-channel PowerMatch amplifier it is possible to select between the two groups of four channels, channels 1-4 or channels 5-8, as the input source. This selection is made using the Channel Range drop-down list.

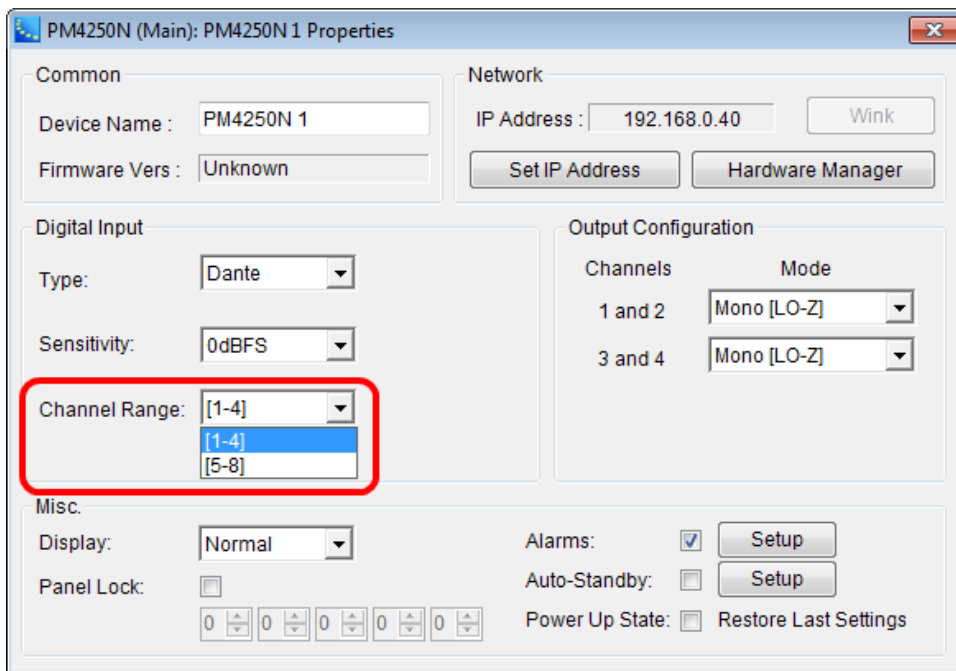

Digital Input Channel Range selection within PM4500/4250 Properties

For information on the Dante global properties control panel, see [Dante™ Network Device Properties](#).

Configuring the PowerMatch Dante™ Card Audio Monitor Bus

The PowerMatch Dante digital audio network card is capable of transmitting 8 audio channels for use as an audio monitor. In some situations, amplifiers are remotely located and this function may be used to remotely monitor the audio being sent by the amplifier to the loudspeaker.

Audio from the sound processor output for each channel is routed directly to the Dante transmit bus where it is available to be sent to other Dante receiving devices.

NOTE: The Dante transmit bus represents a “post-processing” stage - that is, it routes signals after all the DSP processing is completed. For example, if the output is muted, then the monitor signal is muted as well.

To enable the audio monitor bus, you must use the Routing function in the Dante Card Properties to configure the channel routing for the Dante network when sending audio from the PowerMatch Dante card.

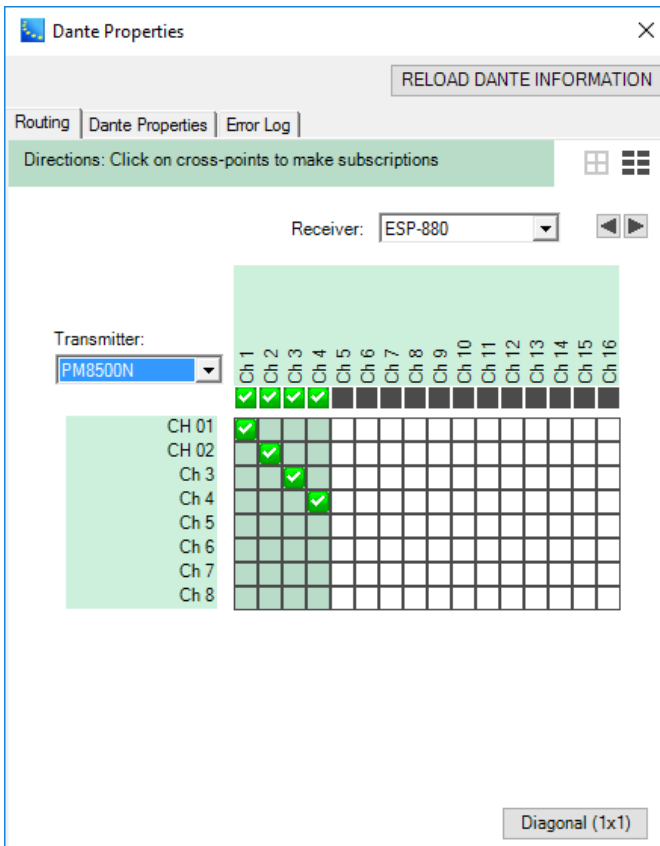

Network audio routing of monitor bus for PowerMatch amplifiers (PM8500N shown)

CobraNet® Network Expansion Card

The PowerMatch® CobraNet® card inserts into the digital input card slot of Bose® PowerMatch amplifiers and provides a up to 16 channels, (8 input and 8 output), of uncompressed 48 kHz digital audio using CobraNet audio networking. Designed for “plug and play” operation with the ControlSpace ESP CobraNet card, the PowerMatch CobraNet card provides a cost-effective means of distributing audio to multiple remote amplifiers.

To configure a PowerMatch amplifier for operation with a CobraNet input card, select the CobraNet option from within the list of available digital card types within the amplifier’s Properties.

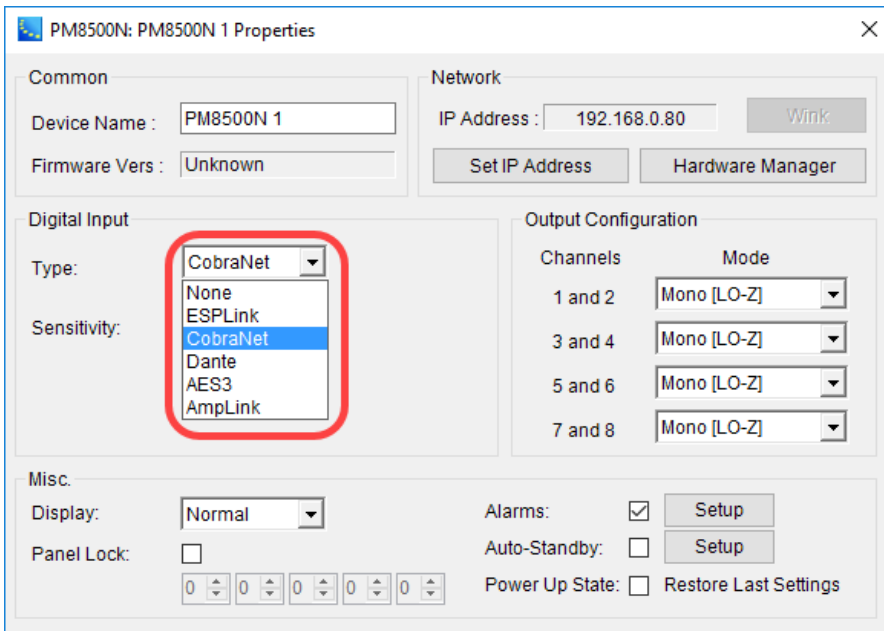

PowerMatch amplifier Properties – select CobraNet for Digital Card type

Once the PowerMatch CobraNet card is selected, the Project View icon for the amplifier displays CobraNet network connections.

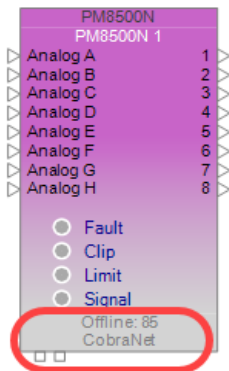

CobraNet I/O shown on the Project View icon

The PowerMatch CobraNet card ships pre-configured to receive 8 channels of audio on Bundle number 100, while the audio monitor bus is disabled. When configuring the system for operation with a ControlSpace ESP CobraNet card, do the following:

1. Configure the ESP for use with a CobraNet card. The configuration should include, at a minimum, 8 channels of CobraNet audio output.
2. Configure the amplifier for operation with a CobraNet input card.
3. From within the ESP-00 II signal processing view, select the CobraNet output control panel.
4. Assign the Transmit bundle to bundle address 100.

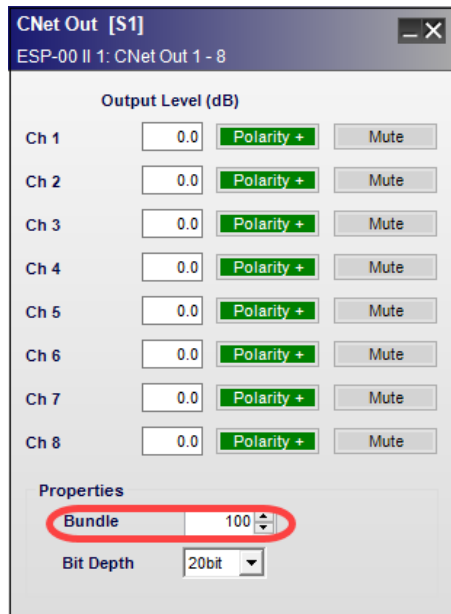

CobraNet bundle assignment within the ESP

5. Route audio to the CobraNet outputs.

At this point you will have successfully routed audio from the ESP to a PowerMatch amplifier.

NOTE: The ControlSpace Network and CobraNet audio network must be physically separate networks using separate routers/switches. However, if you are using a managed switch you can configure the CobraNet audio network to use a dedicated VLAN for CobraNet network traffic.

For information relating to recommended network set up and design practices for CobraNet audio see www.CobraNet.info.

Configuring the PowerMatch CobraNet Card Audio Monitor Bus

The PowerMatch CobraNet[®] is capable of transmitting 8 audio channels for use as an audio monitor. In some situations, amplifiers are remotely located and this function may be used to remotely monitor the audio being sent by the amplifier to the loudspeaker.

Audio from the sound processor output for each channel is routed directly to the CobraNet transmit bus, where it is available to be sent to other CobraNet receiving devices.

NOTE: This is a “post-processing” signal that is after all the sound processing. If, for example, the output is muted, then the monitor signal will be muted as well.

The default bundle assignment is 0, indicating that the audio is not being placed on the larger network. To enable the audio monitor bus you must use CobraNet Discovery to configure the PowerMatch CobraNet card.

NOTE: CobraNet Discovery is available at www.CobraNet.info.

To configure the PowerMatch CobraNet card audio monitor bus, use the following steps:

1. Ensure that your network adapter is correctly configured and connected to the CobraNet network, rather than the ControlSpace network.
2. Launch CobraNet Discovery – any CobraNet devices will be discovered.

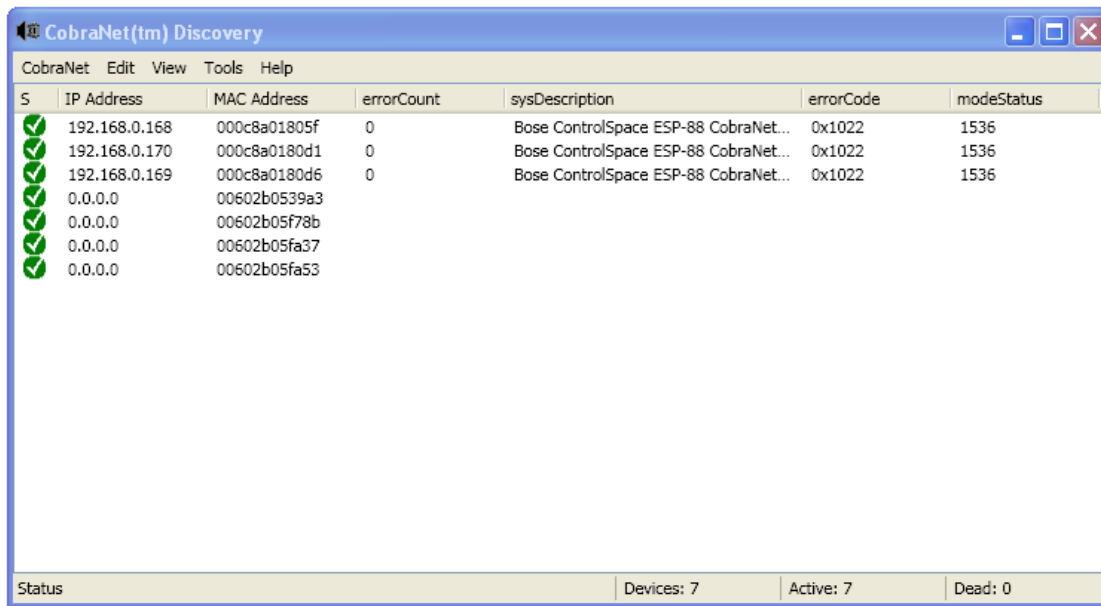

CobraNet Discovery interface

- It will be necessary to configure the PowerMatch devices with an IP address to configure the CobraNet settings. Select one of the devices within the device list, and choose New IP Address from the CobraNet menu. Alternatively you can configure CobraNet Discovery to automatically assign devices an IP address. To do this select the Enable Auto Assignment option within the CobraNet Discovery Options dialog.

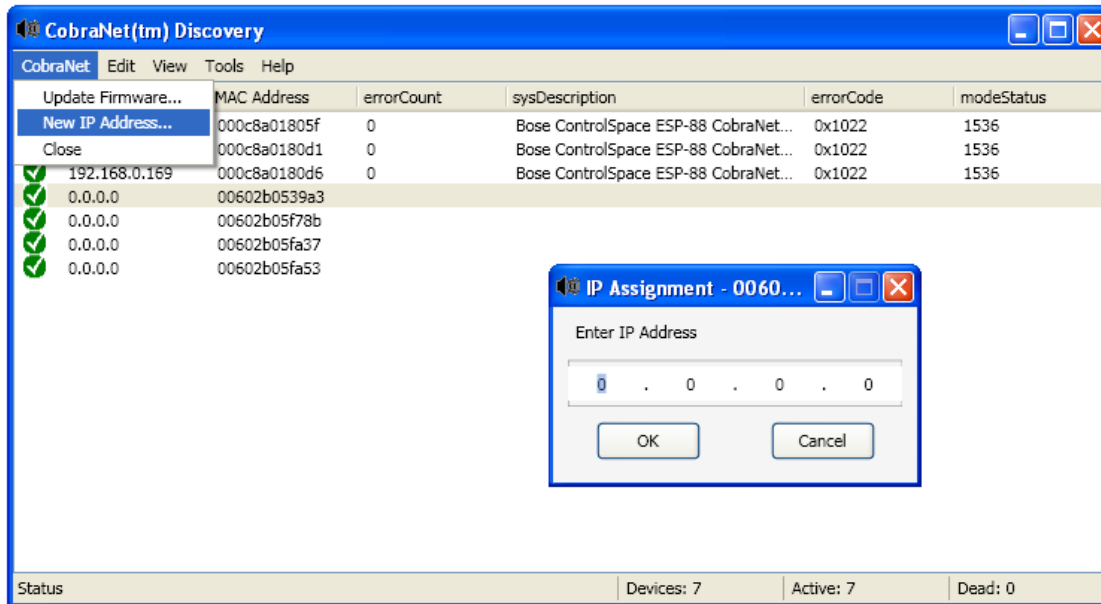

Assign an IP address to CobraNet devices

Once IP addresses are assigned the device list is refreshed and details about the device's configuration are displayed.

S	IP Address	MAC Address	errorCount	sysDescription	errorCode	modeStatus
✓	192.168.0.168	000c8a01805f	0	Bose ControlSpace ESP-88 CobraNet...	0x1022	1536
✓	192.168.0.170	000c8a0180d1	0	Bose ControlSpace ESP-88 CobraNet...	0x1022	1536
✓	192.168.0.169	000c8a0180d6	0	Bose ControlSpace ESP-88 CobraNet...	0x1022	1536
✓	192.168.0.13	00602b0539a3	0	Cirrus Logic EV-2/CM-2 (CM49611)...	0x3D	1536
✓	192.168.0.11	00602b05f78b	0	Cirrus Logic EV-2/CM-2 (CM18101)...	0x3D	1536
✓	192.168.0.14	00602b05fa37	0	Cirrus Logic EV-2/CM-2 (CM18101)...	0x3D	1536
✓	192.168.0.10	00602b05fa53	0	Cirrus Logic EV-2/CM-2 (CM18101)...	0x3D	1536

CobraNet device list showing device properties

4. Select one of the PowerMatch amplifiers and select “Configure” from the Tools menu. This will cause the configuration settings for the device to be displayed:

Bundle	Type	Number	Status
0	Tx	1	0
0	Tx	2	0
0	Tx	3	0
0	Tx	4	0
100	Rx	1	0
0	Rx	2	0
0	Rx	3	0
0	Rx	4	0
0	Rx	5	0
0	Rx	6	0
0	Rx	7	0
0	Rx	8	0

CobraNet configuration for a PowerMatch amplifier

5. From within the Configuration settings panel select the first Tx bundle and click “Configure” to display and configure the Transmit bundle settings. Enter a bundle assignment for the Transmit bundle. Bundles 1-255 are Multicast bundles, and bundles greater than 256 are:

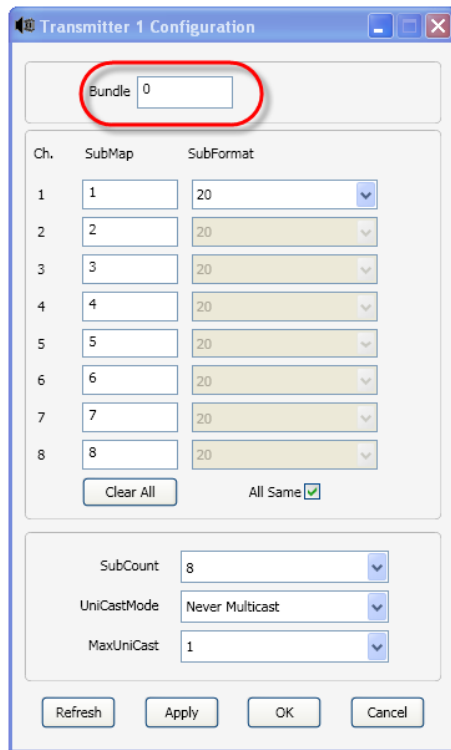

Bundle assignment for PowerMatch amplifiers

NOTE: Use Unicast bundle assignments to better manage network bandwidth.

6. Set the receive bundle of the receiving CobraNet device to the same as the amplifier transmit bundle. For additional information and application examples related to the set-up and configuration of Bose system electronics which employ CobraNet network audio see pro.Bose.com. Application notes are available within the ControlSpace® Designer™ software area of the site.

AES3 Digital Input Card

This expansion card provides a PowerMatch® amplifier with eight channels of AES3 digital audio input.

To configure a PowerMatch amplifier for operation with an AES3 digital input card, select the AES3 option from within the list of available digital card types within the amplifier's Properties.

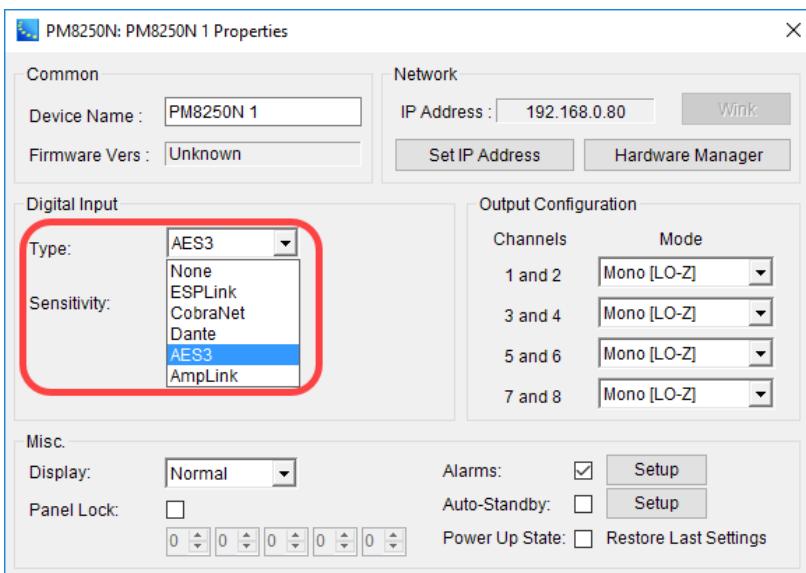

AES3 card selected in PM8250N Properties

After selecting the AES3 card, the Project View icon for the amplifier displays the AES3 input connections.

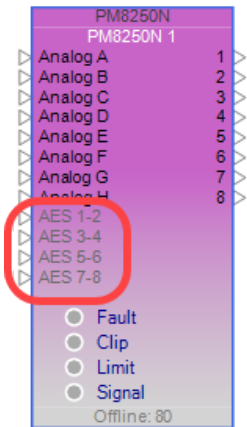

PM8250N icon with AES3 inputs

Adjustable options for this card are accessed by double clicking on any input block within the signal processing view to open the control panel.

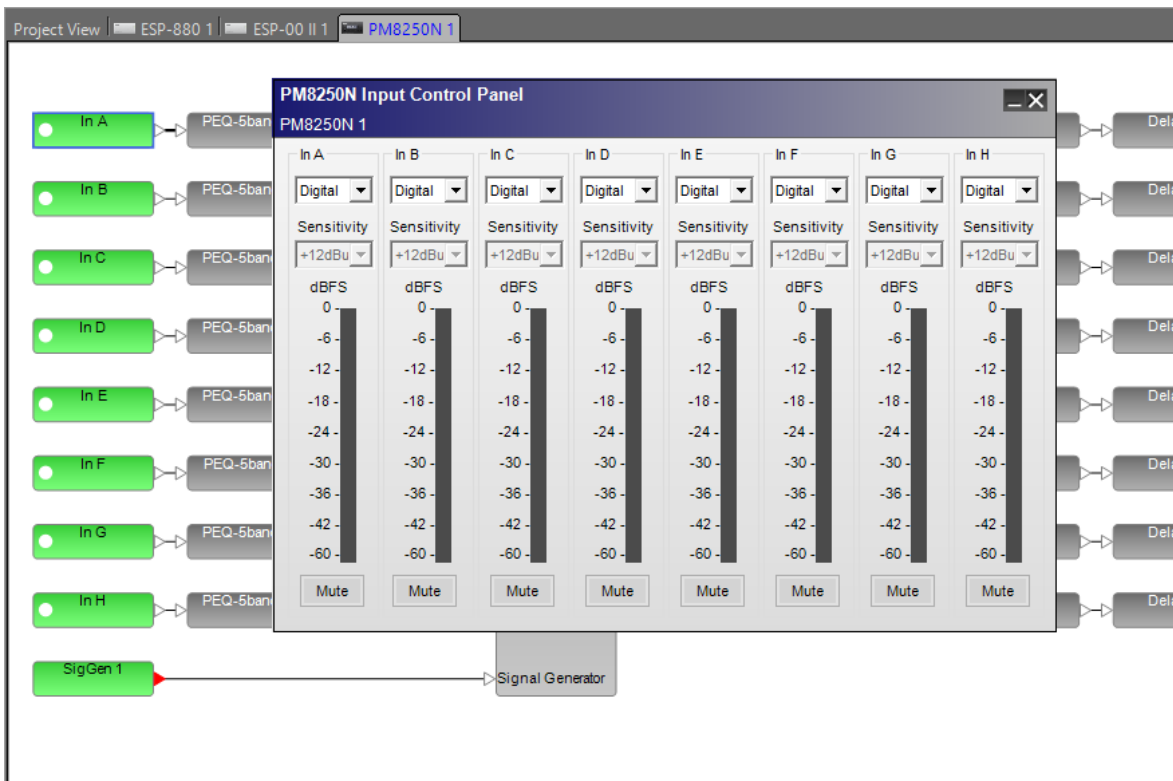

AES3 eight-channel input card control panel

The **Input Control Panel** provides the following options for each channel:

Input Channel Label – Default channel label is “In *n*” and reflects the label applied in the Signal Processing view.

Input Source Select – Select the desired input source – analog or digital for each input. The digital selection is available when an AES3 input card is installed.

Input Channel Sensitivity – (Analog inputs only.) Select the desired input signal level to drive the PowerMatch amplifier to its full output. Digital input sensitivity is found in the PM8250 properties panel.

Input Channel Signal Level Meter – Displays the current input signal level and is scaled to 0 dBFS and OFF (-inf or MUTE). The meter is monitoring the signal level post A/D conversion, and is monitoring the RMS signal level.

Input Channel Mute – Applies a full mute (no audio) to the selected input channel. When the input is in a mute state the input meter is still active as a reference.

AmpLink 24-Channel Input Card

The AmpLink accessory card installs into the digital input slot of the PowerMatch[®] amplifiers. It receives 24 digital audio channels from a ControlSpace[®] sound processor or from another PowerMatch[®] amplifier's THRU connection. You can select a bank of eight channels of audio at a time to amplify through a three-position bank select switch on the amplifier.

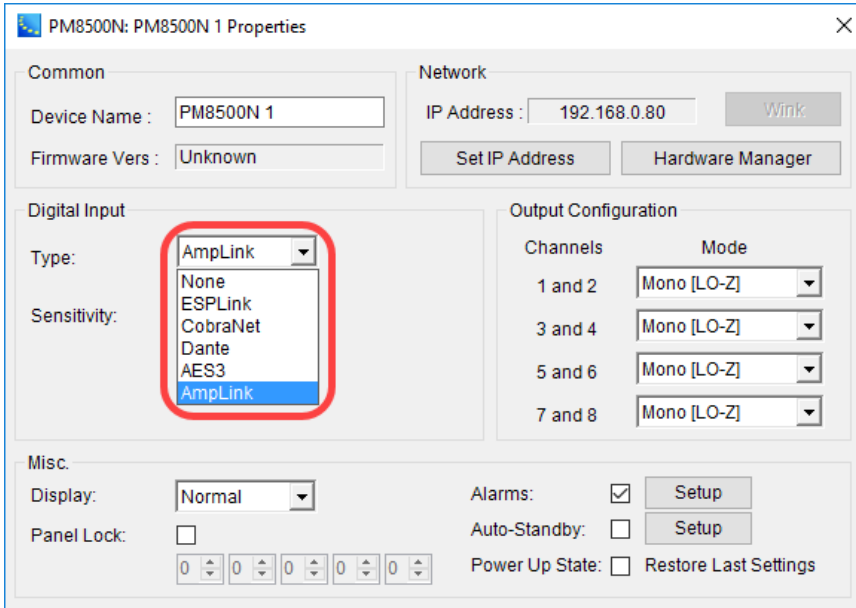

AmpLink card selected in PM8500N Properties

After selecting the AmpLink card, the Project View icon for the amplifier displays the AmpLink input connections.

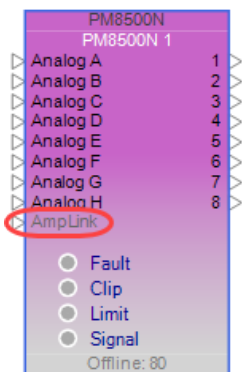

PM8500N device block with AmpLink inputs

Adjustable options for this card are accessed by double clicking any input block within the Signal Processing View to open the control panel. For a description, see [Input Control](#).

Configuring Dante Networks

Dante™ Network Device Properties

The global Dante Properties control panel for a Dante network device is accessible in any of these ways:

- Select **Dante Properties** in the System menu.
- Right click a Dante endpoint or other device block in Project View and select **Dante Properties**.
- Right click a Dante endpoint or Dante I/O block in the Signal Processing View and select **Dante Properties**.
- Click the **Dante Properties** button  in the toolbar.

The global Dante Properties control panel contains three main tabs:

- Dante Properties
- Routing
- Error Log

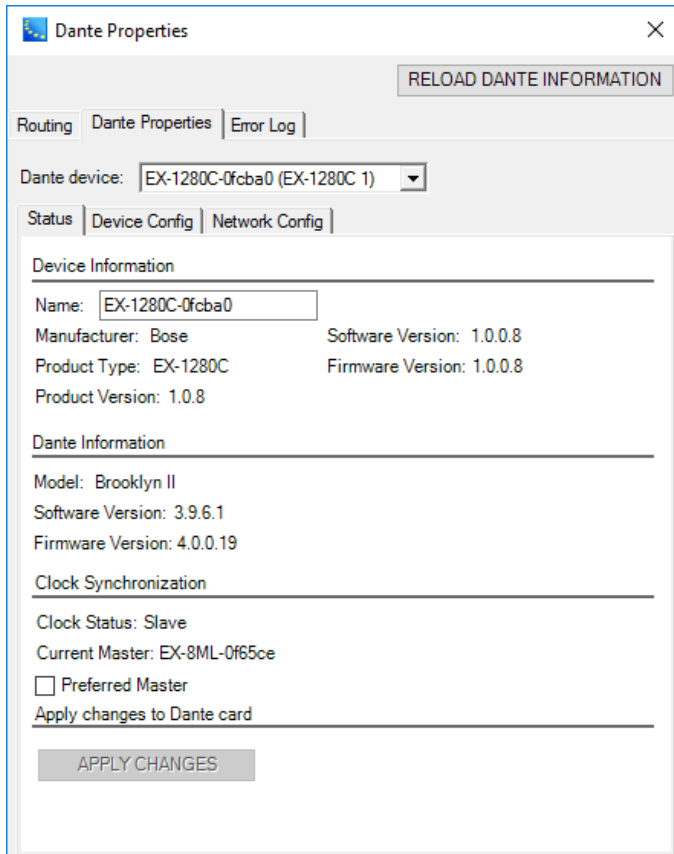

Dante Properties tab on control panel

You can use the Dante Device drop-down list to select a specific Dante device or endpoint for display.

The **RELOAD DANTE INFORMATION** button at the top of the panel can be used to reload Dante network information from the selected host device.

If Dante Properties information does not appear in this panel, you may see one or more error messages on your screen that indicates the Dante network is unavailable.

- If Dante services are not running:

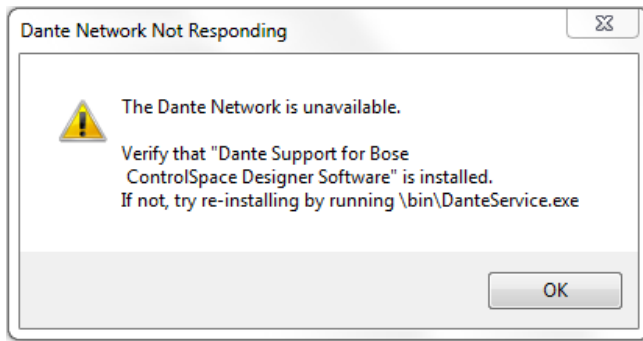

Dante network not responding message

- If the network interface address does not match the ControlSpace Designer software network address (see [Project Network Address](#)):

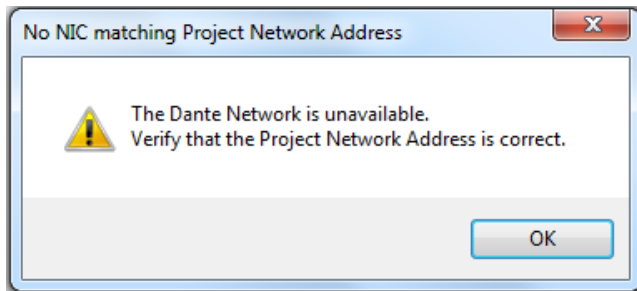

Project Network Address error message

NOTE: For information on programming Dante devices, see [Programming With Composite Device Blocks](#).

Dante Properties Tab

Dante properties for the host device are organized under three sub-tabs:

- Status
- Device Config
- Network Config

Status Tab

The Status tab provides information about the Dante card located in the host device.

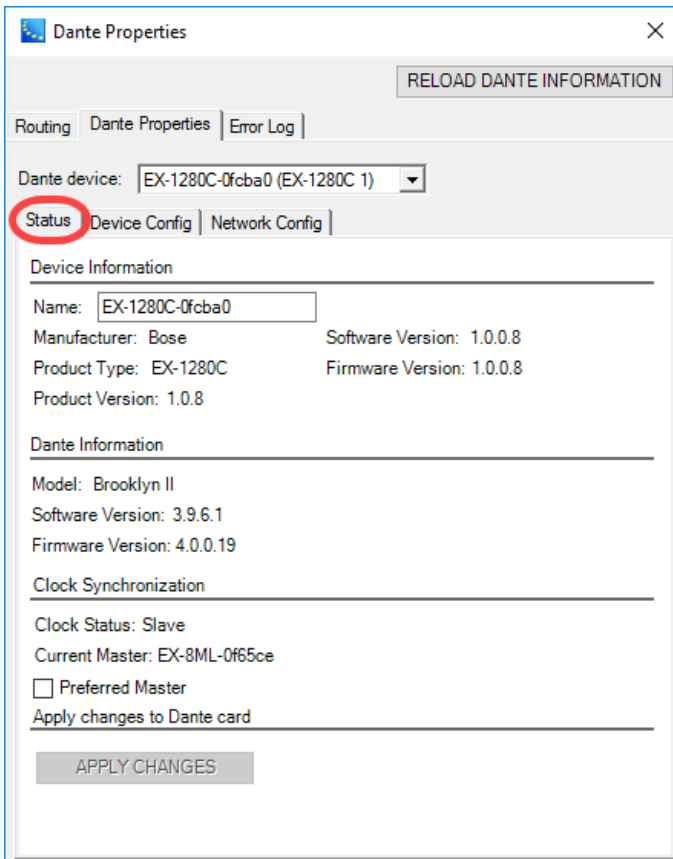

Dante Device Status

Device Information - Provides details about the selected Dante device. The **Name** field allows you to edit the Dante device name. After changing the name, click the **APPLY CHANGES** button to save the new name.

UPDATE FIRMWARE - This button (not shown) launches the Audinate Dante Firmware Update Manager which is used to update the firmware in Dante network devices (see [Updating Firmware in Bose® Dante Network Cards](#)). This button appears only when a firmware update is available. **NOTE: You can also launch the same Audinate Dante Firmware Update Manager from the Hardware Manager's Device List Tabs in CSD.**

Dante Information - Provides Dante software/firmware version details. Includes a notice when new firmware is available.

Clock Synchronization - Displays the clock status for the selected host device and the name of the device that currently provides the master clock. Selecting the **Preferred Master** check box prioritizes the named Dante device to be master.

All Dante-enabled devices use the IEEE 1588 Precision Time Protocol (PTP) to synchronize their local clocks to a master clock.

One Dante device will be elected as the PTP Master Clock for the network; all other Dante devices act as a PTP Slave Clocks to the elected master clock. Although many Dante devices may be capable of becoming PTP Master Clock, only one device will win the election.

Sometimes it may be necessary to force a particular device to provide the PTP Master Clock. A Dante device with a **Preferred Master** option will always be chosen as the PTP Master Clock. If more than one device has a **Preferred Master** option, the device with the lowest MAC address will be chosen.

Device Config Tab

The Device Config tab displays the current Sample Rate and a list of selectable, recommended Device Latency settings for the host device. The typical default latency is 1 msec for a Dante device. A latency of 1

msec is sufficient for a very large network with a Gigabit network core and 100 megabit links to Dante devices. Smaller networks can use lower latency values.

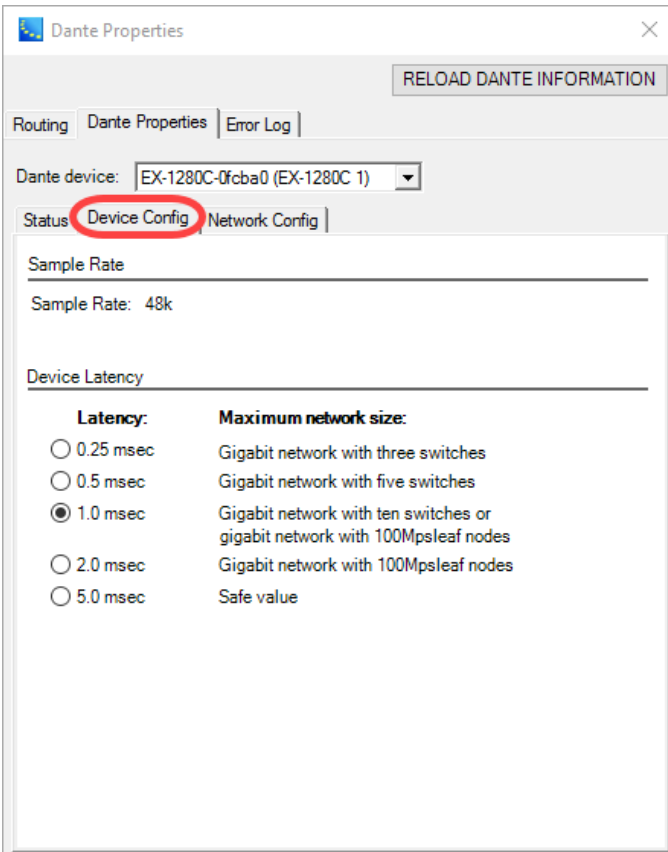

Dante Device Configuration information

NOTE: Changing the Device Latency setting generates a warning dialog.

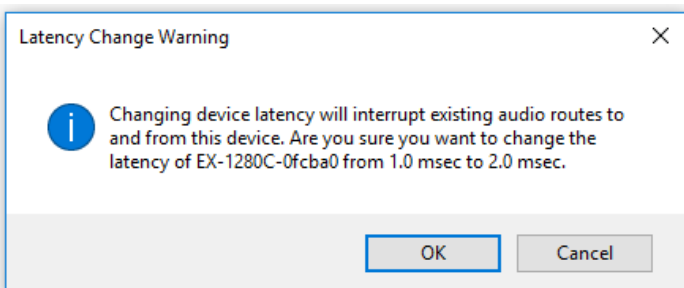

Click **OK** to make the change or click **Cancel** to leave the setting as is.

Network Config Tab

The Network Config tab provides access to the network configuration settings for the host device.

Dante Device Network Configuration settings

Switch Configurations

Current: - The current switch configuration setting for the Dante device.

New: - A drop-down list for selecting the port configuration.

Configuration	Primary Port Function	Secondary Port Function	Notes
Switched (Default)	ControlSpace control Dante audio	ControlSpace control Dante audio	Use secondary port for daisy-chaining devices.
Legacy Hardware	Dante audio	ControlSpace control	Use secondary port for control-only connections to legacy hardware such as the CC-64.
Redundant	ControlSpace control Dante audio	Dante redundant audio	Use secondary port for a redundant audio network in critical installations.
Isolated Networks*	Dante audio	ControlSpace control	Use Primary port only for Dante Audio and Secondary port only for ControlSpace control.

*Available only for ESP-880, ESP-1240, ESP-4120, and EX-1280C processors

Primary/Secondary Port Addresses - Selection determines how the IP address is set, automatically (default) or manually.

- 1. APPLY CHANGES** - Becomes active when changes are made. Click to apply changes to Dante device.
- 2. Reboot Host Device** - After clicking **APPLY CHANGES**, reboot the Dante device to enable the changes.

NOTE: Changes can only be applied when the Dante device is offline.

Error Log Tab

Shows a log of any Dante-related error messages.

Dante Network Routing

Dante network routing is configured within the Routing tab in the **Dante™ Network Device Properties** control panel.

Two views are available in the Routing tab: **Matrix View** (default) and **Drag and Drop View**. These views are selected by clicking the related icon in the upper-right corner of the panel.

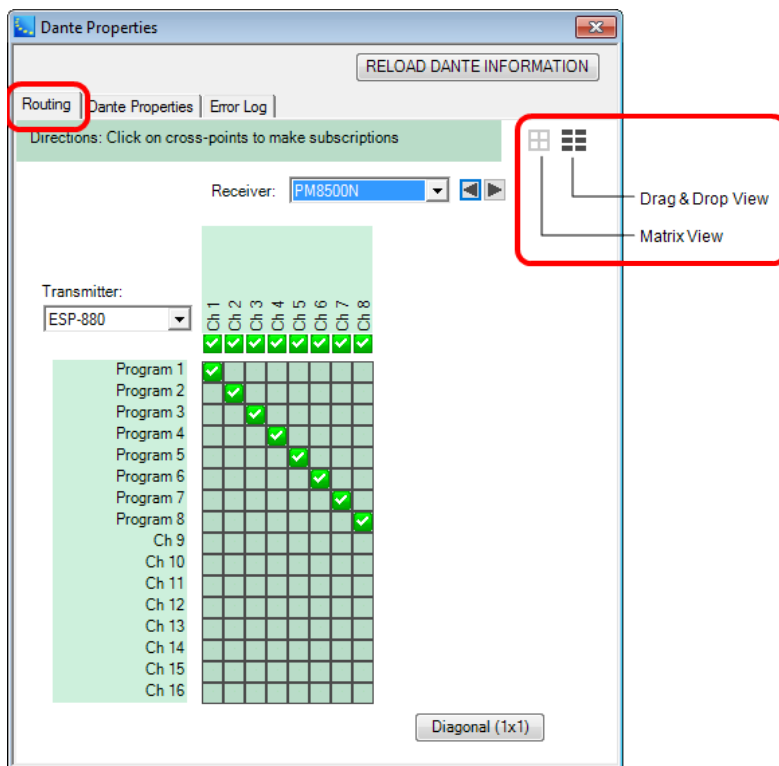

Dante Properties - Routing tab

Matrix View





The Matrix View allows you to configure subscriptions by just clicking.

A drop-down list of Dante-enabled **Transmitter** devices is found on the left of the matrix with transmitting channels listed vertically. A drop-down list of **Receiver** devices is on the top with receiving channels listed horizontally. For devices that have too many channels to fully display in Matrix View, click the arrow buttons next to the device name to scroll the channel listing.

To make a subscription, click on the intersection of a transmitter channel and a receiver channel in the matrix. To delete a subscription, click on the channel intersection again.

The icon displayed at that intersection indicates the connection status:

No subscription

-  Subscription connection in progress
-  Subscription connection complete
-  Unresolved subscription
-  Error

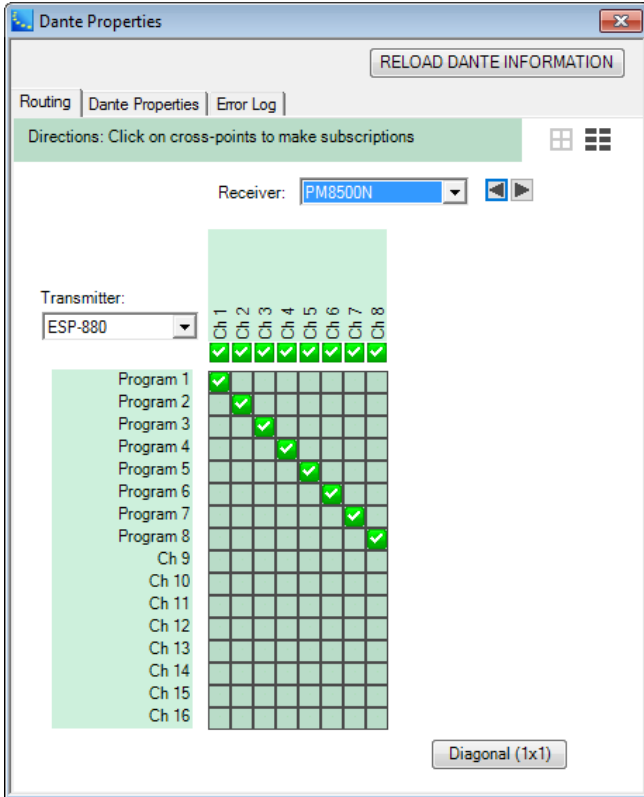

Dante Properties - Routing Matrix View

The Matrix view has the following features:

Transmitter: - Selects the Dante transmitting device.

Receiver: - Selects the Dante receiving device.

Diagonal (1x1) - Makes 1x1 subscriptions diagonally across the selected receiving and transmitting devices. Click again to undo.

Drag and Drop View

The Drag and Drop View allows you to configure subscriptions using the drag and drop method. Also, you can create and view unicast and multicast flows.

The Drag and Drop View shows the available **Transmitting Dante devices** and their channels on the left and the selected **Receiving Dante** device and its channels on the right.

To view the transmitting channels, click on the arrow to the left of the device name.

The image displays two screenshots of the Dante Properties window, illustrating the Routing Drag and Drop View. The top screenshot shows the 'Transmitting Dante devices' list with 'EX-8ML-0f65ce' highlighted. A red arrow points down to the bottom screenshot, which shows the expanded view of 'EX-8ML-0f65ce' with its sub-channels (BOSE TX CH01-CH08) and their 'unicast' status.

Transmitting Dante devices (Top Screenshot):

Transmitting channel	Signal	Transmit Flow
EX-1280C-0fcba0 (EX-1280C 1)		
EX-8ML-0f65ce		

Receiving Dante device: EX-1280C-0fcba0 (EX-1280C 1)

Receiving channel	Signal	Connected to	Status	Receive Flow
01	BOSE TX CH01@EX...		✓	•→
02	BOSE TX CH02@EX...		✓	•→
03	BOSE TX CH03@EX...		✓	•→
04	BOSE TX CH04@EX...		✓	•→
05	BOSE TX CH05@EX...		✓	•→
06	BOSE TX CH06@EX...		✓	•→
07	BOSE TX CH07@EX...		✓	•→
08	BOSE TX CH08@EX...		✓	•→

Transmitting Dante devices (Bottom Screenshot):

Transmitting channel	Signal	Transmit Flow
EX-1280C-0fcba0 (EX-1280C 1)		
EX-8ML-0f65ce		edit multicast flows +
BOSE TX CH01		•→ unicast
BOSE TX CH02		•→ unicast
BOSE TX CH03		•→ unicast
BOSE TX CH04		•→ unicast
BOSE TX CH05		•→ unicast
BOSE TX CH06		•→ unicast
BOSE TX CH07		•→ unicast
BOSE TX CH08		•→ unicast

Receiving Dante device: EX-1280C-0fcba0 (EX-1280C 1)

Receiving channel	Signal	Connected to	Status	Receive Flow
01	BOSE TX CH01@EX...		✓	•→
02	BOSE TX CH02@EX...		✓	•→
03	BOSE TX CH03@EX...		✓	•→
04	BOSE TX CH04@EX...		✓	•→
05	BOSE TX CH05@EX...		✓	•→
06	BOSE TX CH06@EX...		✓	•→
07	BOSE TX CH07@EX...		✓	•→
08	BOSE TX CH08@EX...		✓	•→
09				
10				
11				
12				
13	Ch 13@DNC-E-06ca...		⚠	•→
14	Ch 14@DNC-E-06ca...		⚠	•→
15	Ch 15@DNC-E-06ca...		⚠	•→
16	Ch 16@DNC-E-06ca...		⚠	•→
17				
18				
19				
20				
21				
22				
23				
24				

Dante Properties - Routing Drag and Drop View

NOTE: To change the name of a channel, highlight the channel name, enter the new name and press Enter. The channel name is automatically updated in the Signal Processing View and, if applicable, in a multicast flow.

To make a subscription, click and drag a transmitting channel and drop it on a receiving channel.

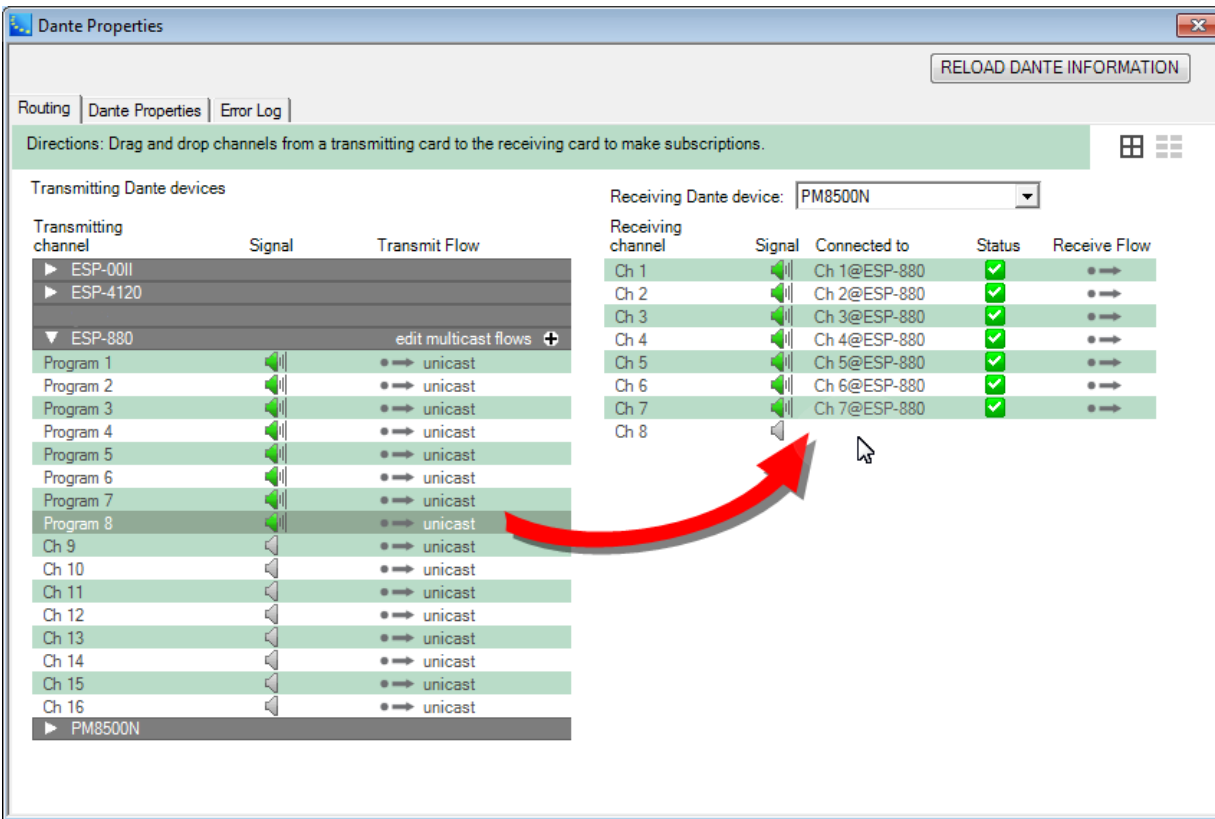

Making a subscription in Drag and Drop View

The speaker icon  indicates signal status:

Gray = No signal present, channel is muted, or receiving audio at less than -61 dbFS.

Faded Gray = device does not support metering.

Green = Channel is receiving audio between -61 dbFS and 0 dbFS.

Red = Channel is clipping.

To remove a subscription, while hovering the cursor over the channel to delete, right click and then click **Delete Subscription**.

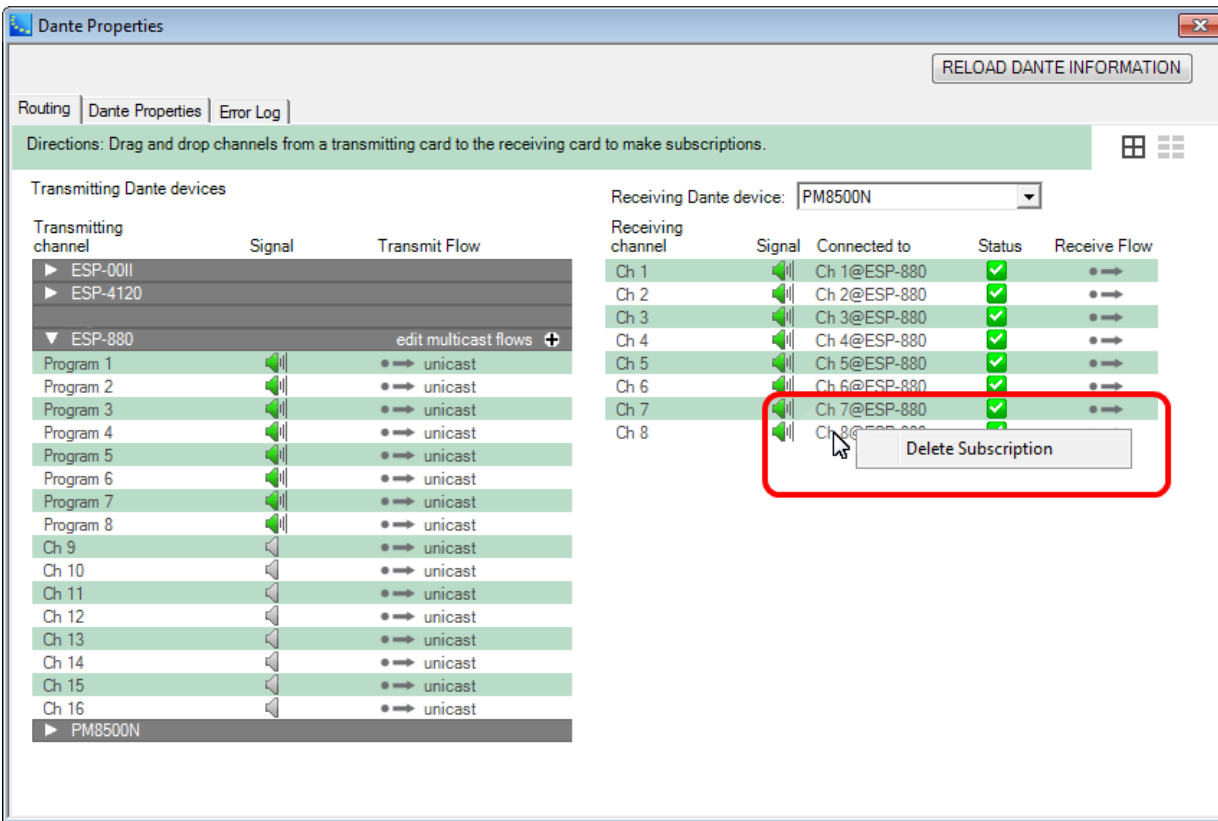

Deleting a subscription in the Drag and Drop View.

Multicast Flows

Routing Dante audio creates flows that carry one or more audio channels from a transmitting device to one or more receiving devices. A **Unicast** flow (default transmit flow) carries an audio channel to a single receiving device. A **Multicast** flow can be received by multiple receiving devices.

To add a new Multicast flow or edit existing ones, open the channel list for a transmitting device and click the plus icon **+** next to **edit multicast flows**. This opens the Multicast flow editing panel.

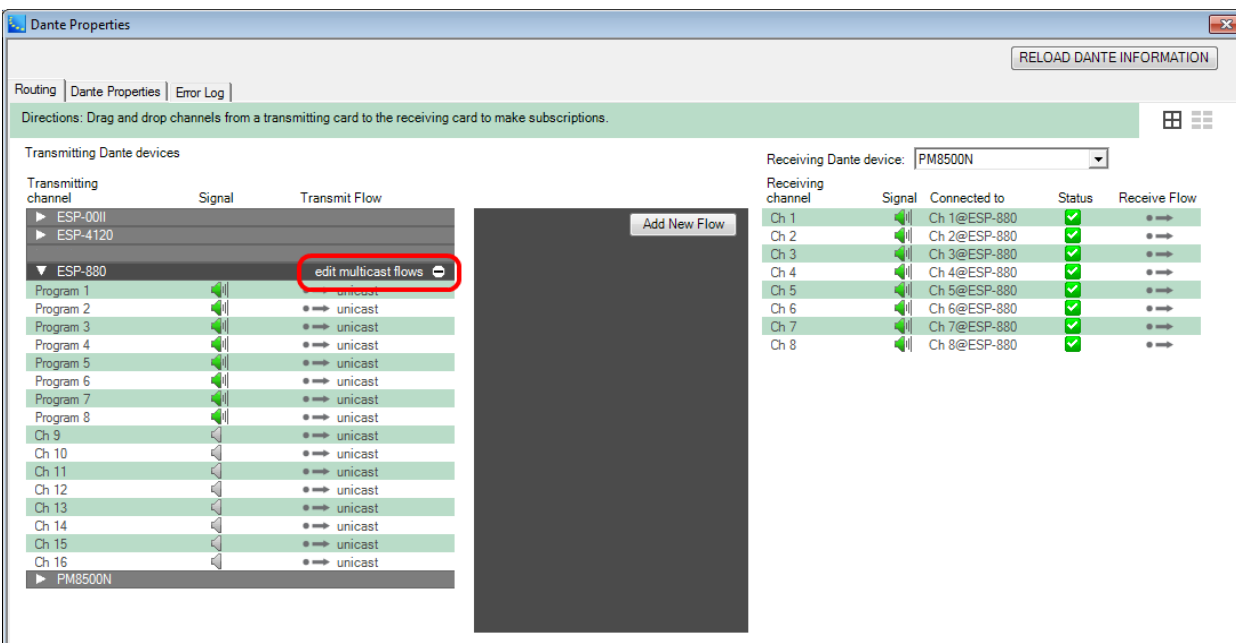

Opening the Multicast Editing panel

Click the **Add New Flow** button. Text fields appear on the panel. The first field is the name of the flow. The name can be edited. The second field defines the channels in the flow.

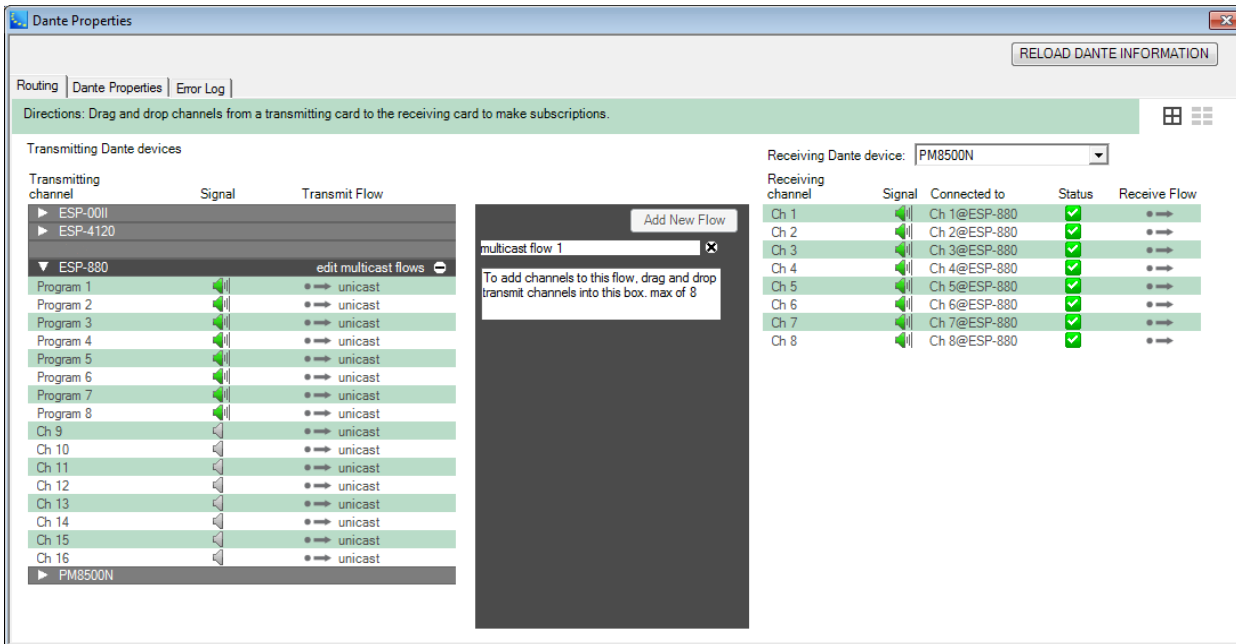

Multicast panel text fields

To create a Multicast flow, click and drag a Transmitter channel into the panel.

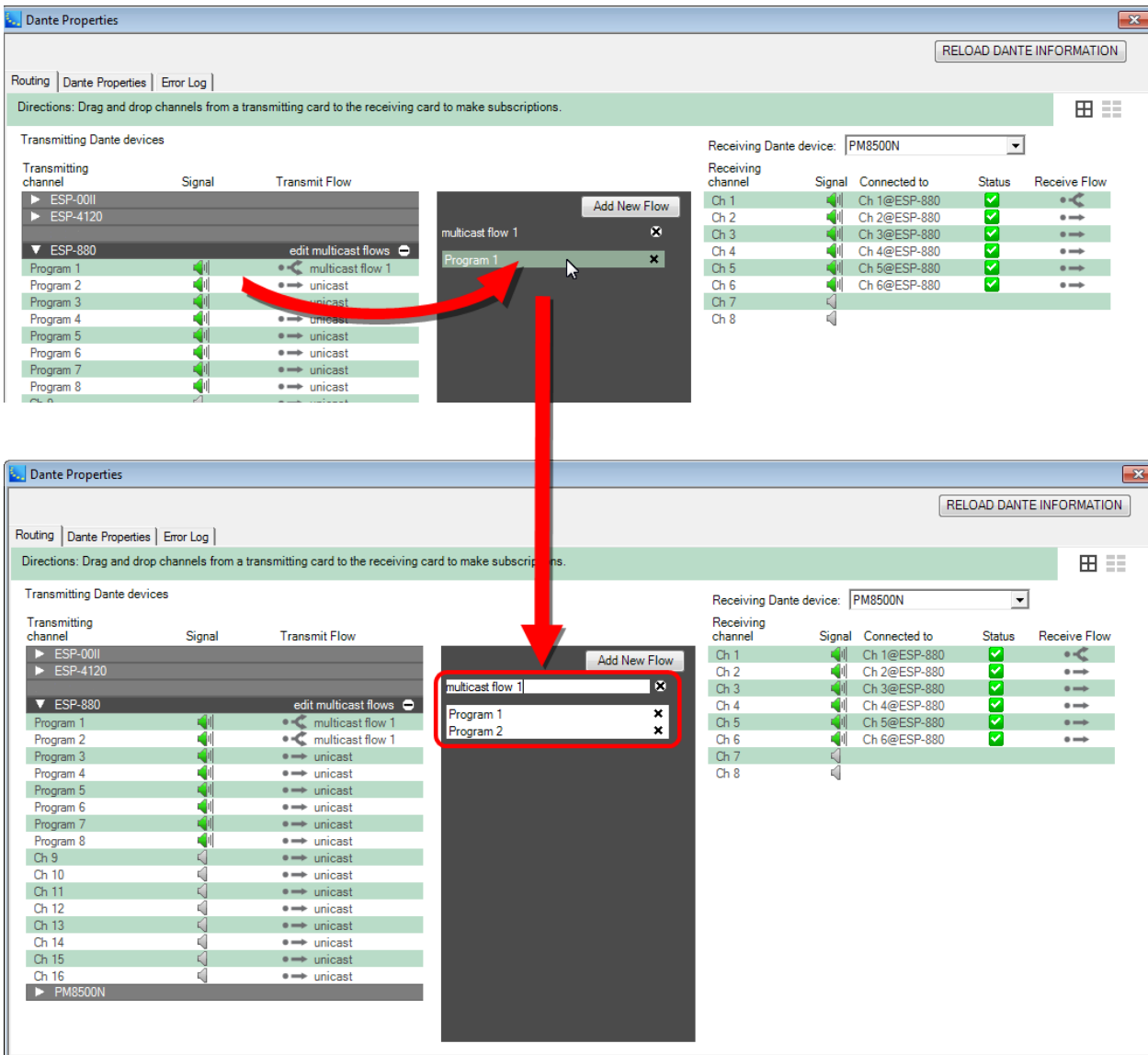

Creating a multicast flow

To add another Multicast flow, click the **Add New Flow** button again.

To delete a channel in the flow or the entire flow, click the **X** to the right of the channel name or multicast flow name.

To close the panel, click the minus icon  next to **edit multicast flows**.

NOTES on Multicast Flows

- Unicast flows are not listed here, only multicast flows.
- Flows are created with the maximum number of channel slots for that device. For example, Bose Dante devices support 8-channel flows, so each flow created can hold up to 8 channels. The number of slots a flow can hold cannot be changed after it is created.
- The number of possible flows is also dependent on the device type. Bose devices support up to 32 flows.
- You can only drag unicast flows into multicast flows. A channel can only be in one multicast flow at a time, no duplicates.

- You can rename flows by editing the text box above the channels.
- New flows cannot be added while there is already an empty flow in that device.
- Deleting a multicast flow may interrupt audio.
- It is preferable to use unicast flows for routing the same signal to up to four devices. For more than four devices it is better to use multicast flows, but then the data is sent to all devices irrespective of whether the audio channel is routed or not.

Configuring Dante Endpoints

Adding Dante Endpoints and Microphones to Project View

Automatic Discovery

If you are connected to the system network, CSD by default will discover any Dante endpoints and Dante-equipped microphones that are connected to that same network. Once detected, the discovered endpoint and mic device blocks will automatically display in Project View – even if CSD is not in online mode.

The "Connected" label inside the device block indicates that the Dante block is both connected to the network and associated with the actual Dante hardware. If the association were not made, a "Disconnected" label would appear.

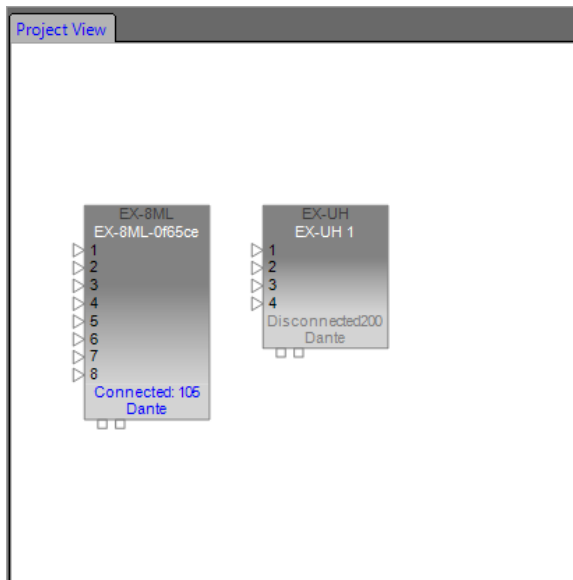

Dante endpoint device blocks - Connected and Disconnected

This association is also reflected in the Dante device block's control panel. The blue Connected light indicates that the hardware endpoint is associated with and connected to the device block (a gray color means no associated connection). See [Device Icons/Controls for Dante Endpoints](#) and [Device Icons/Controls for Dante-Equipped Microphone Endpoints](#) for a description of Dante device control panels.

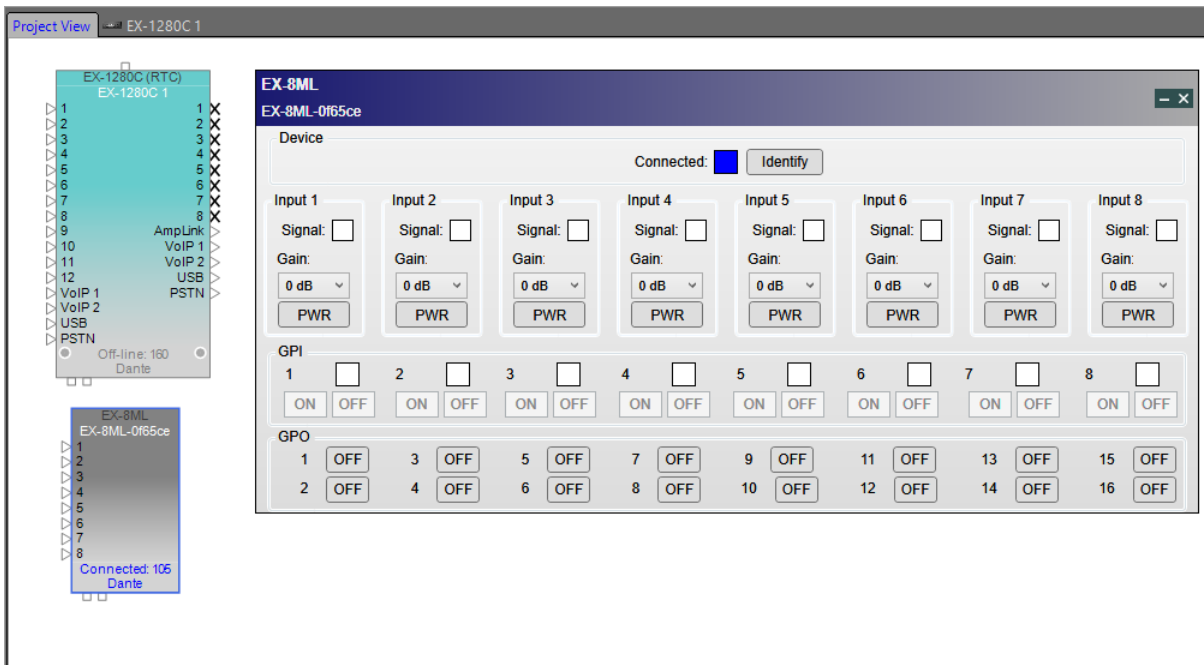

Connected indicator in Dante device block control panel

Adding Dante Devices Manually

Since Project View is automatically populated with any Dante devices that are discovered on the network, it is usually not necessary to add Dante devices manually unless you delete a device and decide to add it back to Project View later.

There are two ways to add a Dante device manually:

- Use the **Add Dante Endpoints** command in the System menu.
- Use the drag and drop method, described below.

To add Dante devices to Project View manually with the drag and drop method:

1. In the Device List, expand the Dante Endpoints category listing.
2. Drag and drop the Dante endpoint or Dante-equipped microphone block into Project View.

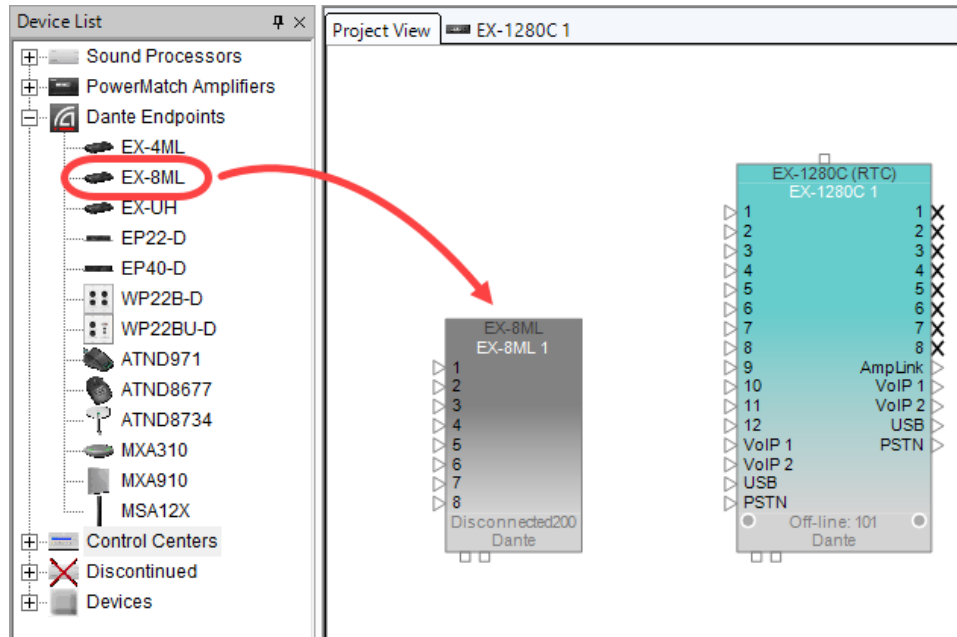

Dante Endpoint dragged into Project View

3. If Dante hardware matching the Dante device block is found on the network, select the Dante hardware device name in the drop-down list in the Associate with Dante Device dialog.

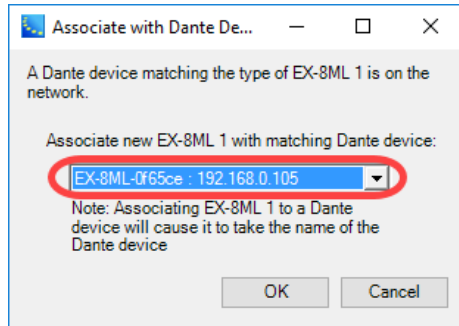
*Associating Dante device block with hardware endpoint*

4. Click **OK**. The Dante device block now shows a status of "Connected," which means it is now associated with matching hardware on the network.

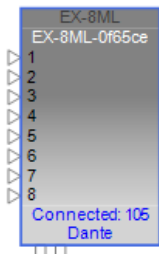
*Dante device block in Connected state*

To add signal processing blocks for the Dante device to Signal Processing View, see [Adding Dante Endpoint and Microphone Blocks to SP View](#).

Device Icons/Controls for Dante Endpoints

Dante endpoints, other than microphones, can be found in the Device List in the Dante Endpoints folder:

- EX-4ML 4-mic/line input Dante endpoint
- EX-8ML 8-mic/line input Dante endpoint
- EX-UH USB input Dante endpoint
- EP22-D 2-in/2-out Dante endpoint
- EP40-D 4-input Dante endpoint
- WP22B-D 2-in/2-out Dante Wall Plate
- WP22BU-D 2-in/2-out Dante Wall Plate
- MSA12X Dante Steerable Loudspeaker Array

NOTE: For Dante-equipped microphone endpoints, see [Device Icons/Controls for Dante-Equipped Microphone Endpoints](#).

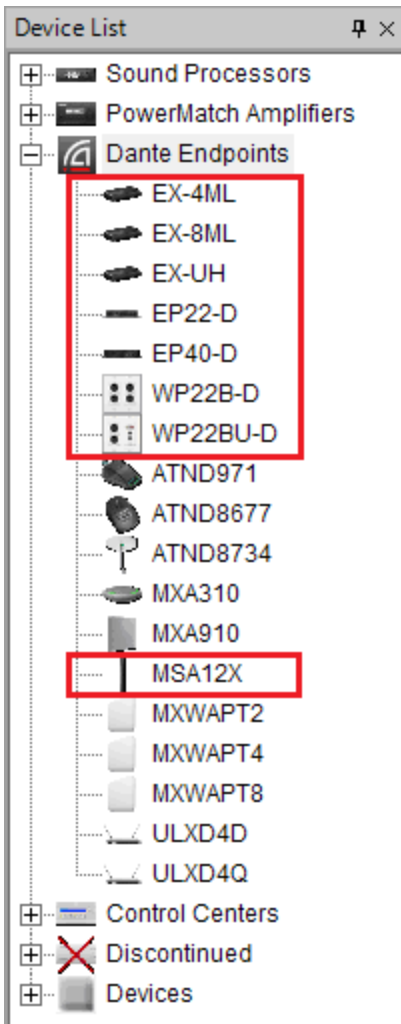

Dante endpoints on Device List

The devices will also appear as icons in Project view, once they are either automatically discovered on the network or manually dragged and dropped into Project View. These devices have properties and a control panel that allows you to view and modify these properties. The Properties Window displays the list of properties and allows direct interaction for modifying their values.

NOTE: Each device's control panel has an **Identify** button. Clicking this button triggers a flashing Power/ID indicator on the device, which continues until reset.

EX-4ML

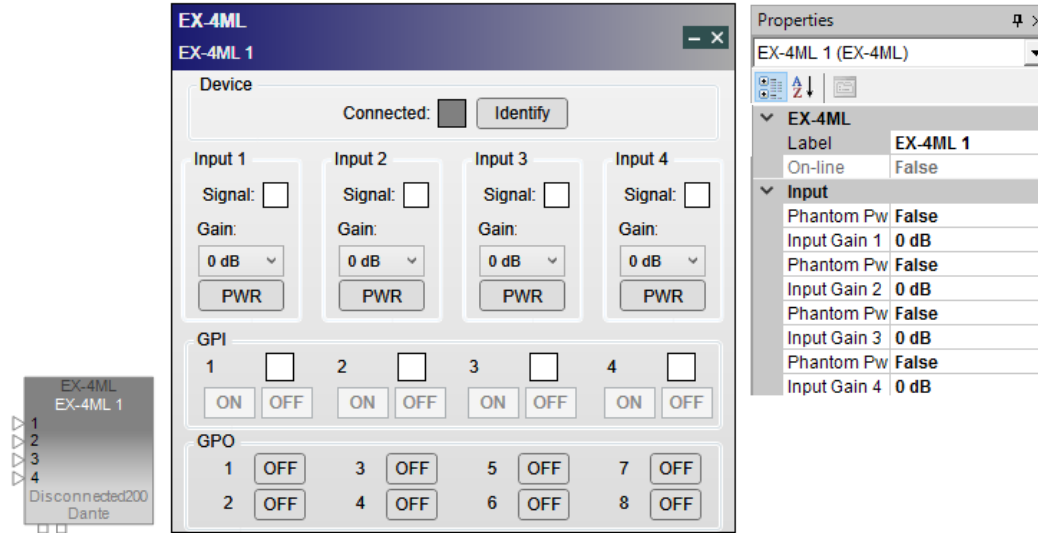

EX-4ML Off-line

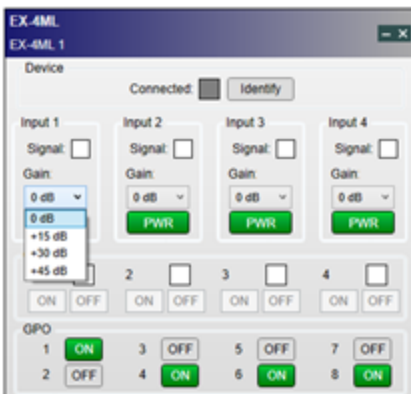

EX-4ML with PWR and GPO active

The control panel for the EX-4ML allows you to:

- Determine if the device is connected to the system. Blue = connected. **NOTE: The Connected control panel indicator conveys the Network connection status and not ControlSpace® Designer™ software On-Line status.**
- View audio input signal status.
- Set the coarse gain for any input from +0 dB to +45 dB.
- Apply Phantom Power to any channel via the PWR buttons.
- See the GPI output states for a given channel.
- Set or view the GPO input states.

The EX-4ML has four GP input control ports. When a GP input is active, the indicator next to its port number is lit.

The EX-4ML has eight GP output control ports. Click a button to set the state of an output to OFF (default) or ON before assigning the GPO processing block in Signal Processing View to a location in the **Project Directory** or **Parameter Set Nodes List**.

EX-8ML

The screenshot displays the EX-8ML control interface. At the top, a 'Device' section shows a 'Connected' status (grey) and an 'Identify' button. Below this are eight input channels, each with a 'Signal' indicator, a 'Gain' dropdown set to '0 dB', and a 'PWR' button. Underneath the inputs are eight GPI (General Purpose Input) buttons, each with an 'ON' and 'OFF' indicator. At the bottom are sixteen GPO (General Purpose Output) buttons, each with an 'ON' and 'OFF' indicator. A vertical list on the left shows the device name 'EX-8ML-0f65ce' and a 'Disconnected105 Dante' status. On the right, a 'Properties' window for 'EX-8ML 1 (EX-8ML)' lists various parameters: Label (EX-8ML 1), Identify (False), On-line (False), and a list of input parameters including Phantom Pw (False) and Input Gain (0 dB) for each of the eight channels.

EX-8ML Off-line

This screenshot shows the EX-8ML control panel in an 'Off-line' state. The 'Connected' indicator is grey. The gain dropdown for Input 1 is expanded, showing options: 0 dB, +15 dB, +30 dB, and +45 dB. The PWR buttons for inputs 5, 6, 7, and 8 are green. The GPI buttons for 1, 3, 5, and 7 are green (ON), while others are grey (OFF). The GPO buttons for 10, 12, 14, and 16 are green (ON), while others are grey (OFF).

EX-8ML with PWR and GPO active

The control panel for the EX-8ML allows you to:

- Determine if the device is connected to the system. Blue = connected.
- View audio input signal status.
- Set the coarse gain for any input from +0 dB to +45 dB.
- Apply Phantom Power to any channel via the PWR buttons.
- See the GPI output states for a given channel.
- Set or view the GPO input states.

The EX-8ML has eight GP input control ports. When a GP input is active, the indicator next to its port number is lit.

The EX-8ML has 16 GP output control ports. Click a button to set the state of an output to OFF (default) or ON before assigning the GPO processing block in Signal Processing View to a location in the [Project Directory](#) or [Parameter Set Nodes List](#).

EX-UH

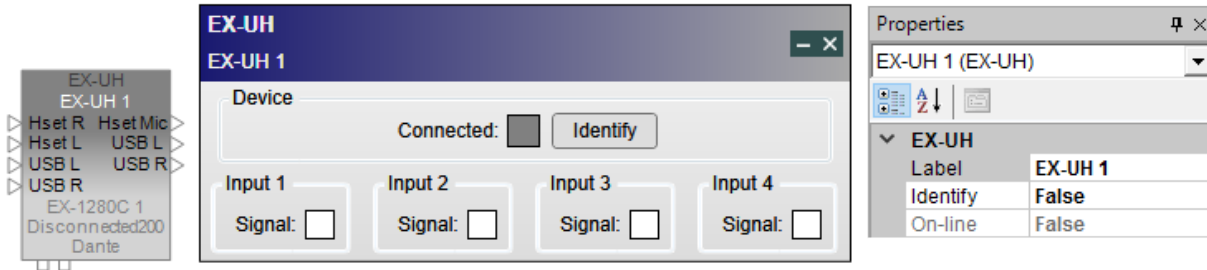

EX-UH Off-line

The control panel for the EX-UH allows you to:

- Determine if the device is connected to the system.
- View USB audio input signal status.

EP22-D

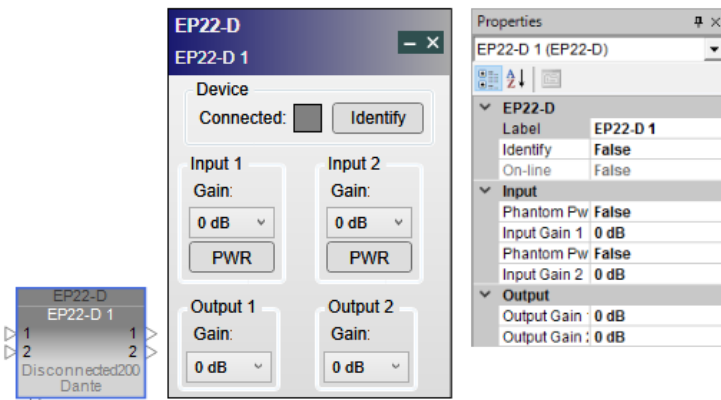

EP22-D Off-line

The control panel for the EP22-D allows you to:

- Determine if the device is connected to the system. Blue = connected.
- Set the coarse gain for any input or output. 0 dB, +25 dB, and +40 dB inputs. Output gain settings are 0 dB and +10 dB.
- Apply Phantom Power to any input channel via the PWR buttons.

EP40-D

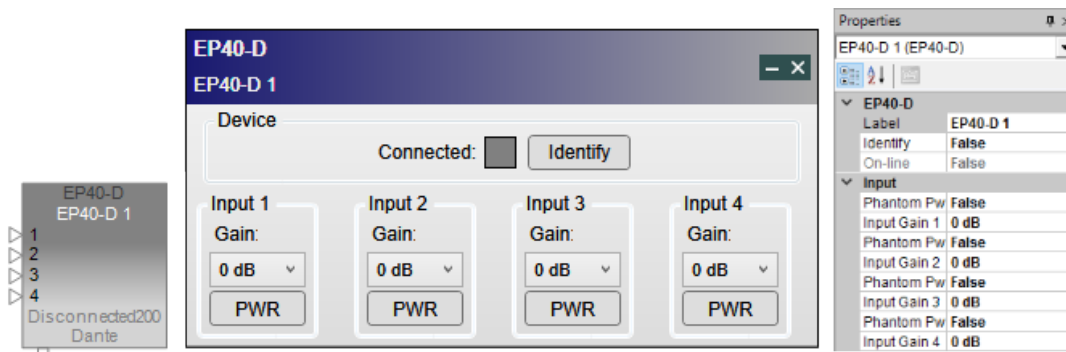

EP40-D Off-line

The control panel for the EP40-D allows you to:

- Determine if the device is connected to the system. Blue = connected.
- Set the coarse gain for any input from +0 dB to +45 dB.
- Apply Phantom Power to any input channel via the PWR buttons.

WP22B-D

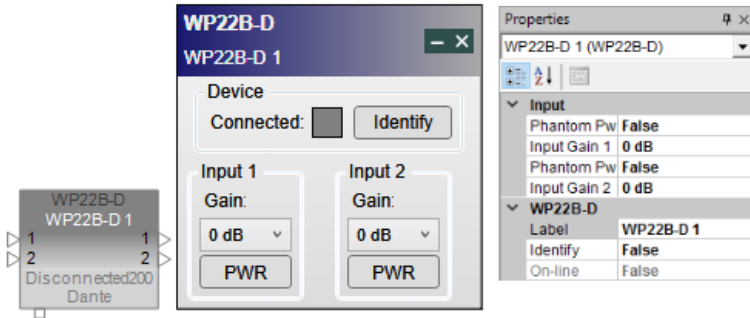

WP22B-D Off-line

The control panel for the WP22B-D allows you to:

- Determine if the device is connected to the system. Blue = connected.
- Set the coarse gain for any input to 0 dB, +25 dB, or +40 dB.
- Apply Phantom Power to any input channel via the PWR buttons.

WP22BU-D

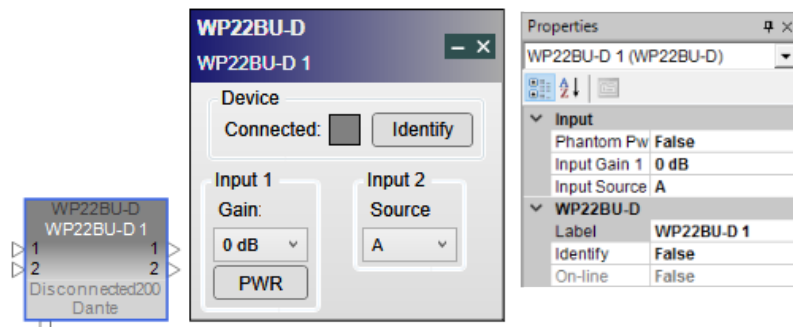

WP22BU-D Off-line

The control panel for the WP22B-D allows you to:

- Determine if the device is connected to the system. Blue = connected.
- Set the coarse gain for Input 1 to 0 dB, +25 dB, or +40 dB. Input 2 on the WP22BU-D allows you to select A, A+B, or B.
- Apply Phantom Power to any input channel via the PWR buttons.

MSA12X

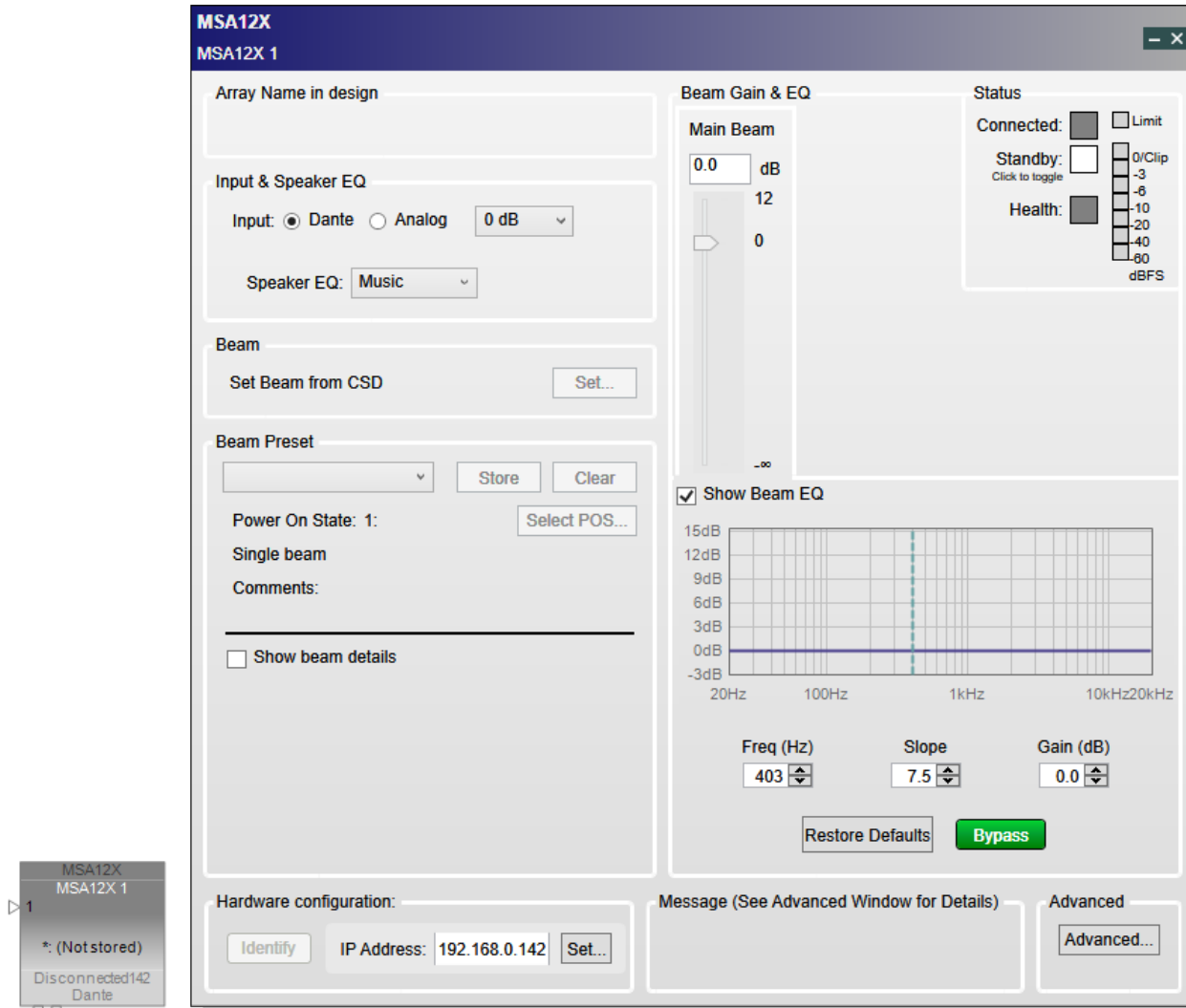

MSA12X Off-line

Basic control panel functions for the MSA12X include, but are not limited to:

- Determine if the device is connected to the system. Blue = connected.
- Select, display, and store speaker array beam presets.
- Display and adjust gain and equalization settings for a beam preset.
- Select an input source for the array: Dante network or analog audio.

For more information on the MSA12X main control panel, see "[MSA12X Configuration & Main Control Panel Options](#)" on page 402.

Right-Click Menu

A mouse right-click on any endpoint icon opens the same context menu.

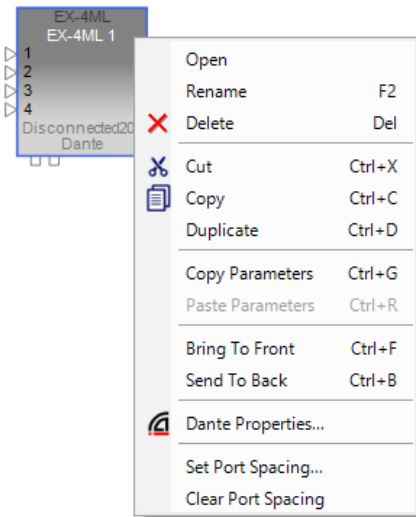

Right-click menu for Dante endpoint

Open displays the endpoint control panel.

Rename enables you to change the device name.

Delete removes the selected item from the Project View.

Cut deletes the selected item and copies it to the clipboard (standard Windows editing function).

Copy pastes a duplicate of the selected item to the clipboard (standard Windows editing function). All properties except name and state are copied. A unique name is assigned in keeping with the existing behavior for all other ControlSpace devices.

Duplicate copies *and* pastes the selected item, in effect cloning it (standard Windows editing function).

Copy Parameters copies the parameters, or settings, of the device. The parameters can be pasted to another device of the same type.

Paste Parameters pastes the copied settings from one or more devices of the same type.

Bring To Front moves selected item up over any overlapping objects.

Send To Back moves selected item behind any overlapping objects.

Dante Properties launches the Dante Properties control panel.

Set/Clear Port Spacing sets or clears the spacing between ports in the selected item.

After a device in a ControlSpace Designer project has been associated with a device on a Dante network, the option of **Break Association to Dante device** is added to the right-click menu. This allows you to disconnect the Dante endpoint device block from the actual hardware. After selecting this option, it will read **Associate with Dante Device**.

Device Icons/Controls for Dante-Equipped Microphone Endpoints

Dante-equipped microphones can be found in the Device List in the Dante Endpoints folder:

- ATND971 Audio-Technica Cardioid Condenser Boundary Microphone with Dante Output
- ATND8677 Audio-Technica Microphone Desk Stand with Dante Network Output
- ATND8734 Audio-Technica Wall/Ceiling Microphone with Dante Output
- MXA310 Shure Table Array Microphone with Dante Output
- MXA910 Shure Ceiling Array Microphone with Dante Output
- MXWAPT2 Shure Access Point Transceiver with 2-channel Dante output
- MXWAPT4 Shure Access Point Transceiver with 4-channel Dante output

- MXWAPT8 Shure Access Point Transceiver with 8-channel Dante output
- ULXD4D Shure Dual-Channel Digital Wireless Receiver
- ULXD4Q Shure Quad-Channel Digital Wireless Receiver

NOTE: For non-microphone Dante endpoints, see [Device Icons/Controls for Dante Endpoints](#).

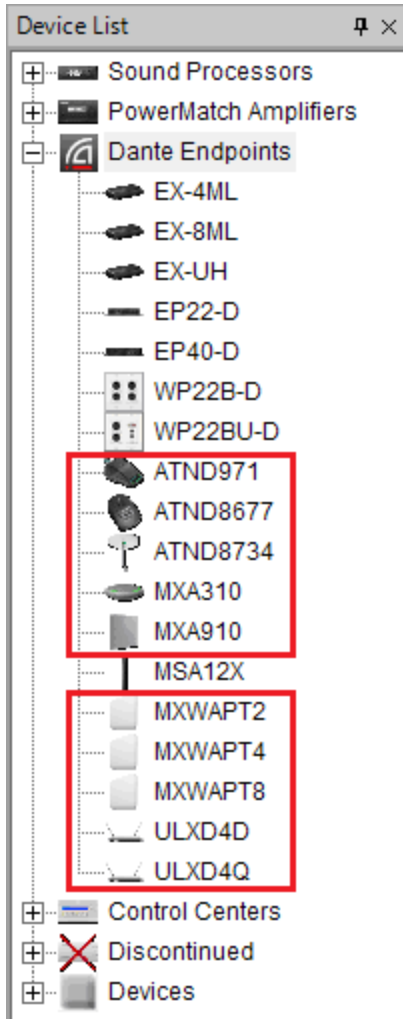

Dante-equipped microphones on Device List

The devices also appear as icons in Project view, once they are either automatically discovered on the network or manually dragged and dropped into Project View. Dante-equipped microphones have properties and a control panel that allows you to view and modify these properties. The Properties Window displays the list of properties and allows direct interaction for modifying their values.

NOTE: Each device's control panel has an **Identify** button. Clicking this button triggers a flashing Power/ID indicator on the device, which continues until reset.

ATND971

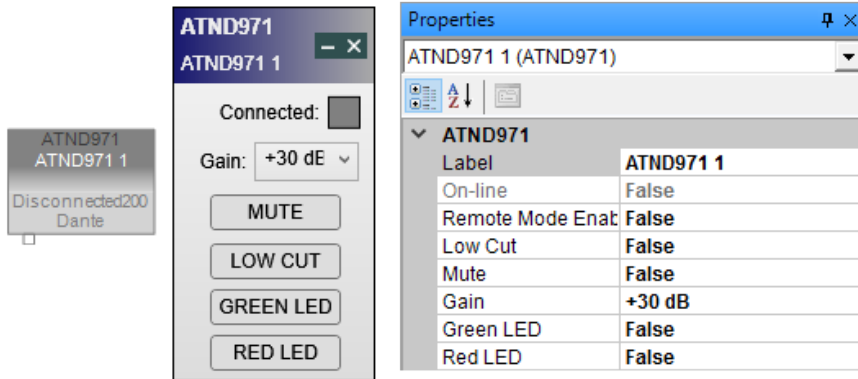

ATND971 Off-line

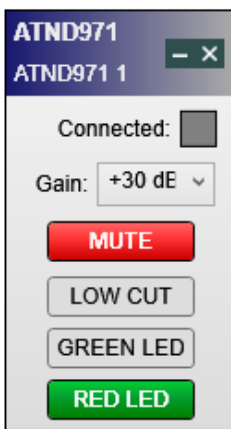

ATND971 with Mute and RED LED indicators on

The control panel for the ATND971 allows you to:

- Determine if the device is connected to the system. Blue = connected. **NOTE: The Connected control panel indicator provides Network connection status and not ControlSpace® Designer™ software On-Line status.**
- Set the coarse gain on the mic +30 dB, +40 dB or +50 dB.
- Mute or unmute the microphone.
- Enable or disable the microphone's Low Cut Filter.
- View or set the microphone's LED indicator states.

NOTE: The ATND971 does not retain any settings once disconnected from ControlSpace Designer software. Once disconnected, the mic gain is set to Mute (default). You can change mic settings only while the mic is online with ControlSpace Designer software.

ATND8677

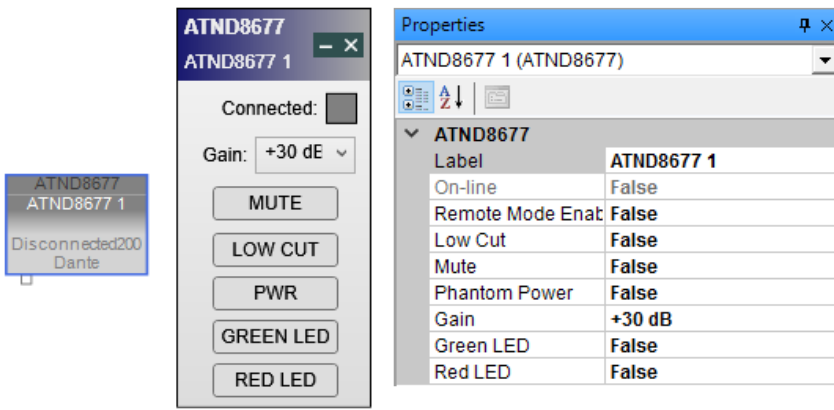

ATND8677 Off-line

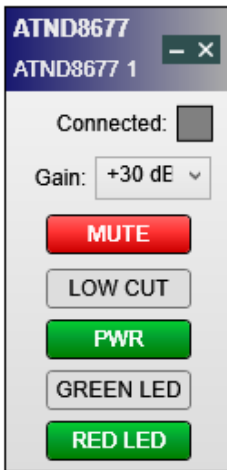

ATND8677 with Mute, PWR, and RED LED indicators on

The control panel for the ATND8677 allows you to:

- Determine if the device is connected to the system. Blue = connected.
- Set the coarse gain on the mic +30 dB, +40 dB or +50 dB.
- Mute or unmute the microphone.
- Enable or disable the microphone's Low Cut Filter.
- Apply Phantom Power via the PWR button.
- View or set the microphone's LED indicator states.

ATND8734

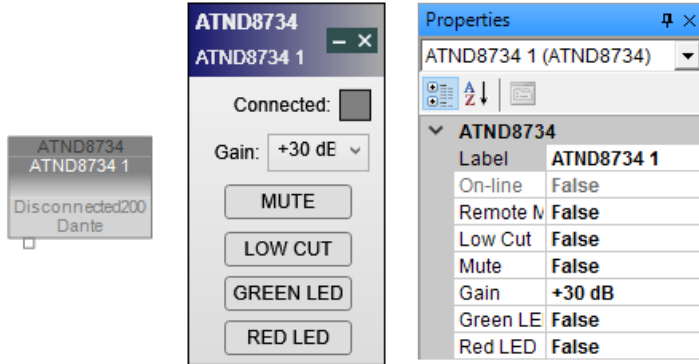

ATND8734 Off-line

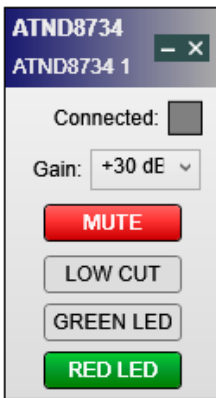

ATND8734 with Mute and RED LED indicators on

The control panel for the ATND8734 allows you to:

- Determine if the device is connected to the system. Blue = connected.
- Set the coarse gain on the mic +30 dB, +40 dB or +50 dB.
- Mute or unmute the microphone.
- Enable or disable the microphone's Low Cut Filter.
- View or set the microphone's LED indicator states.

MXA310

The screenshot displays the MXA310 control interface. At the top, there are sections for Dante and Shure Control connection status, both currently showing 'Connected' with grey indicators. The Shure Control IP is set to 192.168.0.1. Below this is a 'Device' section with buttons for 'Launch Web App', 'Identify', 'Mute', 'LED', and 'Load Preset'. Mute and unmute colors are set to RED and GREEN, respectively, with LED states set to ON. The main area features five vertical gain sliders for Channel 1, Channel 2, Channel 3, Channel 4, and AutoMix, each with a signal level indicator at 0.0 dB. A small floating window on the left shows 'MXA310 MXA310 1' and 'Disconnected200 Dante'. On the right, the Properties window for 'MXA310 1 (MXA310)' lists various parameters:

Input	
Device Mute	False
Preset	0
LED State	False
LED Segmen	False
LED Segmen	False
LED Segmen	False
LED Segmen	False
Input Gain 1	0.0
Input Gain 2	0.0
Input Gain 3	0.0
Input Gain 4	0.0
Input Gain 5	0.0
Misc	
Shure Contro	192.168.0.1
LED Mute Co	RED
LED Unmute	GREEN
LED Mute Sta	ON
LED Unmute	ON
MXA310	
Label	MXA310 1
Identify	False
On-line	False

MXA310 Off-line

The control panel for the MXA310 allows you to:

- Determine if the device is connected to the system. Blue = connected.
- Determine if the device is connected via the Shure Control Application.
- Set the Shure Control Device IP Address and connect to the application.
- Launch the Shure Web App.
- Mute or unmute the microphone.
- Enable and disable the MXA310 LEDs.
- Load device presets configured from the Shure Control Application.
- Set the LED colors for mute and unmute indication.
- Adjust each lobe's gain settings.
- Enable or disable each lobe's LED indicators.

MXA910

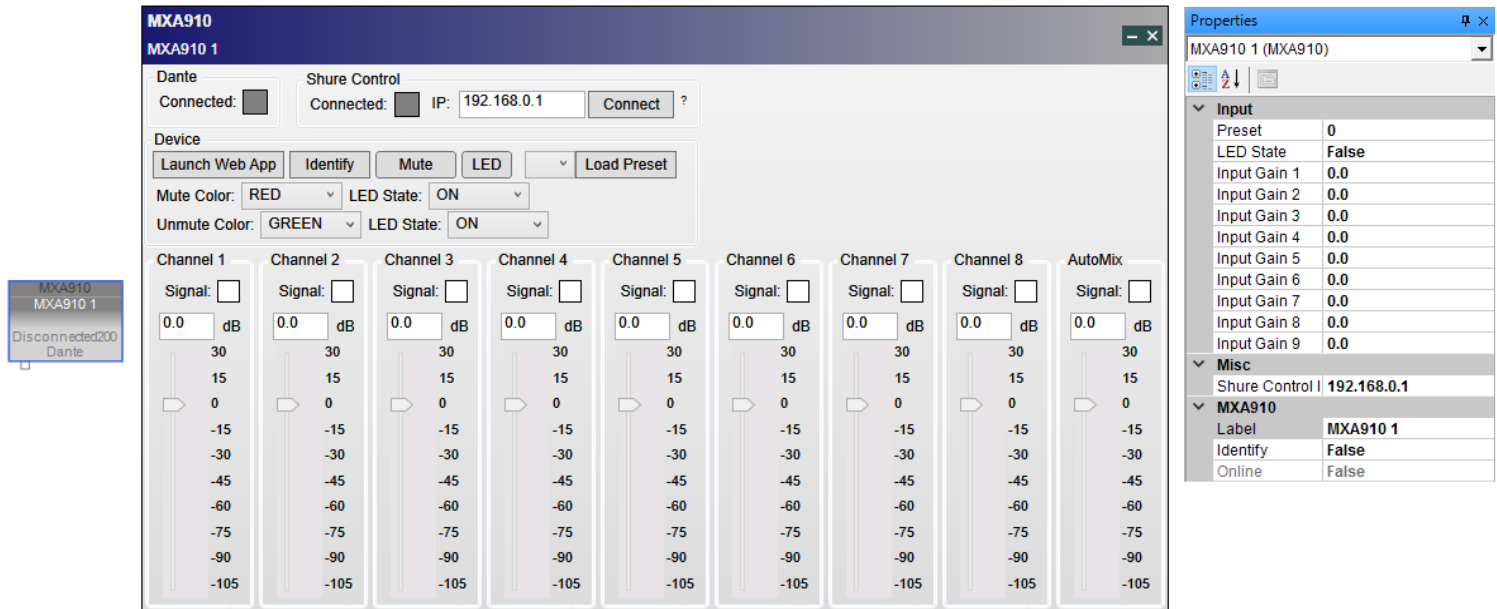

MXA910 Off-line

The control panel for the MXA910 allows you to:

- Determine if the device is connected to the system. Blue = connected.
- Determine if the device is connected via the Shure Control Application.
- Set the Shure Control Device IP Address and connect to the application.
- Launch the Shure Web App.
- Mute or unmute the microphone.
- Enable and disable the MXA910 LEDs.
- Load device presets configured from the Shure Control Application.
- Set the LED colors for mute and unmute indication.
- Adjust each lobe's gain settings.
- Enable or disable each lobe's LED indicators.

MXWAPT2, MXWAPT4, or MXWAPT8

Follow these steps to configure Shure MXWAPT2, MXWAPT4, or MXWAPT8 microphones to operate properly with ControlSpace Designer:

1. Connect the microphone hardware to the network.
2. Use the Shure device discovery utility to discover the MXW access point.
3. Apply a static IP address for **Network Audio** (Dante) and another one for **Control**. Both IP addresses must be within the range used in ControlSpace Designer configuration.
4. Double-click the **MXWAPT** block for the microphone in the design workspace to open it. Alternatively, right-click it and select **Open**, or click it and then press **Enter**.
5. In the window that appears, click the **+** next to **Transceiver** to expand the tab.
6. Enter the Control IP address into the **Control IP** field.
7. In the Shure microphone control software window, click the **Preferences** tab.

8. For the transmitter type of your microphone, set the **Switch Behavior** to one of the following:
 - a. **Toggle (default):** Press and release the microphone's button to switch its status between Active and Mute.
 - b. **Push-to-talk:** Press and hold the microphone's button to allow audio.
 - c. **Push-to-mute:** Press and hold the microphone's button to mute audio.
 - d. **Disabled:** The microphone's button will not affect the audio. This behavior is not recommended.
9. For the transmitter type of your microphone, set the **Initial State from Charger** (i.e., when the microphone is removed from the charger) to one of the following:
 - a. **Active:** The microphone will be on and pass audio to the network.
 - b. **Mute:** The microphone will be on, but the audio will be muted.
 - c. **Standby:** The microphone will be on but in a "sleep" state with audio muted.
 - d. **Off:** The microphone will be powered off.
10. For the transmitter type of your microphone, set the **Active/Mute LED Behavior** to **External LED Control**. The microphone's button and LED logic will be controlled by the DSP.
11. For each transmitter type, set the **Mute Preference** to **External Mute**. The microphone's mute switch will send a mute/unmute message to the DSP.
12. Apply any other settings, if required, and then close the window. All settings are effective immediately.

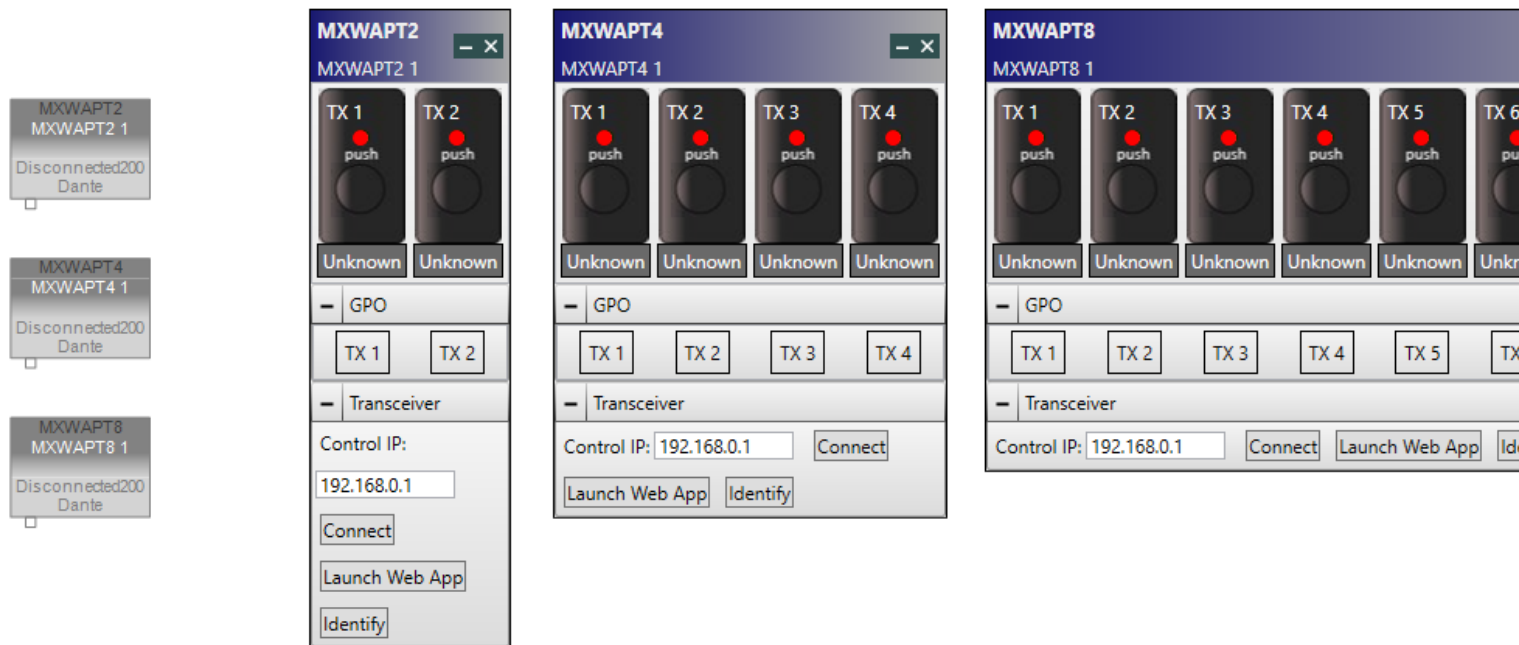

The control panel for the MXWAPT2, MXWAPT4, or MXWAPT8 allows you to:

- Set the microphone's Control IP address and connect to the application.
- View or set the state of each status LED.
- Change the state of each mute/active button when pressed or released.
- Open the Shure control software application.

ULXD4D

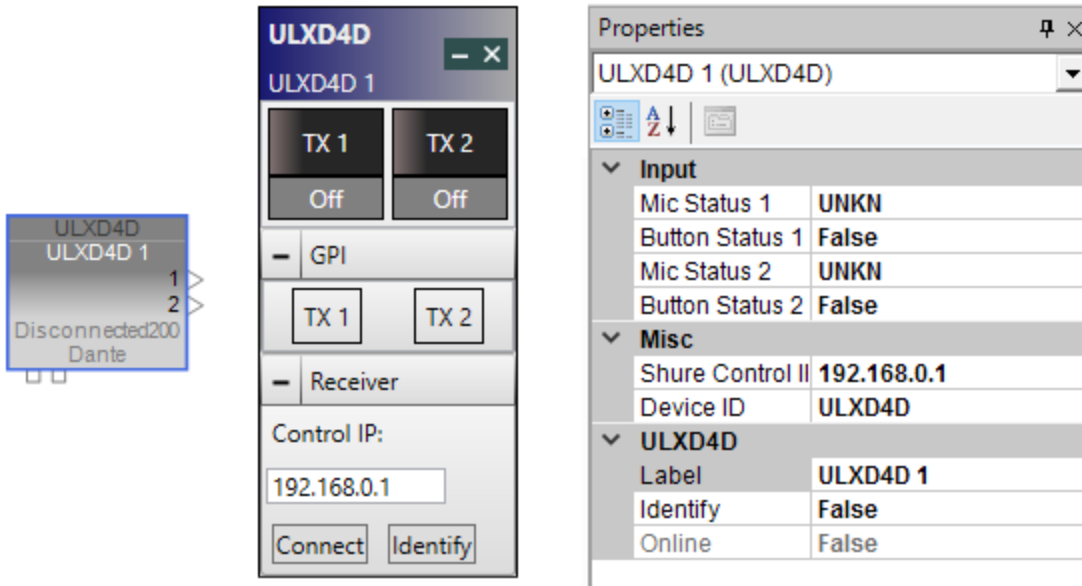

The control panel for the ULXD4D allows you to:

- Set the microphone's Control IP address and connect to the application.
- View or set the state of each button.

ULXD4Q

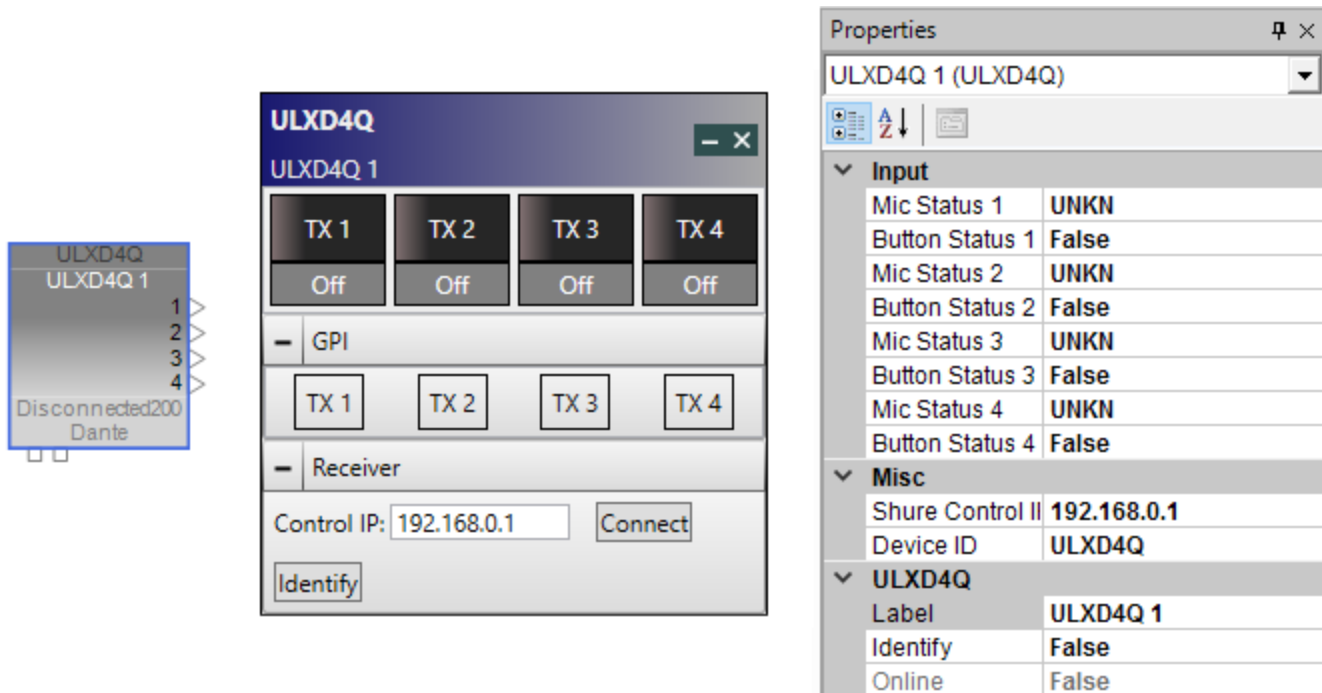

The control panel for the ULXD4Q allows you to:

- Set the microphone's Control IP address and connect to the application.
- View or set the state of each button.

Right-Click Menu

A mouse right-click on any Dante-equipped mic icon opens the same context menu.

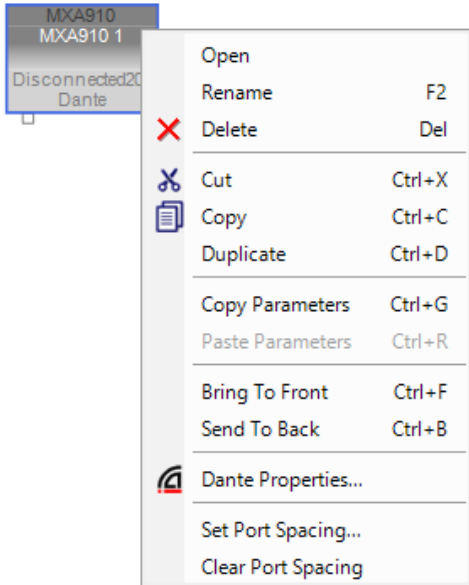

Open displays the endpoint control panel.

Rename enables you to change the device name.

Delete removes the selected item from the Project View.

Cut deletes the selected item and copies it to the clipboard (standard Windows editing function).

Copy pastes a duplicate of the selected item to the clipboard (standard Windows editing function). All properties except name and state are copied. A unique name is assigned in keeping with the existing behavior for all other ControlSpace devices.

Duplicate copies *and* pastes the selected item, in effect cloning it (standard Windows editing function).

Copy Parameters copies the parameters, or settings, of the device. The parameters can be pasted to another device of the same type.

Paste Parameters pastes the copied settings from one or more devices of the same type.

Bring To Front moves selected item up over any overlapping objects.

Send To Back moves selected item behind any overlapping objects.

Dante Properties launches the Dante properties window.

Set/Clear Port Spacing sets or clears the spacing between ports in the selected item.

After a device in a ControlSpace Designer project has been associated with a device on a Dante network, the option of **Break Association to Dante device** is added to the right-click menu. This allows you to disconnect the Dante mic device block from the actual hardware. After selecting this option, it will read **Associate with Dante Device**.

Adding Dante Endpoint and Microphone Blocks to SP View

Any Dante endpoints and Dante microphone devices that have been added to Project View will automatically be listed in the SP Tool Kit for all connected signal processors (see [Adding Dante Endpoints and Microphones to Project View](#) for more on adding Dante devices).

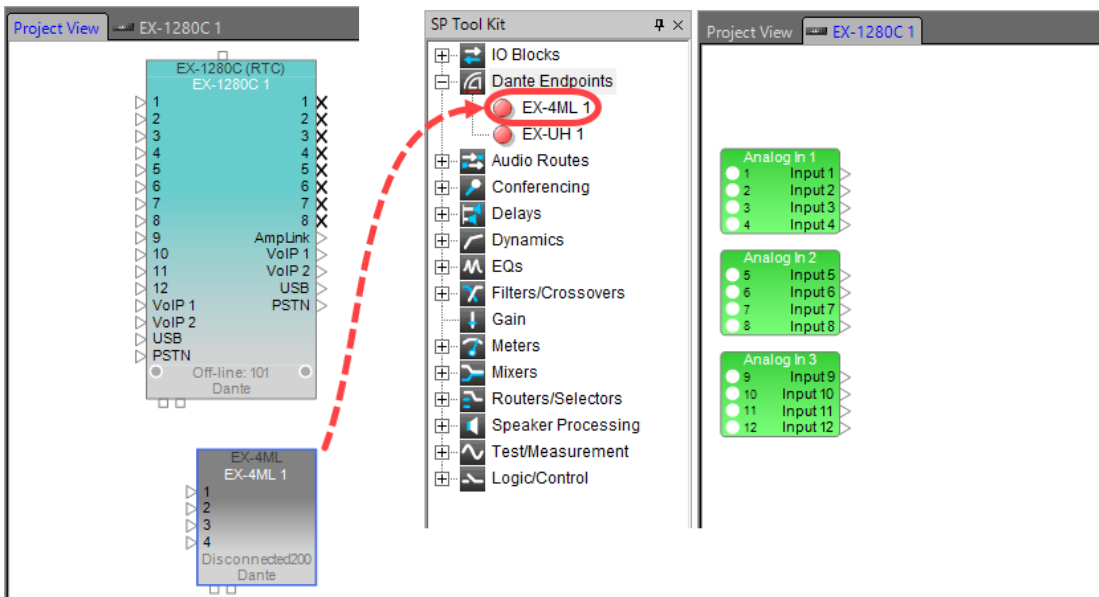

Dante endpoint as it appears in SP Tool Kit

To add a Dante endpoint or Dante microphone block to the Signal Processing View of a particular signal processor, locate the Dante Endpoint or Dante Microphone in the Dante Endpoints section of the SP Tool Kit and drag it into Signal Processing View.

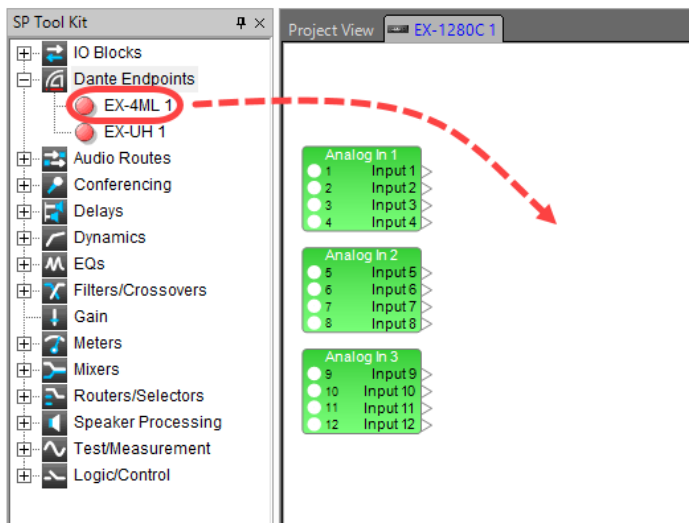

Dragging Dante endpoint or mic into Signal Processing View

When a Dante endpoint or Dante microphone block is dragged into Signal Processing View, it is now automatically associated with that signal processor. Therefore, the Dante block is no longer listed in the SP Tool Kit. The Dante SP block is added, along with a GPO and GPI block if the device supports it. Most, but not all, Dante SP blocks have companion GPI or GPO blocks.

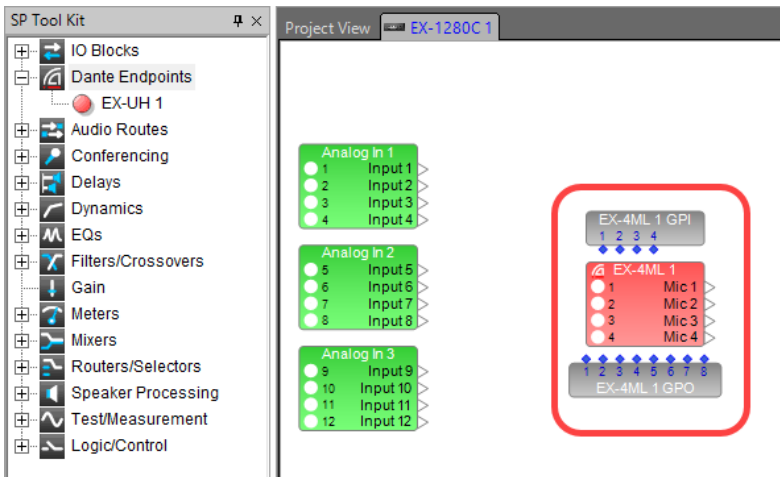

Dante endpoint signal processing blocks

For a description of Dante SP and GPI/GPO blocks, see [Dante Endpoint and Microphone SP Blocks](#).

NOTE: To make the Dante endpoint or mic available in the SP Tool Kit again, simply delete the Dante endpoint or mic icon from Signal Processing View.

Dante Endpoint and Microphone SP Blocks

This topic describes the SP blocks that display in Signal Processing View for each Dante UTB endpoint and microphone. Most but not all Dante SP blocks have companion GPI or GPO blocks.

- The GPI/GPO control panel that displays when you double-click a GPI or GPO block is the same as that for the Dante device block, described in [Device Icons/Controls for Dante Endpoints](#) and [Device Icons/Controls for Dante-Equipped Microphone Endpoints](#).
- The Dante Rx audio block control panel that displays when you double-click the Dante Rx block is the same as the input control panel for the Dante I/O block, described in [EX-1280C Dante™ Input/Outputs](#). However, the labels for Dante Rx channels may vary, depending on the model of the Dante endpoint or microphone.
- The Dante Tx audio block control panel that displays when you double-click the Dante Tx block is the same as the output control panel for the Dante I/O block, described in [EX-1280C Dante™ Input/Outputs](#). However, the labels for Dante Tx channels may vary, depending on the model of the Dante endpoint or microphone. Only the EX-UH and MSA12X endpoints have a Dante Tx block.

NOTE: For more information on third-party Dante product terminology referenced in this topic, consult the vendor's product documentation.

EX-4ML

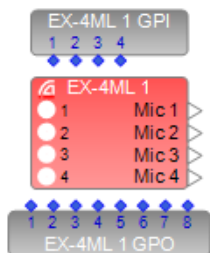

The EX-4ML SP block consists of a:

- Dante Rx audio block
- Logic eight-port GPO block
- Logic four-port GPI block

EX-8ML

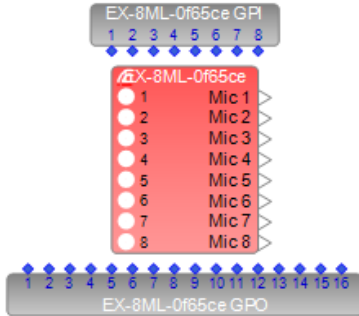

The EX-8ML SP block consists of a:

- Dante Rx audio block
- Logic 16-port GPO block
- Logic eight-port GPI block

EX-UH

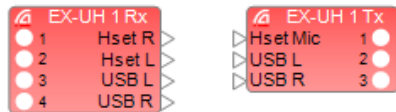

The EX-UH SP block consists of a:

- Dante USB Rx audio block
- Dante USB Tx audio block

ATND971

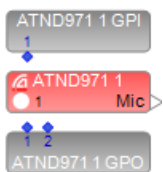

The ATND971 microphone SP block consists of a:

- Dante Rx audio block
- Two-port Logic GPO block (LED indicators)
- One-port Logic GPI block (pushbutton)

ATND8677

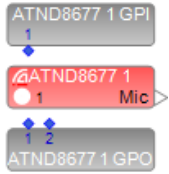

The ATND8677 microphone SP block consists of a:

- Dante Rx audio block
- Two-port Logic GPO block (LED indicators)
- One-port Logic GPI block (pushbutton)

ATND8734

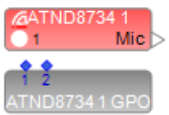

The ATND8734 microphone SP block consists of a:

- Dante Rx audio block
- Two-port Logic GPO block (LED indicators)

MXA310

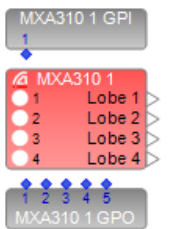

The MXA310 microphone SP block consists of a:

- Dante Rx audio block
- Five-port Logic GPO block (LED indicators)
- One-port Logic GPI block (pushbutton)

MXA910



The MXA910 microphone SP block consists of a:

- Dante Rx audio block
- One-port Logic GPO block (LED indicator)

MSA12X

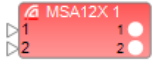

The MSA12X SP block consists of a Dante Tx audio block.

MXWAPT2

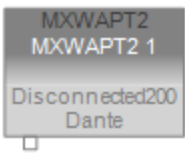

The MXWAPT2 microphone SP block consists of a:

- Two-channel Dante Rx audio block
- Two-port Logic GPO block (LED indicator)
- Two-port Logic GPI block (pushbutton)

IMPORTANT: You must use the Shure control software to configure this microphone to work properly in ControlSpace Designer. See [Device Icons/Controls for Dante-Equipped Microphone Endpoints](#) to learn how to do this.

MXWAPT4



The MXWAPT4 microphone SP block consists of a:

- Four-channel Dante Rx audio block
- Four-port Logic GPO block (LED indicator)
- Four-port Logic GPI block (pushbutton)

IMPORTANT: You must use the Shure control software to configure this microphone to work properly in ControlSpace Designer. See [Device Icons/Controls for Dante-Equipped Microphone Endpoints](#) to learn how to do this.

MXWAPT8



The MXWAPT8 microphone SP block consists of a:

- Eight-channel Dante Rx audio block
- Eight-port Logic GPO block (LED indicator)
- Eight-port Logic GPI block (pushbutton)

IMPORTANT: You must use the Shure control software to configure this microphone to work properly in ControlSpace Designer. See [Device Icons/Controls for Dante-Equipped Microphone Endpoints](#) to learn how to do this.

ULXD4D

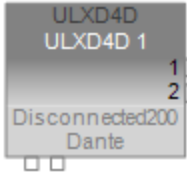

The ULXD4D microphone SP block consists of a:

- Two-channel Dante Rx audio block
- Two-port Logic GPI block (pushbutton)

ULXD4Q

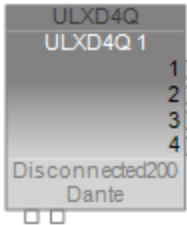

The ULXD4Q microphone SP block consists of a:

- Four-channel Dante Rx audio block
- Four-port Logic GPI block (pushbutton)

MSA12X Steerable Loudspeaker Array Dante Endpoint

About the MSA12X Steerable Loudspeaker Array

The Panaray® MSA12X modular steerable loudspeaker array features 12 full-range 2.25-inch transducers (with 75 Hz – 14 kHz response) per module in a columnar line array configuration. Each module includes 12 internal drivers (50 watts per channel; total 600-watt rated power) and an onboard DSP to provide digital control and beam steering of array vertical coverage patterns. Up to three MSA12X modules can be stacked in a single array to increase coverage distance and low-frequency pattern control.

Independent level and EQ control is supported for up to two separate beams per array, and the onboard memory stores up to 10 user-selectable beam presets. The MSA12X features both Dante™ network connectivity and line-level analog input.

As with any Dante endpoint, the MSA12X device block appears as an icon in Project View, once it is either automatically discovered on the network or manually dragged and dropped into Project View. These devices have properties and a control panel that allows you to view and modify these properties.

NOTE: For ESP-880,1240, 4120, and 1600 sound processors, a Dante network card is required for dual-beam functionality and for parameter set support for beam presets.

For more general information on adding Dante endpoints and accessing their control panels, see:

[Device Icons/Controls for Dante Endpoints](#)

[Dante Endpoint and Microphone SP Blocks](#)

[Adding Dante Endpoints and Microphones to Project View](#)

[Adding Dante Endpoint and Microphone Blocks to SP View](#)

For more information on the MSA12X control panels and configuration options, see:

[MSA12X Configuration & Main Control Panel Options](#)

[Storing and Recalling Beam Presets in MSA12X Arrays](#)

[Setting an MSA12X Array's Power-On State](#)

[Setting Up MSA12X Basic Beam Steering and Spreading in CSD](#)

[MSA12X Advanced Control Panel Options](#)

[Assigning MSA12X Beam Presets to Parameter Sets](#)

MSA12X Configuration & Main Control Panel Options

This topic describes basic MSA12X configuration and control panel options. For a more comprehensive, step-by-step description of design workflow and best practices, see the *MSA12X Design Guide*.

Acquiring Beam Configuration Data

There are two ways to get MSA12X array beam configuration data into CSD and the arrays:

- Import the data from Bose Modeler software. **NOTE: See the online help within *Bose Modeler software* for more information on how to send data to CSD.**
- Set up basic steering and spreading parameters for an array in the MSA12X control panel. This option is primarily although not exclusively for users who do not have or choose not to use Bose Modeler software. See [Setting Up MSA12X Basic Beam Steering and Spreading in CSD](#) for more information.

If you are importing the data from Modeler, the following dialog appears in CSD when you first send the data from Modeler:

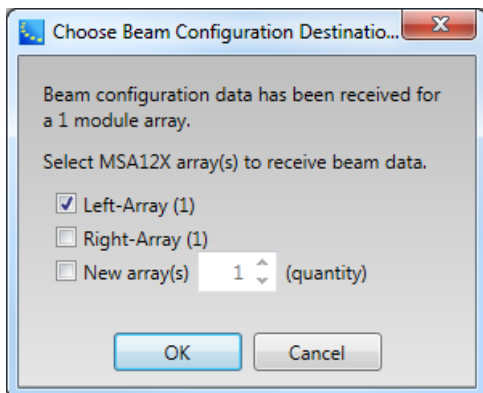

Choose Beam Configuration Destination dialog - example

If there is an existing MSA12X array device block in Project View that is not designated as a destination of beam data from Modeler and the number of modules in that device block either matches the beam data from Modeler or is not specified yet, that device block is listed in the dialog. If there are any existing MSA12X array device block(s) that have already been designated as destinations for beam data from

Modeler, they are shown with a check mark. A number in parentheses indicates the number of modules in the array.

Select the array or arrays to which you want to send the beam configuration data and click **OK**. The control panel for the array populates with the new settings, including the number of modules in the array, number of beams (single or dual), beam shape data, and comments entered in Modeler.

NOTE: If there are no array device blocks with a matching number of modules or you want to send the beam data to new array blocks, you can select **New Array(s)** and specify the number of arrays to add. The new array device blocks with the beam configuration data are then created and added to Project View.

Once you have made an association between an MSA12X array device block and the hardware, any subsequent beam changes that you send to CSD will be automatically incorporated in the array control panel and sent automatically to the hardware (no Choose Beam Configuration Destination dialog is shown). However, if you want to force the dialog to *a/ways* display for any MSA12X array device blocks when sending data from Modeler, right-click on any one of the array device blocks and select **Always show Beam Config Destination Window**. **NOTE:** This is a global setting that affects all MSA12X array device blocks. You may not use this option selectively on one array device block.

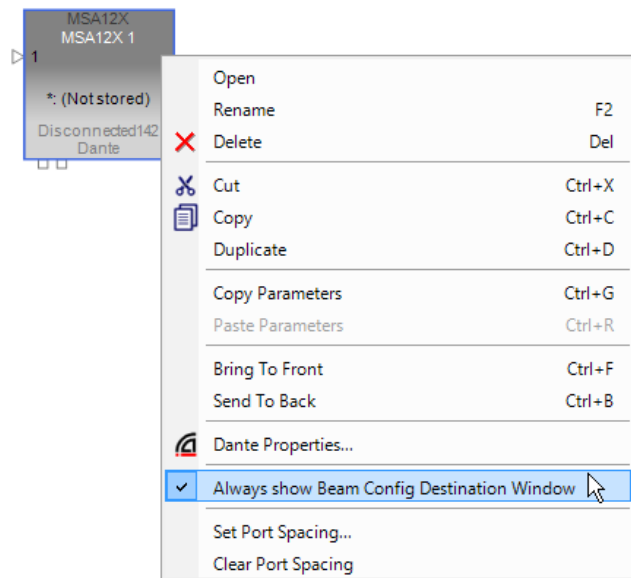

Always show Beam Config Destination Window enabled

MSA12X Device Block

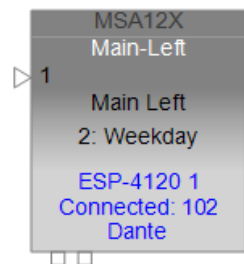

MSA12X device block - example

An MSA12X device block contains the following information, listed from top to bottom:

- Device name (MSA12X).
- MSA12X array name (Main-Left in example). This is blank if not set yet.
- Name of current beam preset (2:Weekday in example).

- Device name of sound processor associated with the MSA12X array (ESP 4120 1 in example). This is blank if there is no current association.
- Connection status between CSD and the MSA12X (Connected or Disconnected).
- Last octet of IP address of MSA12X array (102 in example).
- Input audio type (Dante or Analog).

MSA12X Main Control Panel

Double-click an MSA12X device block in Project View to open its main control panel.

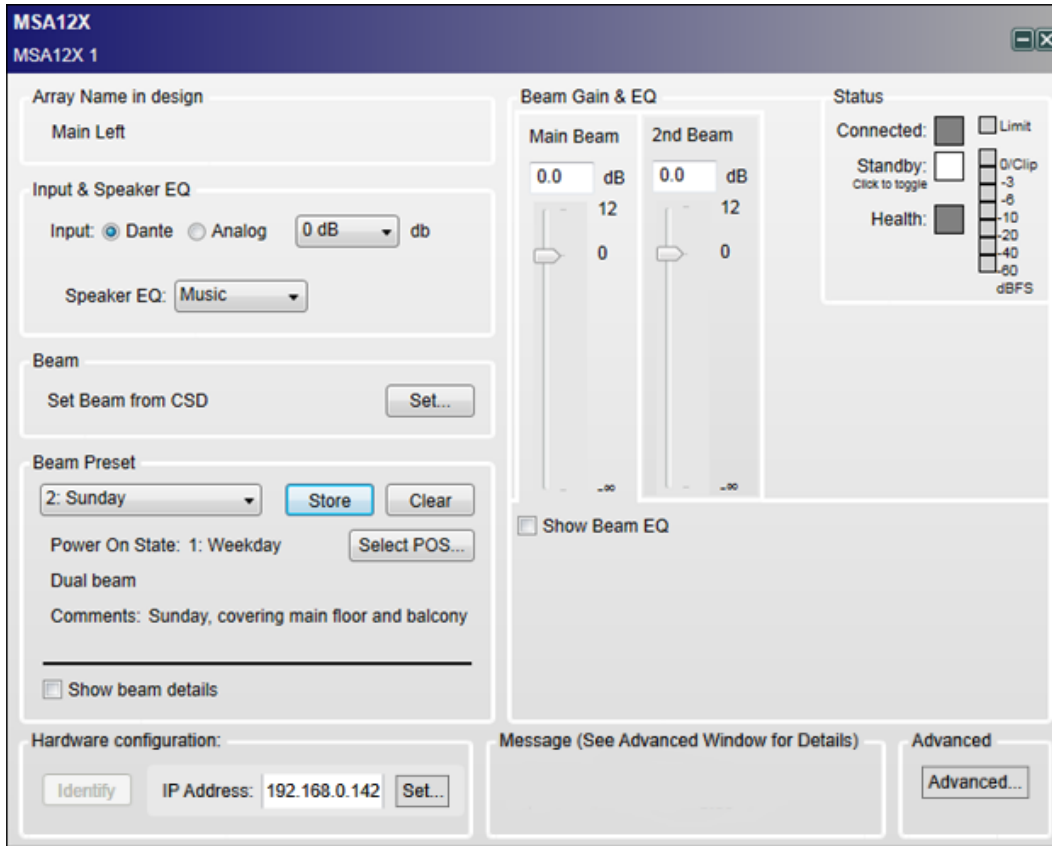

MSA12X main control panel

IMPORTANT: Endpoint control must be enabled to make changes to most options in the control panel. To enable endpoint control, select System > Enable Endpoint Control in the CSD menu bar.

The main control panel provides the following options for the selected array:

Array name in design - array name as specified in Modeler. If no name is defined, this is blank. **NOTE:** You can only define array names in Modeler, not in CSD. The array name in the design can be different than the Dante device name for the array.

Input & Speaker EQ

Input - can select the input type, either digital Dante audio or an analog signal for the input. Can apply a fixed gain level to the input audio of 0, +14, or +24dB.

Speaker EQ - can specify a fixed EQ, optimized for either Music or Voice. The beam EQ can be adjusted further using the Beam Gain & EQ option.

Beam

Set Beam from CSD - sets basic beam steering and spreading parameters from CSD. For more information, see [Setting Up MSA12X Basic Beam Steering and Spreading in CSD](#).

Beam Preset - use the options in this section to store, recall, or view information for a beam preset (see [Storing and Recalling Beam Presets in MSA12X Arrays](#)) or to specify a power-on state for the array (see [Setting an MSA12X Array's Power-On State](#)). The number of beams and any comments are displayed in the Beam Preset section whenever beam settings are imported from Modeler, stored to a beam preset, or recalled.

Show Beam Details - select to display more detailed information from either Modeler or CSD for the main and second beam (if any) in the array. Includes number of modules, beam type, beam setting parameters such as steering and spreading angles, whether vocal range smoothing is enabled, array pitch, and other information.

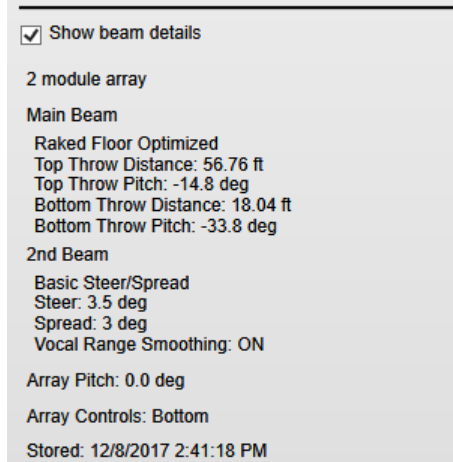

MSA12X main control panel - Show Beam Details option

Hardware Configuration

Identify - if Dante control is enabled and the array is online, this button causes an LED to blink repeatedly on the rear of the array. Useful for identifying which array is being controlled.

IP Address - IP address assigned to the array. This is for information only and cannot be modified here.

Set... - displays the Dante Properties window. You can modify Dante routing, IP address assignment, and other Dante configuration information for the array. See [Dante™ Network Device Properties](#).

Beam Gain & EQ - click the Main Beam or 2nd Beam gain panel to display/modify the EQ curve for the respective beam.

Main Beam - can adjust the gain slider for the main beam from $-\infty$ to +12dB, or type in the value directly. **NOTE: You may not assign gains for either beam to a ControlSpace controller, such as a CC-64, or to custom controls created in ControlSpace Remote Builder. See the [MSA12X Design Guide](#) for more information.**

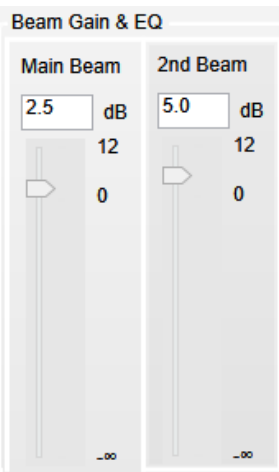

MSA12X main control panel - Beam Gain adjustment

2nd Beam - can adjust the gain slider for the second beam (if any) from $-\infty$ to +12dB, or type in the value directly.

Show Beam EQ - when selected, displays the EQ curve for the selected beam gain panel. Beam EQ is a filter to compensate the tonal balance change depending on the type and parameters of beam spreading.

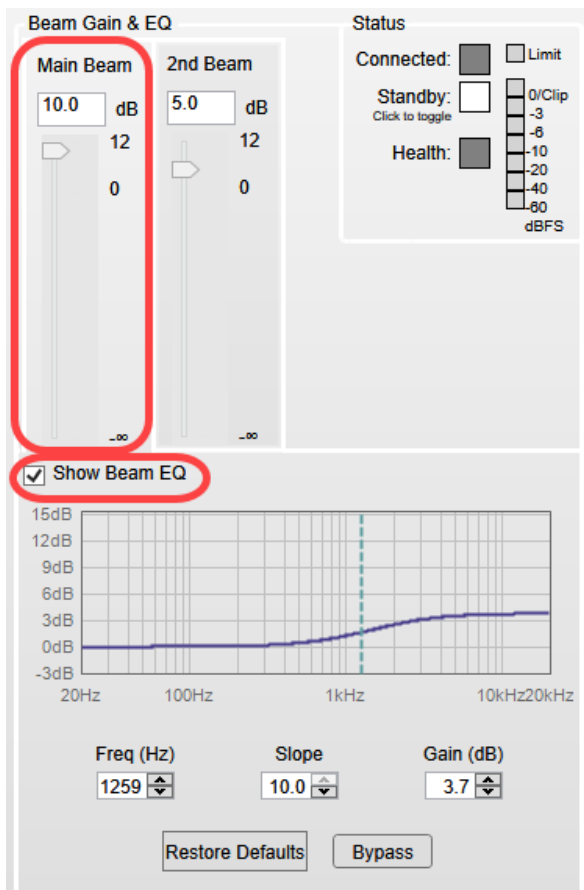

MSA12X main control panel - Beam EQ adjustment (Main beam selected)

For beam data provided either by Modeler or CSD (with the **Set Beam from CSD** function), the beam EQ curve is automatically calculated each time the data is sent to CSD. You can adjust the following EQ parameters with the arrow controls or type them in directly:

Freq (Hz) - center frequency in Hz. Range: 100-4000.

Slope - slope of the curve. Range: 0.0-10.0.

Gain (dB) - high-boost gain in dB. Range: -2 to +12.

Restore Defaults - return to beam EQ settings calculated for the beam pattern.

Bypass - click to ignore (bypass) the beam EQ settings.

Status

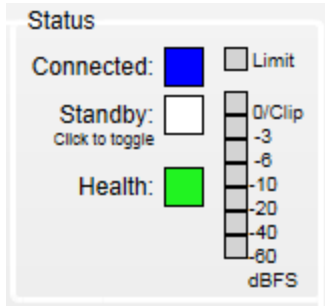

MSA12X main control panel - Status options

Connected - when illuminated blue, indicates an active connection between CSD and the array.

Standby - select to manually enable/disable Standby (low or idle power) mode for the array. Can be used to reduce power consumption. When enabled, the box turns red. Default: Disabled (normal power mode). **NOTE: Alternatively, you can enable Standby mode automatically with the Auto-Standby option in the MSA12X advanced control panel.**

Health - a color that reflects the operational health of the array

Green - no warnings or errors.

Yellow - temperature warning in one or more modules in the array.

Red - either a temperature fault in the array is severe enough to cause shutdown or there is an existing error condition, e.g. beam preset mismatch error.

Level meter - displays signal level after the input gain. A Clip level (over 0 dBFS) indicates when the array is being overdriven.

Limit - if the Clip level is persistent, the array automatically limits the signal level and the Limit indicator turns yellow.

Advanced - accesses the MSA12X advanced control panel.

Storing and Recalling Beam Presets in MSA12X Arrays

Whenever you send beam configuration data from Modeler to one or more MSA12X array device blocks in CSD, that data and any other settings in the control panel become the active configuration for those blocks and their associated array hardware. However, if you power cycle the array(s), the data will be lost unless you first store it to a beam preset, which is a snapshot of the current settings. Each beam preset includes the following parameters:

- Input audio type - Dante or analog
- Speaker EQ type - Music or Voice
- **Beam parameters** - any beam configuration settings contained in the Modeler MDR file (or basic steering/spread angles set in CSD)
- Comments - any comments entered in the Modeler MDR file or edited in CSD and stored in the beam preset
- Beam Gains - beam gain settings for the main and second beam (if any)
- Beam EQs - beam EQ settings for the main and second beam (if any)

You can store these settings in a new beam preset or update an existing beam preset. You can store and recall up to ten beam presets per array.

To store the current settings in a new beam preset:

1. In the Beam Preset section of the main MSA12X control panel, click **Store**.
2. In the Store Beam Preset dialog, select the beam preset where you want to store the settings from the Beam Preset drop-down list. For a new preset, the preset ID is a number with no name (1, in the example below).

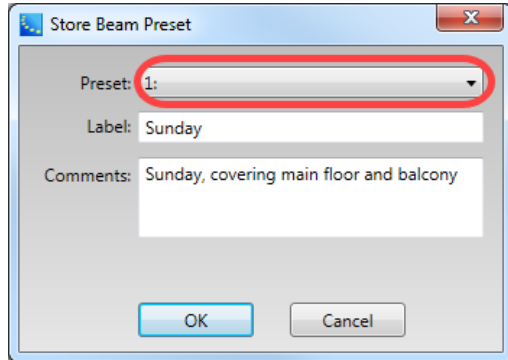

Store Beam Preset dialog

3. In the Label box, enter the name for the beam preset.
4. The Comments box displays any comments that were entered in the Modeler MDR file for the array or modified later in CSD. You can add to or edit the comments (maximum, 50 characters).
5. Click **OK** to store the beam preset.

The beam preset name from the Label field now appears next to its number. The number of beams and any comments are also displayed.

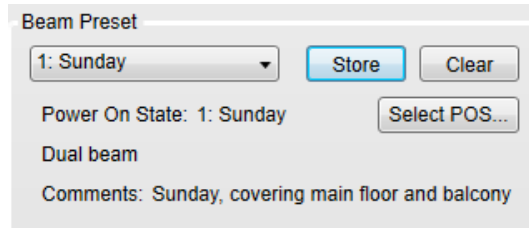

NOTE: If you change any setting in the control panel while a beam preset is selected, the Beam Preset drop-down list will become blank. This means that the settings have changed and you will need to store them to a beam preset in order to retain them.

To update an existing preset with the current settings:

1. In the Beam Preset section of the main MSA12X control panel, click **Store**.
2. In the Store Beam Preset dialog, select the name of the existing beam preset from the Beam Preset drop-down list.
3. Add or edit the comments if needed and click **OK**.
4. In the Overwrite Preset dialog, verify that you want to replace the current preset settings on the right with the new settings on the left. Note that only beam parameter changes and not necessarily all changes to the control panel settings that comprise a beam preset are listed.

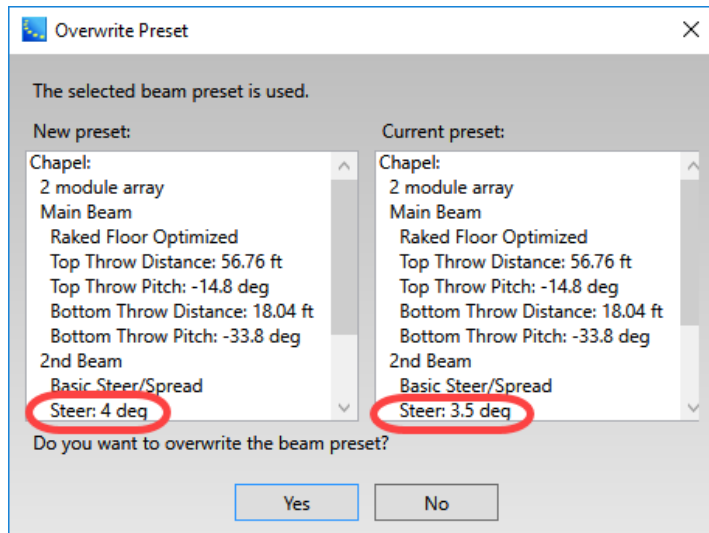

Overwrite Preset dialog

- Click **Yes** to apply the changes to the beam preset.

To recall a stored beam preset and display its settings in the control panel, select it from the Beam Preset drop-down list in the main MSA12X control panel.

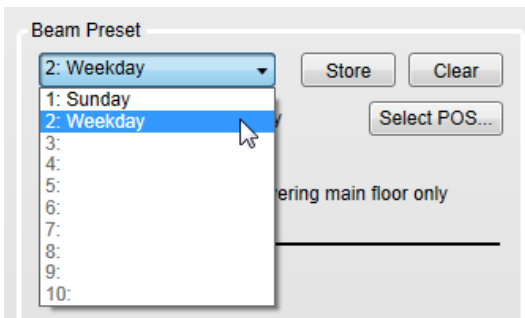

Recalling a stored beam preset

To delete a beam preset, select it from the Beam Preset drop-down list and click **Clear**.

NOTE: You may not use this method to delete a beam preset that is designated as the power-on preset when the array is power cycled (see [Setting an MSA12X Array's Power-On State](#)). To remove the power-on preset and all other presets from the array, click **Reset to Defaults** in the **"MSA12X Advanced Control Panel Options"** on page 411.

Setting an MSA12X Array's Power-On State

By default, the first beam preset listed in the Beam Preset drop-down list in the main MSA12X control panel is automatically loaded when you power cycle the array. However, you can change the preset that is loaded when you power up the array.

To set the beam preset that is loaded when array is power cycled:

- In the Beam Preset section of the main MSA12X control panel, click **Select POS...**
- In the Select Power On State dialog, select the beam preset from the drop-down list that you want to load when the array powers on.

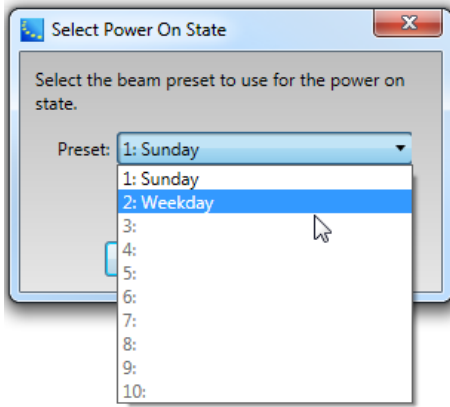

Selecting beam preset for power-on state

3. Click **OK**. The Power On State field now lists the designated power-on beam preset's name.

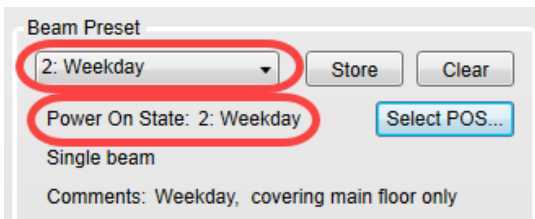

Power-on state beam preset selected

Setting Up MSA12X Basic Beam Steering and Spreading in CSD

If you do not use Bose Modeler software, you can use CSD to set up basic beam steering and spreading angles for an array.

You can use this function *only* to set basic steering and spreading angles for an array. If your room requires a different beam type, vocal range smoothing, or additional parameters, you must use Modeler software to configure and then import the settings.

The angular ranges for basic steering and spreading are the same as those in Modeler. They are:

Basic Steering/Spreading Angle Limits for MSA12X

	1 module array	2 module array	3 module array
Steering angle	-20 to +20°	-20 to +20°	-20 to +20°
Spreading angle	0 to +30°	0 to +40°	0 to +40°

Note that this function is only available when the MSA12X device block in CSD is associated with a physical MSA12X array OR the MSA12X device block has already received beam configuration data from Modeler.

To set basic beam steering and spreading from CSD:

1. In the Beam section of the main MSA12X control panel, click **Set....**

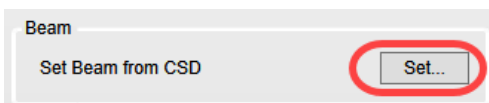

2. In the Beam Control dialog, adjust the Steer and Spread angle values for the main and secondary beams using the arrow controls, or type them in directly.

The red wire frame represents the main beam and the blue wire frame the secondary beam. The angles of these wire frames visually change as you make adjustments. To view the secondary beam wire frame or to access the secondary beam angle controls, you must select the Enable option.

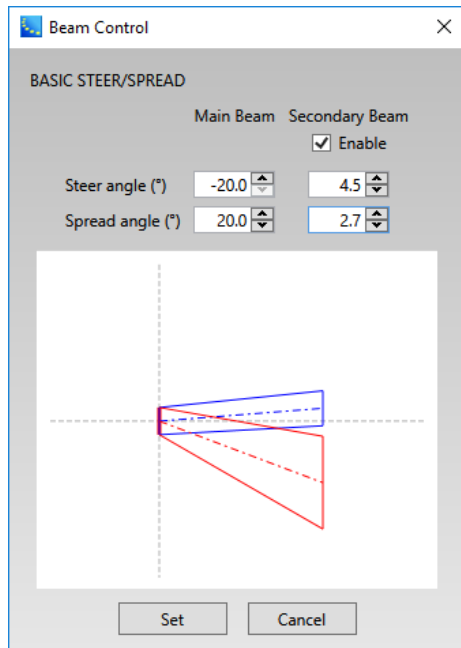

NOTE: The beam wire frames in CSD may look different from those in Modeler, even when the steering (and/or spreading) angle is the same. This is because, in Modeler, a user can specify the Distance (length) of the beam lines, which does not affect the beam of this beam type. As long as the steering (spreading) angle is identical, the radiated beam pattern is identical.

3. Click **Set** in the dialog to send the beam pattern to the array.

If you want the beam pattern to be available after power cycling the array, store it to a beam preset.

MSA12X Advanced Control Panel Options

This topic describes the advanced MSA12X control panel options. To access the advanced control panel, click the **Advanced** button in the main MSA12X control panel.

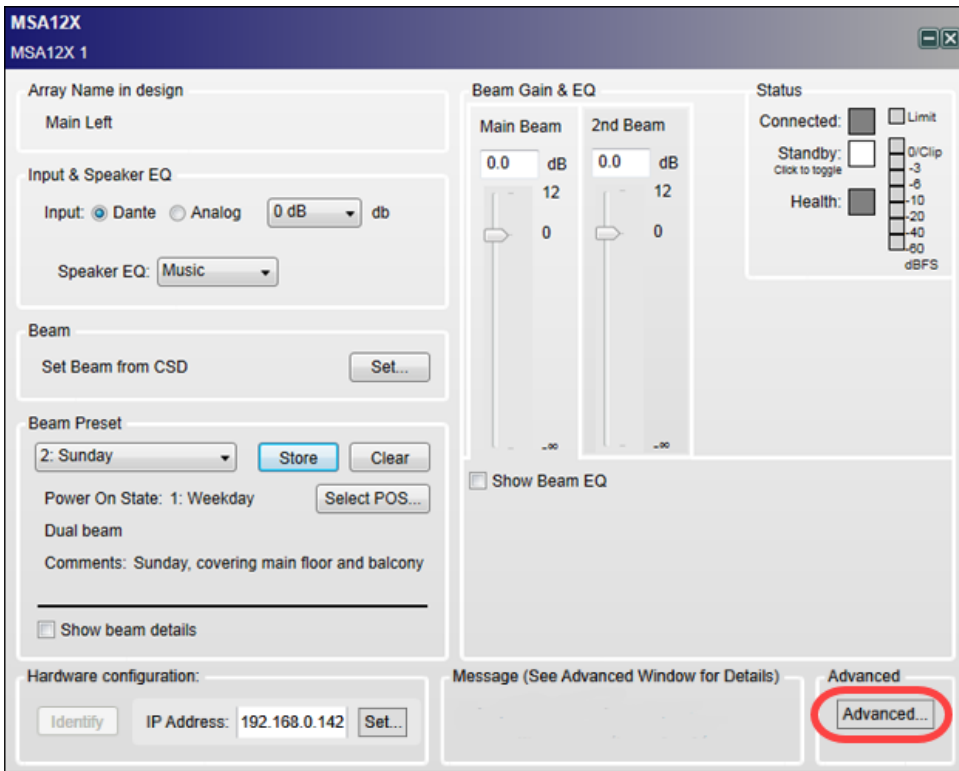

Accessing advanced MSA12X control panel from main control panel

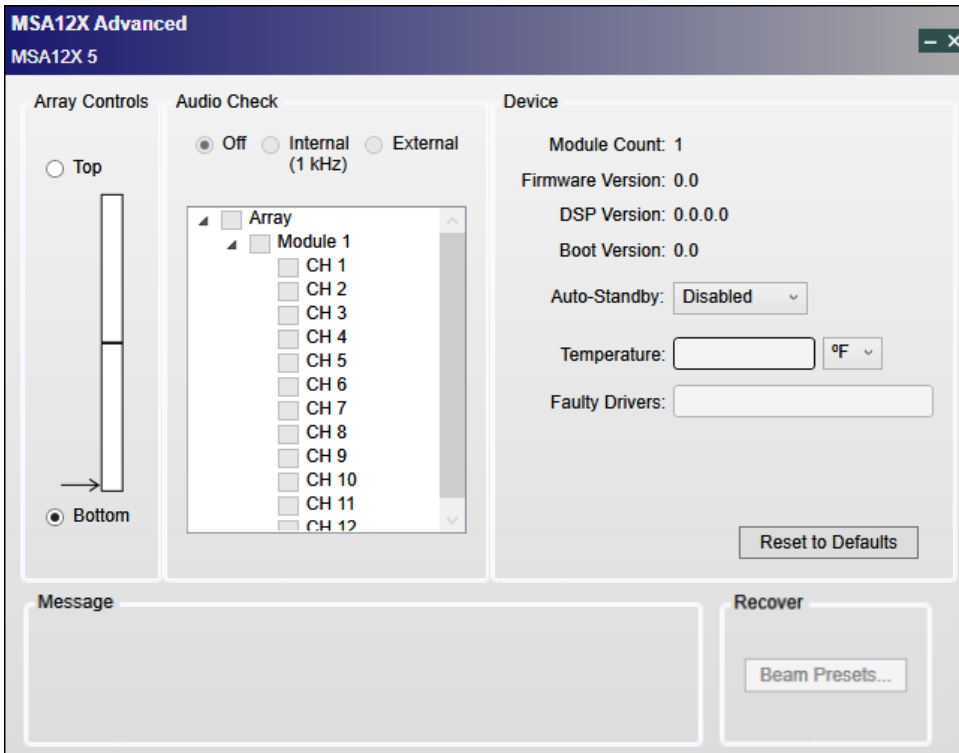

Advanced MSA12X control panel

The advanced MSA12X control panel provides the following options for the selected array:

Array Controls - The module where the external RJ45 network and power cables enter the MSA12X array is considered the master module (in single module arrays, there is only the master module).

MSA12X arrays can be physically mounted such that the power and RJ45 network cables entering the master module are located at the bottom end or top end of the array.

For correct beam orientation, you must set the Array Controls option to ensure that CSD software and beam steering settings reflect the physical location where the RJ45 and power cables enter the master module. For most installations, the bottom end of the array is used for these connections and is the default choice. For other installations, the array is physically turned 180 degrees so that the external cables and connectors enter at the top end. In this case, select Top, rather than Bottom.

Audio Check

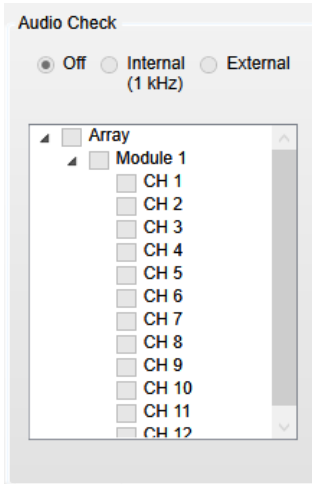

Advanced MSA12X control panel - audio check options

Off - turns test audio off (default).

Internal (1 kHz) - sends a 1 kHz test tone to the components of the array selected in the panel. You can select the entire array, one or more modules, or any of the drivers within a module for the test. Useful for testing the array or simply identifying the array in use.

External - same purpose and functionality as the Internal option, but allows use of an external audio program input for testing instead of a fixed tone.

Device

Module Count - number of modules in array.

Firmware Version - current version of firmware on array.

DSP Version - current version of DSP for array.

Boot Version - current version of boot loader for array.

Auto-Standby - automatically enables Standby (low or idle power) mode for the array after the selected amount of time that the audio input signal is absent. Can be used to reduce power consumption. Once an input signal is present for more than 6-10 seconds, normal mode resumes. Default: Standby mode disabled. **NOTE: Alternatively, you can enable Standby mode by turning on the Standby option in the main control panel.**

Temperature - indicates internal temperature of the array. Temperature units are selectable: °C or °F.

Faulty Drivers - lists the IDs of the drivers in the array that are faulty or inoperable (each module contains 12 drivers). Contact Bose support for further assistance.

Reset to Defaults - deletes all of the stored beam presets, including the power-on preset, and resets the array to its factory default settings. **NOTE: To remove an existing power-on preset, you must first select another preset and set it to be the power-on preset.**

Recover

Beam Presets - if you replace a module in an array for any reason, this copies the existing beam preset data from a selected "known good" module to the remaining modules so that all modules now share the beam preset data. **CAUTION: The beam preset data from the source module will overwrite any current beam preset data in all of the other modules.**

1. To recover a beam preset, click **Recover Beam Presets**.
2. In the Recover Beam Presets dialog, select the source module from which you will copy the beam preset data (Bottom - Module 1 in this example).

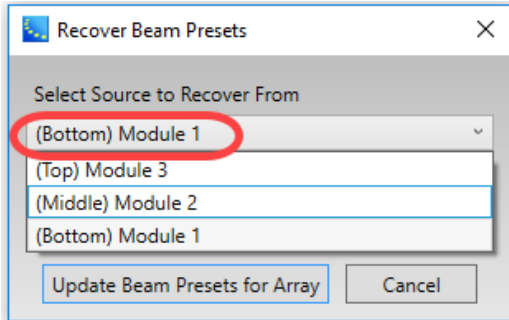

3. Click **Update Beam Presets for Array**.
4. In the next dialog, click **OK** to confirm the operation.

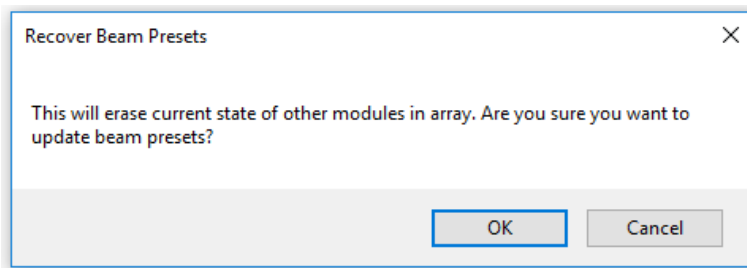

Assigning MSA12X Beam Presets to Parameter Sets

Once you store a beam preset for an MSA12X array, you can assign it to a parameter set and then recall it later manually, using an external trigger- such as GPI, GPO, or a control center - or via a timed event. As with any programming of parameter sets, you can only assign beam presets to a parameter set when in off-line mode.

NOTES:

- You may not assign individual settings within a beam preset, such as beam EQ or beam gain, to a parameter set. Only the entire beam preset, which is a group of settings in the MSA12X control panel, may be assigned to or recalled from a parameter set.
- In the ESP-880, 1240, 4120, and 1600 sound processors, a Dante network card is required before you can assign beam presets to parameter sets.

Before you can assign a beam preset to a parameter set, you must associate the Dante endpoint block corresponding to the MSA12X device with the appropriate sound processor, i.e. drag the Dante endpoint block or blocks for the MSA12X into the sound processor's Signal Processing View. The process is the same for any Dante endpoint or microphone block - a general description of which can be found in **"Adding Dante Endpoint and Microphone Blocks to SP View" on page 395**. The procedure below assumes you have already created this association.

To assign a beam preset to a parameter set:

1. In the main MSA12X control panel for the MSA12X device, select (recall) the beam preset from the Beam Preset drop-down list.

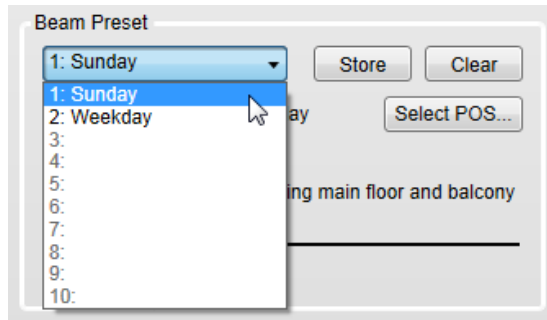

Selecting a beam preset

2. Open the Signal Processing View of the sound processor that the MSA12X device with the selected beam preset is associated with.
3. Drag the appropriate Dante endpoint block or blocks for the MSA12X from the design into the programming tree in the Parameter Set window.

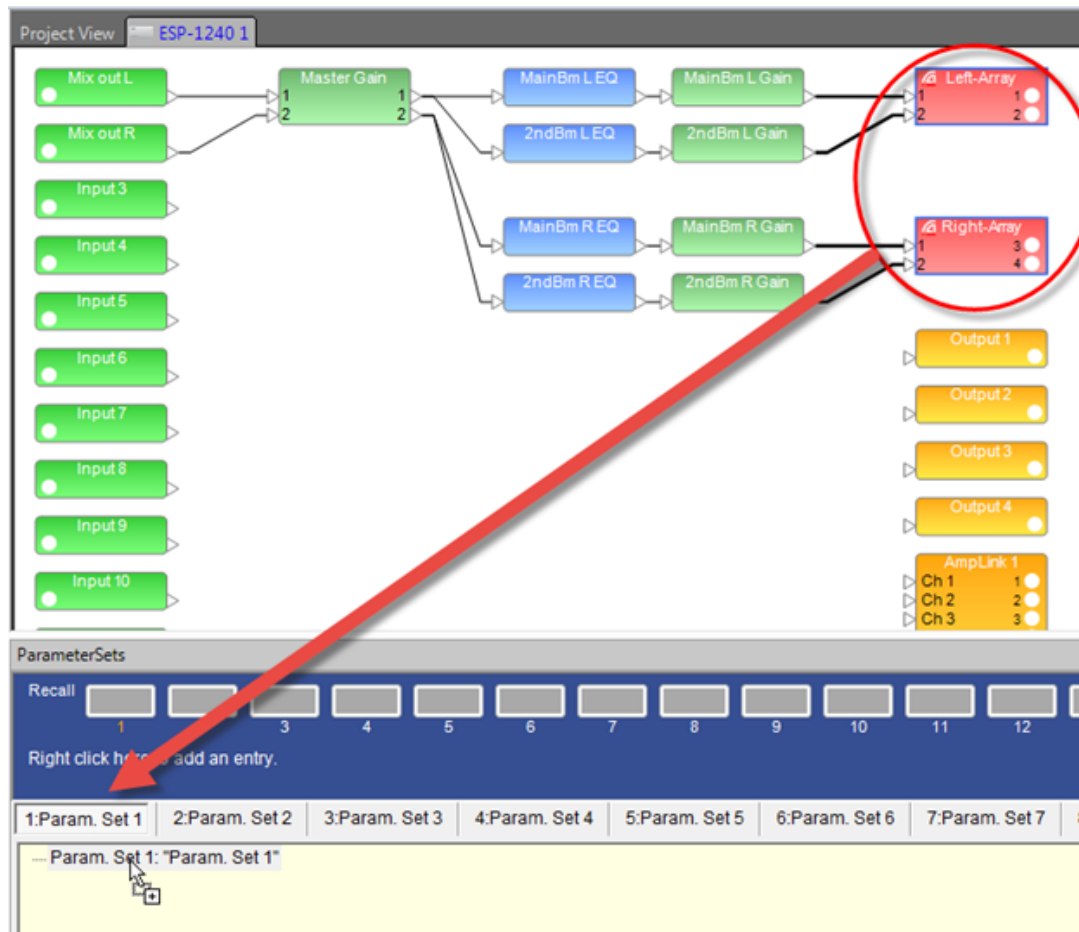

Dragging Dante endpoint blocks to the Parameter Set programming tree

4. In the Select Properties dialog, select **Endpoint properties** and click **OK**.

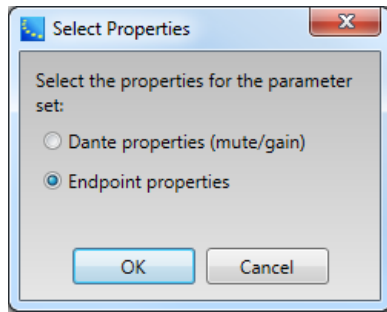

Select Properties dialog

The beam preset properties now appear in the Parameter Set window.

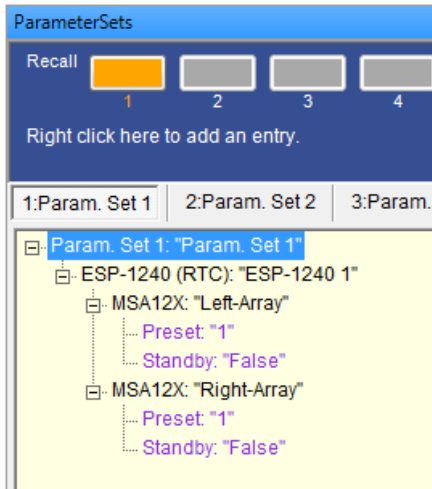

Beam preset properties in parameter set programming tree

Configuring Control Centers

CC-1, CC-2, CC-3 Zone Controllers

The Bose CC-1, CC-2, and **CC-3 Zone Controller** interfaces are engineered to provide custom on-site volume controls for engineered sound processors. They are all designed to connect via GPI ports.

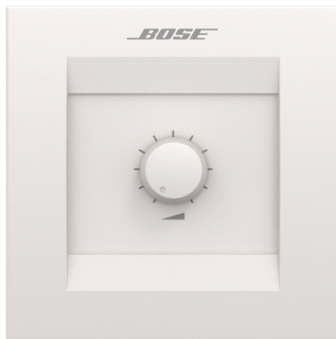

CC-1 Zone Controller



CC-2 Zone Controller



CC-3 Zone Controller

In ControlSpace Designer, these items are Project View icons only. The labels may be changed in the Project View, but there are no other properties or control panels to be configured. Functionality for the hardware devices is defined within the GPI control panel of the associated ESP or EX-1280C processor.

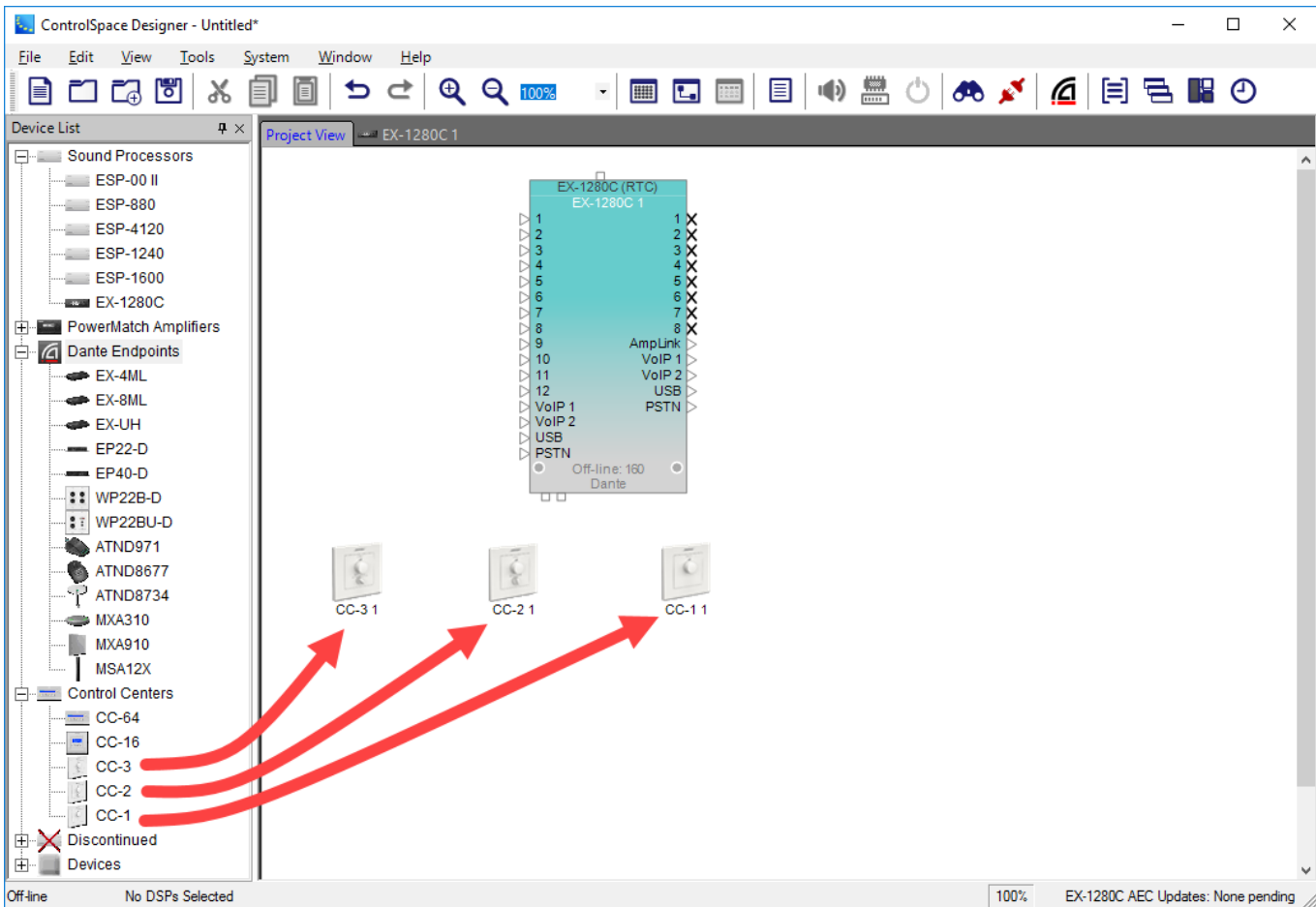

Bose zone controllers in Project View

Each of the hardware devices has individual characteristics and programming requirements as shown in the following table.

Control Type	Fully CW	Fully CCW	GPI Mode
CC-1	0 Ohms	10K Ohms	A-
CC-2	0 Ohms	10K Ohm	A- for Volume, D for switch selections
CC-3	10K Ohm	0 Ohms	A+ for Volume, D for switch selections

For details on connection to GPI ports, see [Programming GPIO](#).

For details on programming GPI ports, see [Programming GPI](#).

For programming information, see [Programming CC-1, CC-2, and CC-3 Zone Controllers](#).

CC-3 Zone Controller

The **CC-3 Zone Controller** is a wall-mounted control panel. It includes one rotary volume control and a four-position selector switch. Both the volume control and selector switch are designed to connect to GPI ports. See [Programming CC-1, CC-2, and CC-3 Zone Controllers](#) for details on associating signal processing features with a CC-3 via GPI ports.

A Project View icon is provided for project documentation purposes.

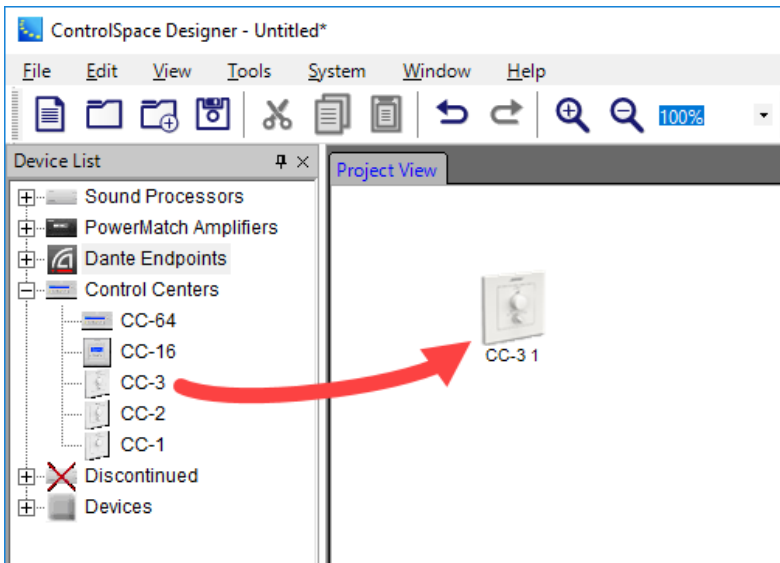

CC-3 Project View Icon



CC-3 Zone Controller

The CC-3 Zone Controller supports the following programming features:

Volume Control – Analog control input modes of individual GPI ports.

Selector Switch – Digital control input of individual GPI ports.

CC-16 Zone Controller

The CC-16 Zone Controller is a wall-mounted control panel. The CC-16 includes two selector buttons and two volume control buttons. It also has a two-line, 12 characters per line backlit LCD display. The selector and volume control buttons are fully programmable.

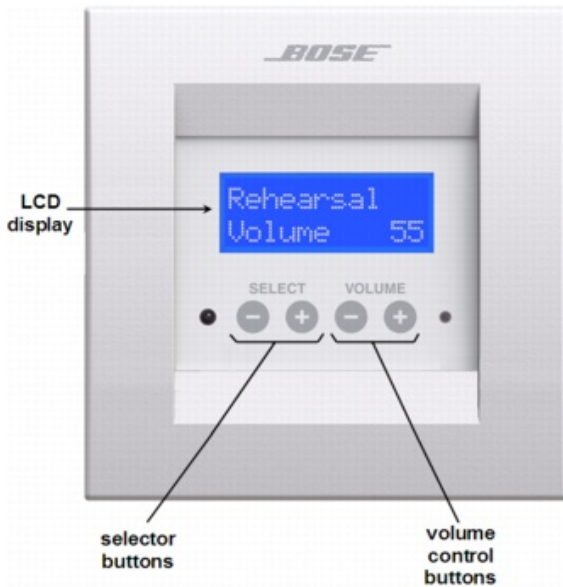

CC-16 Zone Controller

CC-16 Smart Simulator

The CC-16 Smart Simulator is a software-based tool within ControlSpace Designer used for programming and simulated operation of the CC-16 Zone Controller. When online, the buttons are functional and the LCD labels are synchronized with the hardware panel. To open the CC-16 Smart Simulator, double-click on the CC-16 block in Project View or right click and select **Open**.

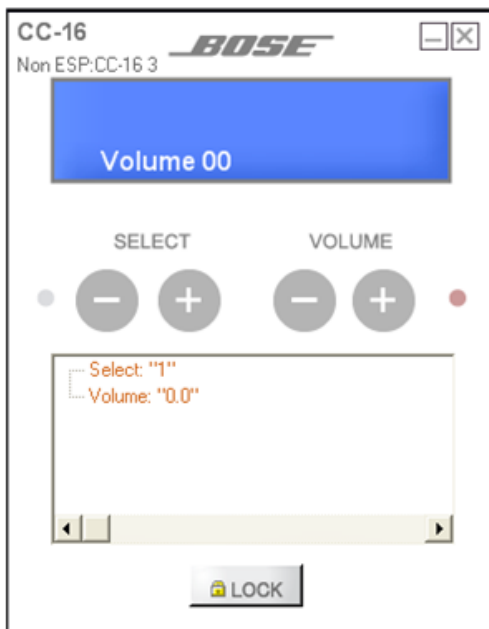

CC-16 Smart Simulator

The **CC-16 Smart Simulator** provides the following options:

Virtual LCD – Represents the two-line backlit display on the CC-16 zone controller.

Select – Provides minus and plus click zones to simulate selector button presses on the CC-16 zone controller.

Volume – Provides minus and plus click zones to simulate volume button presses on the CC-16 zone controller.

Programming Tree – Provides a landing zone for signal processing and other programmable elements. Assign functions to the Select buttons, or to the Volume control buttons by dragging and dropping onto the programming tree. See [Programming CC-16 Zone Controllers](#) for details on associating signal processing features with a CC-16.

Lock – displays the current lock state and provides a programming toggle button for adjusting the control panel lock. Locked panels are identified by the word "--Locked--" beside a green lock button. Locked status must be enabled or disabled from a parameter set.



CC-16 Locked and Unlocked Button States

NOTE: When an ESP or EX-1280C system is online and a control panel lock is enabled, software simulators respond to button clicks but matching hardware in the field no longer accepts input.

CC-16 Zone Controller Properties

To view or adjust CC-16 properties, right click on the device in Project View, and select **Properties**.

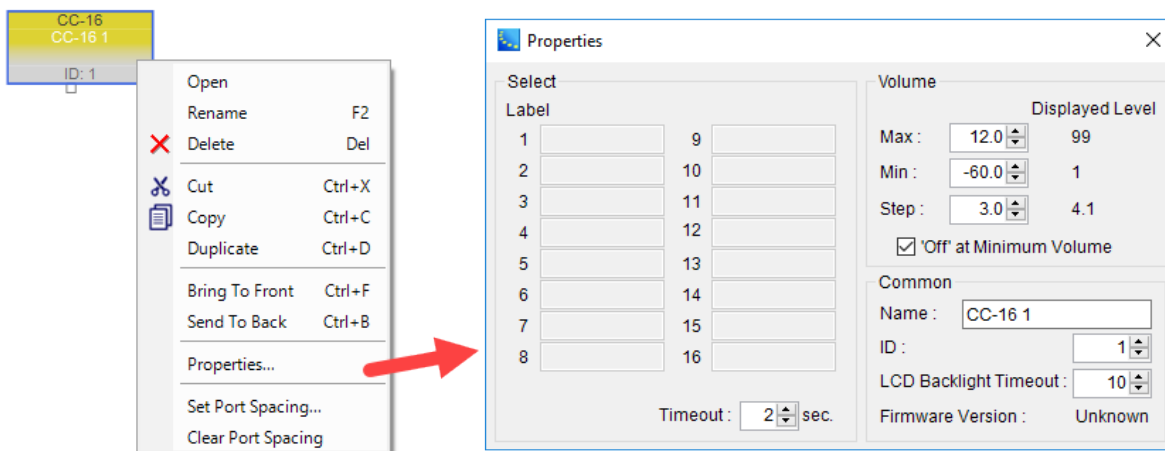

CC-16 Properties

Properties available for the CC-16 are as follows:

Select – provides configuration options for the minus and plus touchpad selector buttons.

Label – is a series of text fields which reflect the name of a selector position within the CC-16 display. Sixteen label fields are available. These labels are automatically populated when the Select buttons are associated with a Selector signal processing block or a list of parameter sets. After programming is complete, this label may be adjusted to a different value to match project needs.

Timeout – is an adjustable time value from 0 to 10 seconds for configuring the **Selection Preview** feature of the CC-16. The Selection Preview delay permits viewing other options programmed in the Select list before initiating a processing block change or recalling the parameter set. Returning to the initial selection before this time expires causes no system change.

A value of 0 seconds switches to the next selector position and initiates the programmed action immediately. Values from 1 to 10 seconds add this amount of delay for varying lengths of Selection Preview time.

Volume – provides configuration options for the minus and plus volume buttons.

Max: – configures the maximum volume level permitted by an associated signal processing block when pressing the plus button on the CC-16. The maximum value is +12dB.

This **Max** value always shows a display level of 99 on the CC-16.

Min: – configures the minimum volume level permitted by an associated signal processing block when pressing the minus button on the CC-16. The minimum value is -60dB.

This **Min** value always shows a display level of 1 on the CC-16.

Step: – configures the amount of change to an associated signal processing block when pressing either the minus or plus buttons on the CC-16. This value ranges from 0.5dB to 36.5dB.

Changing the Step value may round the Max and Mix limit values to the next step increment.

Displayed Level – always displays a value between 1 and 99 and is a calculated value based on current Max, Min, and Step settings.

'Off' at Minimum Value - when enabled, this feature allows the signal to be muted by pressing the minus button twice when the minimum value is reached. The display will show "OFF" once engaged. When disabled, the display will read "--".

Common – provides configuration options for the global characteristics of the control panel.

Name: – defines the name displayed on the CC-16 block within Project View. This field automatically updates to the current name if the CC-16 is renamed within Project View.

ID: – is a unique identification number assigned to each CC-16. Values range from 1 to 15. The default value is 1.

NOTE: Each time a new CC-16 is added to project view, this ID value must be adjusted to a unique number if more than one CC-16 exists within your system design. It must also match the DIP Switch settings of the associated CC-16 in the field for programming to operate correctly.

LCD Backlight Timeout: – establishes the amount of time in seconds that a CC-16 display remains illuminated after the most recent button press. Values range from 0 to 30 seconds with a default of 10 seconds. A value of 0 seconds forces the display to remain illuminated continuously.

Firmware Version: – displays the current version of firmware available within each system to manage CC-16 operations. Before the first connection to existing hardware, this value is listed as *Unknown*. After the first connection in a ControlSpace Designer program session, this field is automatically updated to reflect current firmware version.

CC-16 Zone Controller – Monitor Mode

When ControlSpace Designer is started in **Monitor Mode**, the CC-16 Smart Simulator appearance is altered to show only user adjustable click zones and *Lock* status. In this mode, the programming tree is no longer visible to prevent user tampering with programmed objects.



*CC-16 in Monitor Mode***CC-64 Control Center**

The CC-64 Control Center is a wall-mounted control panel. The CC-64 includes a master selector knob, four individual gain/selector knobs, four membrane bank select buttons, and a two-line 40 characters per line backlit LCD display. The master selector knob, gain/selector knobs, and display are fully programmable.

The upper right section of the panel has three LEDs indicating network link status, network data receive, and network data transmit. Each gain/selector knob is surrounded by 15 LEDs which indicate the relative position of the knob. Each bank selector button has an LED to indicate when it's active. The bottom line of the LCD display shows labels for the gain/selector knobs.

The four gain/selector knobs may control different signal processing functions in each of the four banks, for a total of sixteen settings. Use the bank selector buttons to assign control of the gain/selector knobs to one of the four banks at a time.

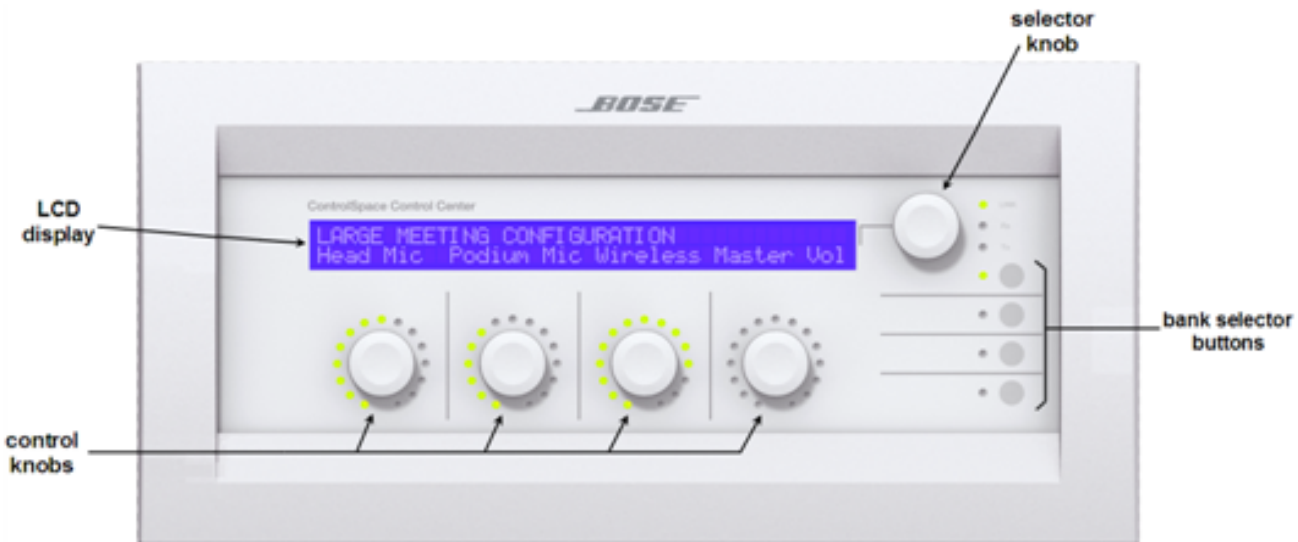
*CC-64 Control Center***CC-64 Smart Simulator**

The CC-64 Smart Simulator is a software-based tool within ControlSpace Designer used for programming and simulated operation of the CC-64 Control Center. To open the CC-64 Smart Simulator, double-click on the CC-64 block in Project View or right click and select **Open**.

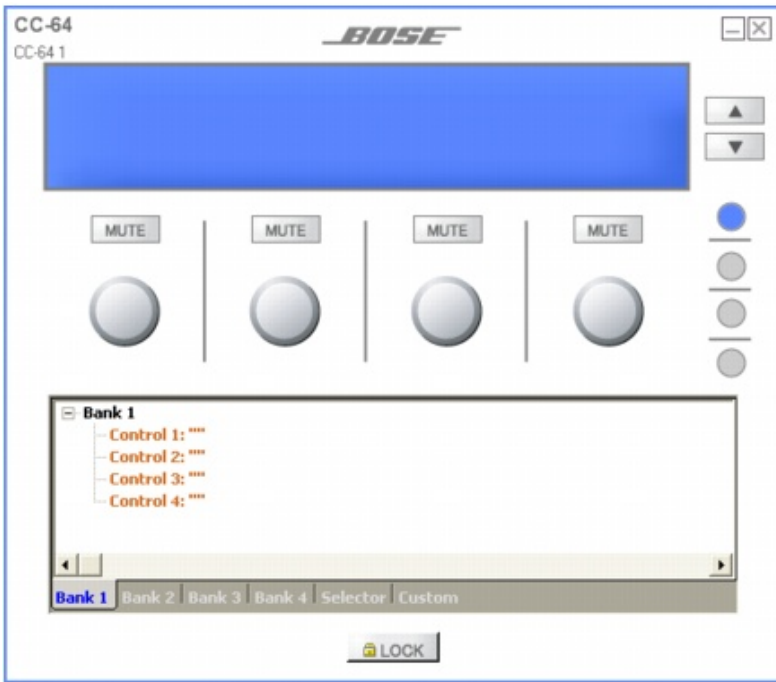

CC-64 Smart Simulator

The CC-64 Smart Simulator provides the following options:

Virtual LCD – Represents the two-line backlit display on the CC-64 control center.

Master Selector Up/Down – Provides click zones to simulate the master selector knob rotation on the CC-64 control center.

Mute buttons – Provide click zones to simulate the push to mute functionality of the gain/selector knobs on the CC-64 control center.

Virtual gain/selector knobs – When programmed as a volume control, a virtual knob may be rotated by clicking on it and dragging the mouse. When programmed as a selector, the virtual controls change to up/down arrows like the Master Selector.

Virtual bank selector buttons – Simulate bank selection of the CC-64 control center.

Programming Tree – Provides a landing zone for signal processing and other programmable elements. Assign functions to the master selector, gain/selector knobs, or to bank selector buttons by dragging and dropping onto the programming tree. See [Programming CC-64 Control Centers](#) for details on associating signal processing features with a CC-64.

Lock – Displays the current lock state and provides a programming toggle button for adjusting the control panel lock. Locked panels are identified by the word "--Locked--" beside a green lock button. Locked status must be enabled or disabled from a parameter set.



CC-64 Locked and Unlocked Button States

NOTE: When an ESP or EX-1280C system is online and a control panel lock is enabled, software simulators respond to button clicks but matching hardware in the field no longer accepts input.

CC-64 Control Center Properties

To view or adjust CC-64 properties, right click on the device in Project View, and choose **Properties**.

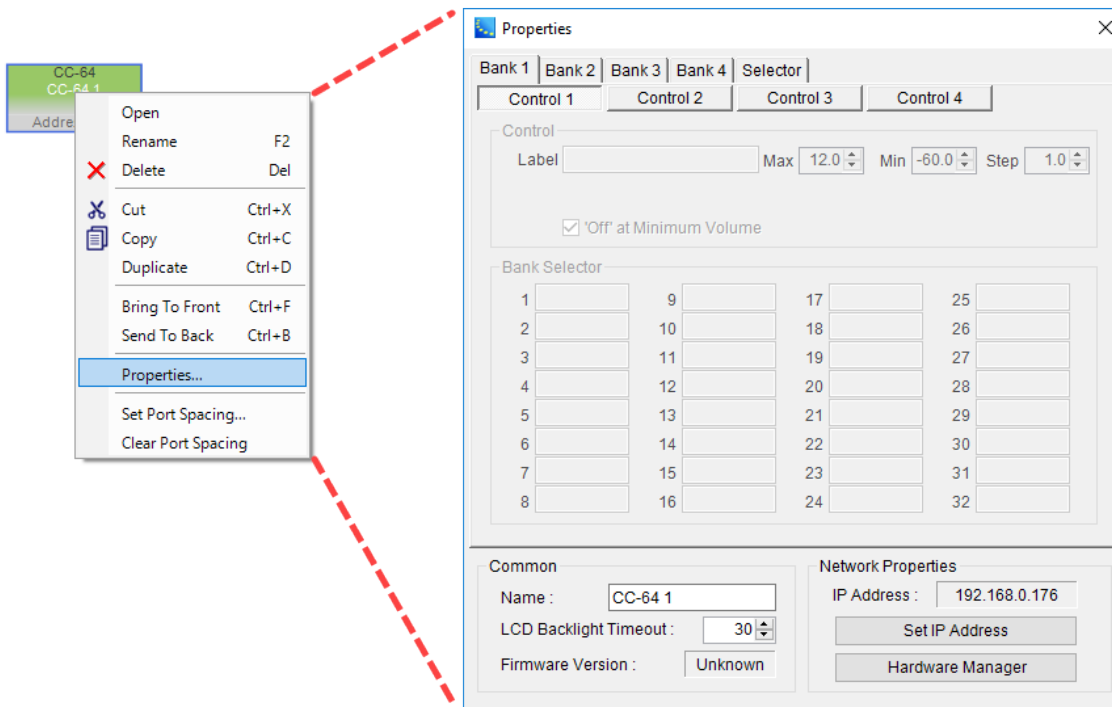

CC-64 Properties

Properties for the CC-64 include:

Bank/Selector Tabs – Display options for the bank and master selector configuration pages of the CC-64. Click a tab to view options for each configuration page.

Control Buttons – Correspond to individual settings available for each gain/selector knob.

Control – Sections display unique options for each gain/selector knob on the CC-64 from 1 to 4.

Max: – Configures the maximum volume level permitted by an associated signal processing block when rotating the gain/selector knobs clockwise on the CC-64. The maximum value is +12dB.

Min: – Configures the minimum volume level permitted by an associated signal processing block when rotating the gain/selector knobs counterclockwise on the CC-64. The minimum value is -60dB.

NOTE: When the gain/selector knobs are fully rotated in either direction, levels shown on the CC-64 LCD display match the value stored in the Max / Min fields.

Step: – Configures the amount of change to an associated signal processing block when rotating a gain/selector knob on the CC-64. This value ranges from 0.5dB to 36.5dB and defines the **Max** and **Min** levels permitted.

Label – Text field to customize the name of a gain/selector knob within the CC-64 display. This text appears on the second line of the LCD display directly above each knob and is automatically populated by the associated signal processing block selector position name or parameter set name when the panel is programmed. After programming is complete, this label may be adjusted to a different value to match project needs.

The first 9 characters of this label are displayed by default. Each time a bank is selected, labels for its four gain/selector knobs are displayed for one second. Any additional characters in the label are then scrolled horizontally in the display from right to left then left to right to permit viewing the complete label.

'Off' at Minimum Value - When enabled, the audio will be muted and the display will show "OFF" when the volume knob is rotated past the minimum value.

Common – Provides configuration options for the global characteristics of the control panel.

Name: – Defines the name displayed on the CC-64 block within Project View. This field automatically updates to the current name if the CC-64 is renamed within Project View.

LCD Backlight Timeout: – Establishes the amount of time in seconds that a CC-64 display remains illuminated after the most recent button press. Values range from 0 to 30 seconds with a default of 30 seconds. A value of 0 seconds forces the display to remain illuminated continuously.

Firmware Version: – Displays the current version of firmware available within each system to manage CC-64 operations. Before the first connection to existing hardware, this value is listed as *Unknown*. After the first connection in a ControlSpace Designer program session, this field is automatically updated to reflect current firmware version.

Network Properties

IP Address: – Unique network identification number assigned to each CC-64. Values may be any IP address within the same subnet of the system under control that is not already in use. The default value is 192.168.0.176.

NOTE: CC-64 control centers should be physically connected to the network one at a time and programmed with unique IP Addresses to avoid conflicts with other devices on the network configured with the default address.

Set IP Address – Allows you to change the IP address of the device.

Hardware Manager – Opens the Hardware Manager dialog (see [Launching the Hardware Manager](#)).

CC-64 Control Center – Monitor Mode

When ControlSpace Designer is started in **Monitor Mode**, the CC-64 Smart Simulator appearance is altered to show only user adjustable click zones and *Lock* status. In this mode, the programming tree is no longer visible to prevent user tampering with programmed objects.



CC-64 in Monitor Mode

Controlling System Devices

Programming Overview

ControlSpace Designer software allows you to create associations between signal processing and control center operations to meet the unique requirements of any project. These various associations are stored within ControlSpace System Project files (.CSP) on the programming computer and within ControlSpace hardware devices for recall on demand, both manually and automatically.

The process of defining relationships between processing and control options into a single integrated project file is called "programming the system." The primary work area within the ControlSpace Designer user interface where control options of system programming are stored is called the *Control Library*.

To get started, see:

[Programming Work Space](#)

[Parameter Sets](#)

[Programming Dante Subscriptions into Parameter Sets](#)

[Groups](#)

[RCGroups](#)

[Timers](#)

[Programming With Composite Device Blocks](#)

Control Library

Programming Work Space

The primary work area for programming is the "drop zone" for drag-and-drop control functions. The following control library function types are available for use in this work space:

- [Parameter Sets](#)
- [Parameter Set Lists](#)
- [Groups](#)
- [RCGroups](#)
- [Timers](#)

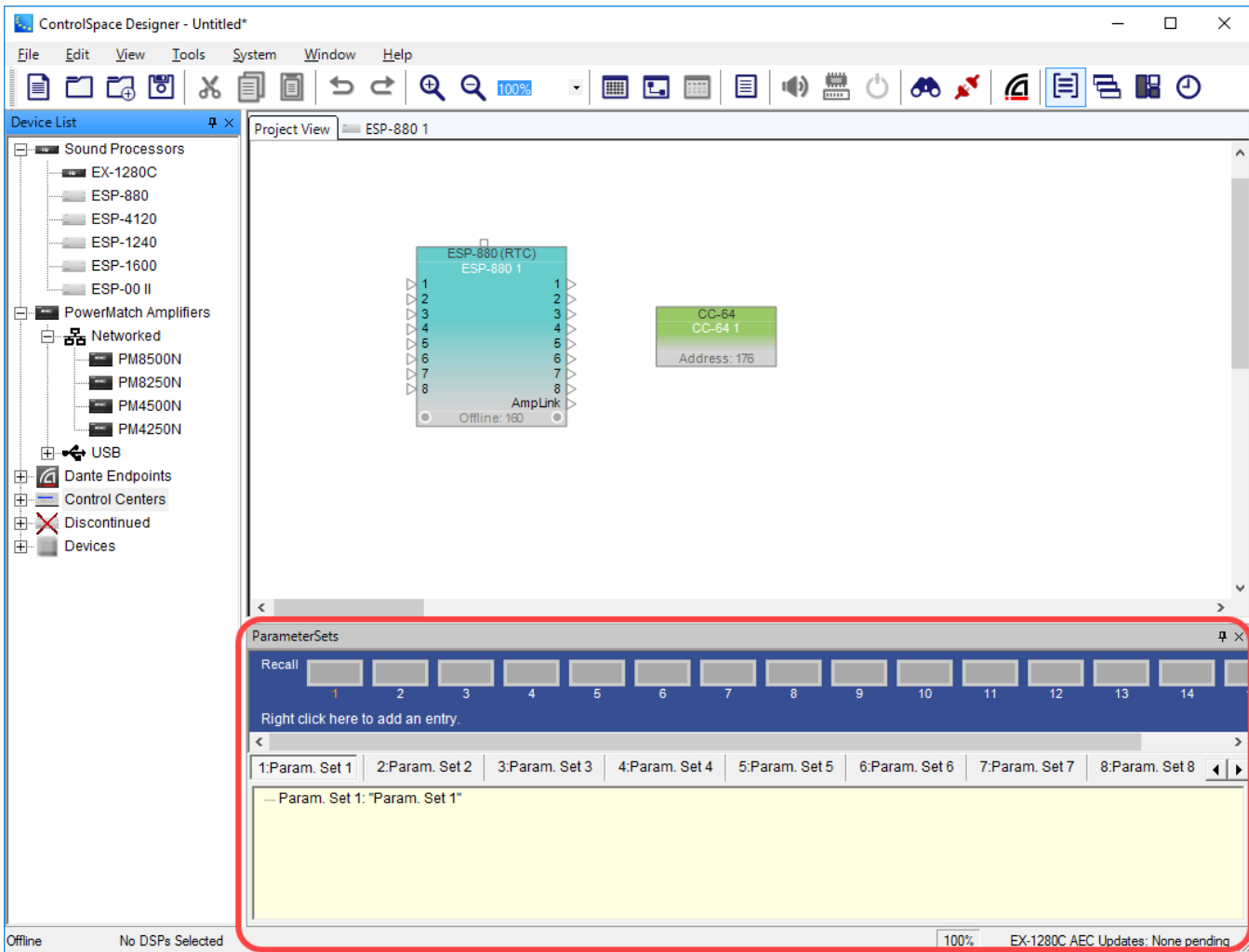

Programming Work Space

Parameter Sets

A parameter set stores selected signal processor settings and values which can later be recalled manually using an external trigger, such as a GPI or control center, or invoked by a timed event. Use parameter sets when you want to change the state of specific processing parameters without affecting the state of the entire design.

Access parameter sets by enabling the parameter sets window from the menu (**Window > Parameter Sets**).

Creating a Parameter Set

Open the Parameter Sets window by accessing the Window Menu and selecting **Parameter Sets**.

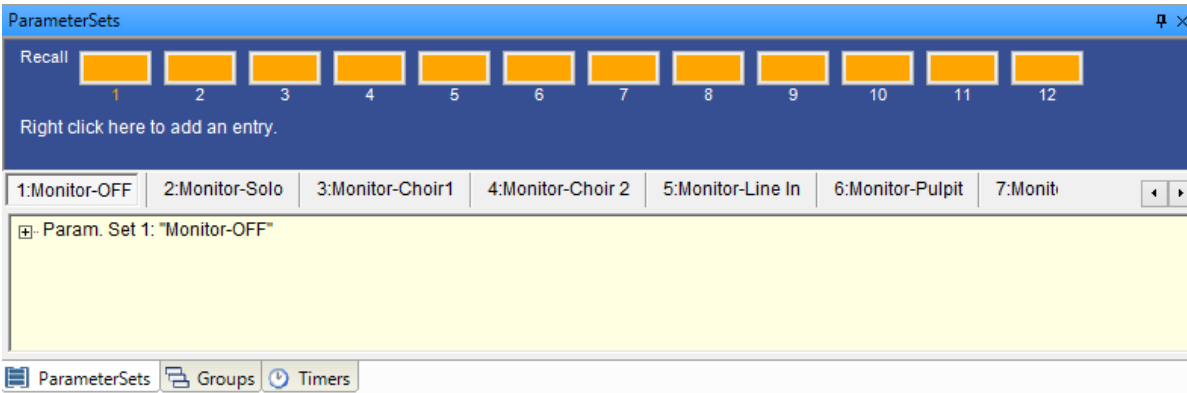

Parameter Sets window

To program a parameter set:

1. Open the control panel and change the settings for any signal processing block to be included in the parameter set.
2. Drag the desired processing blocks into the parameter set tree in the Parameter Set window.
3. Rename the parameter set using the right-click menu or F2 key.
4. Test the parameter set.

Tip: Right-click on an object in the tree structure and select **Open** to open the control panel for that object.

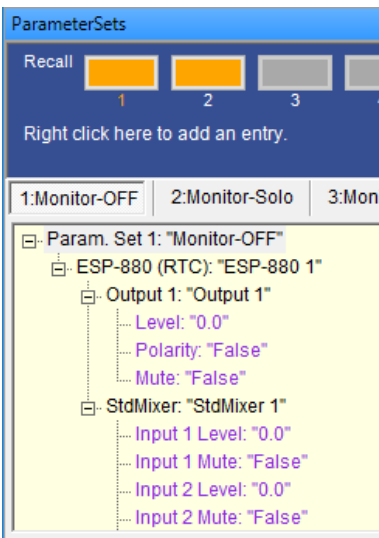

Parameter set tree structure

Another way to add blocks to a parameter set is to select one or more blocks, right click, and choose **Add To Parameter Set**.

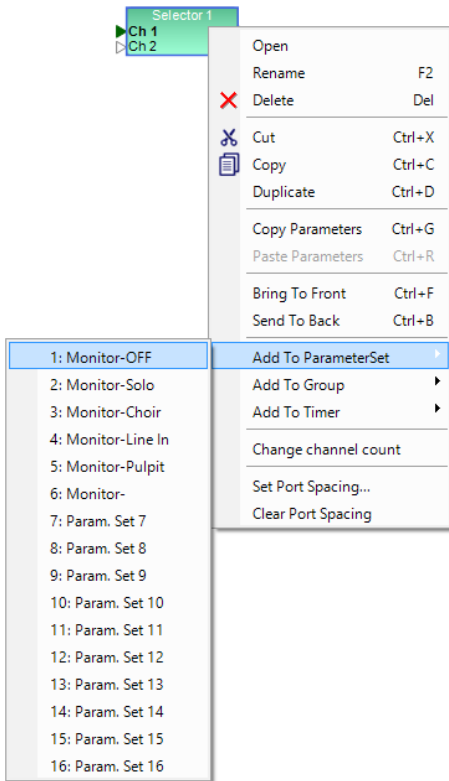

Right click to add to a parameter set

NOTE: To change the value of a setting in the parameter set, first change the setting in the block’s control panel and then drag and drop it into the parameter set once more. You do not need to delete the block from the parameter set to update its settings.

Renaming a Parameter Set

To rename the parameter set, select the top level of the tree structure and press F2, or right click and choose **Rename**.

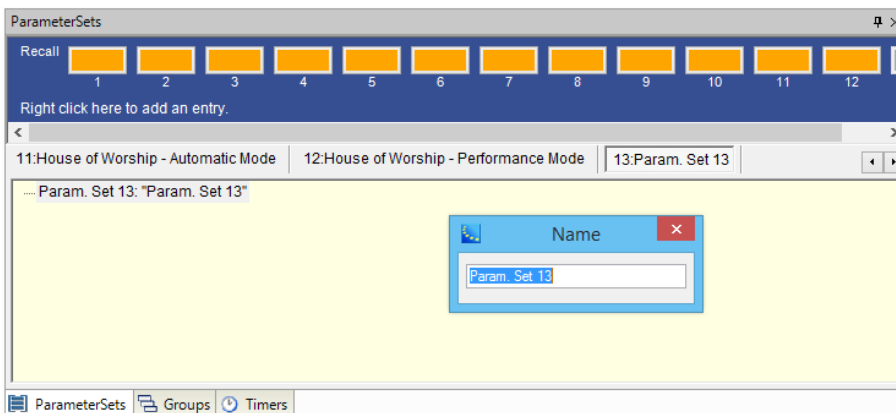

Rename the parameter set

Editing Parameter Sets

The values of parameters are displayed but cannot be changed within the Parameter Sets window. If you need to change the value of a specific setting that is part of a parameter set (for example, a gain of -6 dB), you will need to change the setting of the signal processing block’s control panel, and then drag and drop the block once more into the parameter set.

Copy/Paste Parameter Sets

Parameter sets can be copied and pasted. Right-click on a parameter set within the Parameter Sets window to access the copy/paste functions.

Select a parameter set within the Control Library or Project Directory by right-clicking on it, then select **Copy** from the context menu. You can now paste the signal processing blocks in this Parameter Set to a second Parameter Set using one of two options:

Paste – Places an exact copy of the parameter set and its settings.

Paste as Default Parameters – Copies the modules associated with the parameter set, but restores them to their default values. For example, if a parameter set has a gain module with the level set to -6 dB and Mute is true, **Paste as Default Parameters** will paste the gain module but reset the level and mute to their default values, i.e., 0 dB and unmuted.

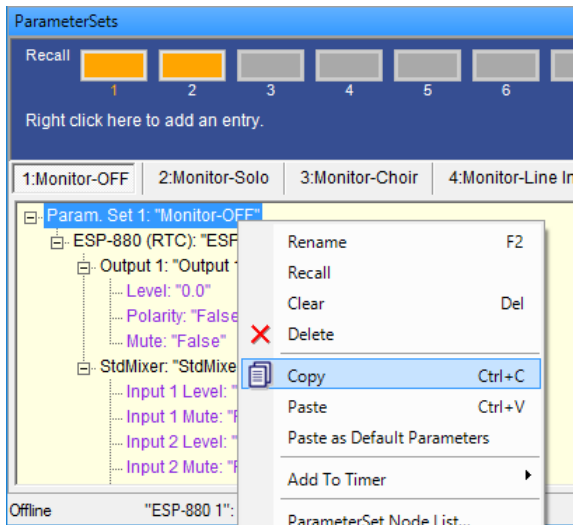

Parameter set copy

NOTE: When pasting a parameter set, any existing parameter set data is overwritten.

Adding More Parameter Sets

The default number of parameter sets in the Parameter Sets window is 16, but additional parameter sets may be added.

To add more parameter sets, right-click anywhere in the blue area where the **Right click here to add an entry** text is displayed. Then, click the **Add Parameter Set** pop-up option to add a new parameter set at the end of the list.

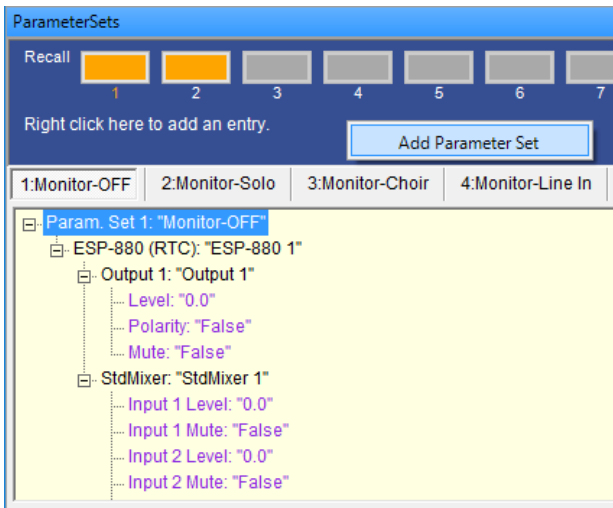

Adding a parameter set

Recalling Parameter Sets

Parameter sets may be invoked (recalled) while off line in order to test parameter set programming. This recalls the state of all signal processing blocks within the parameter set to the stored values. The last recalled parameter set is indicated by an orange-colored button above the parameter set's number in the Recall area.

To test a parameter set, open any signal processing blocks included in the parameter set to display their control panels and then recall the parameter set by clicking its orange button in the Recall area. Alternatively, you can right-click on the parameter set name in the tree and select **Recall** from the menu.

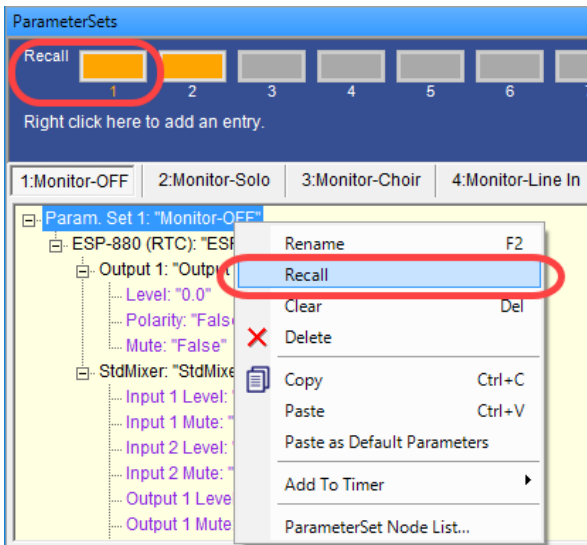

Recalling a parameter set

You can then view any setting changes in the signal processing blocks' control panel(s).

Clearing Parameter Sets

To clear the programming of a parameter set, right-click on the top level of the parameter set's tree structure, and select **Clear**. This removes the programming but leaves the empty parameter set to be used again.

CAUTION: Selecting Delete removes the entire parameter set and its programming. Deleting a parameter set entirely could affect serial control programming with third-party devices.

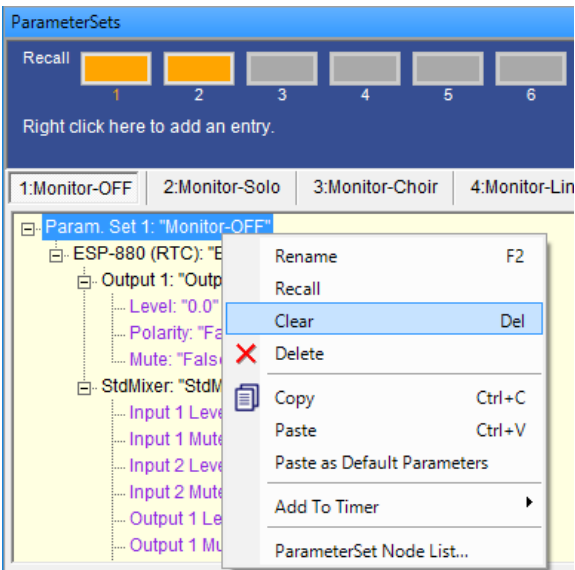

Clear a parameter set

Parameter Set Nodes List

Parameter sets may also be created or modified using the Parameter Set Nodes List. To access the Parameter Sets Nodes list, double-click on the parameter set name in the Parameter Sets window. The Parameter Set Nodes List may also be accessed using the right-click option. Once enabled, the Parameter Set Nodes List window shows all signal processing nodes in your system, and indicates those assigned to the parameter set.

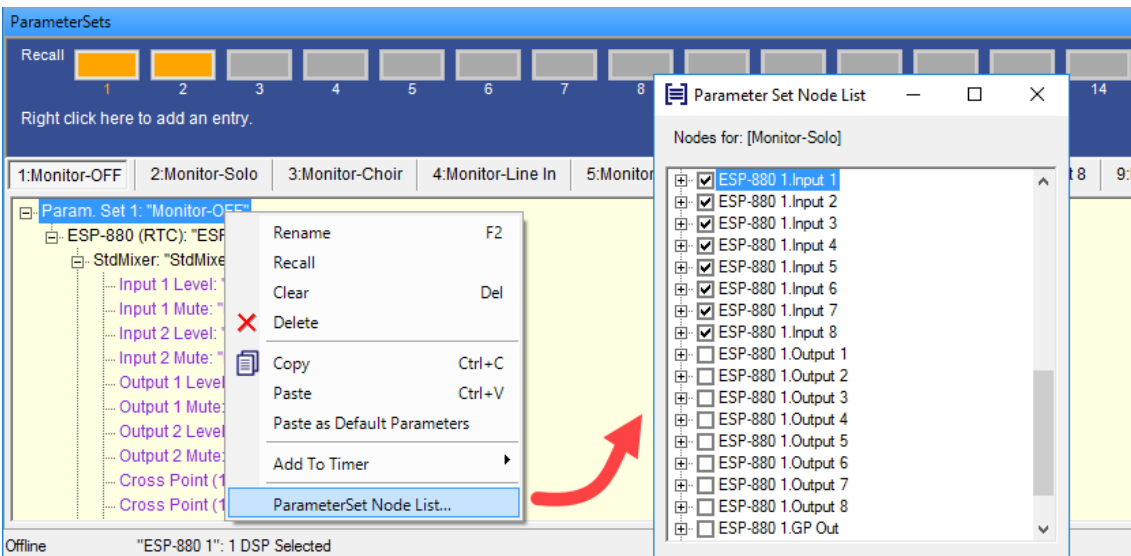

Opening the Parameter Set Nodes List

From within the Parameter Sets Nodes List it is possible to determine exactly which processing functions from all system devices are included in the parameter set. The list also displays the controls that are included for the signal processing functions.

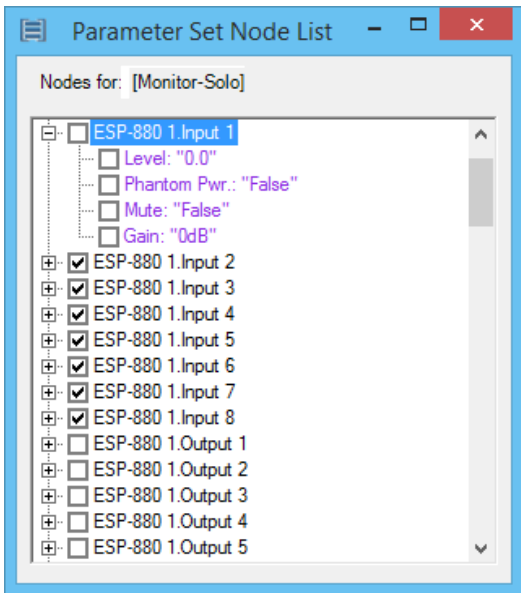

Expand a device to see properties

When creating new parameter sets, you may specify the settings you want to store. To store all settings for a given block, place a check mark next to the block name, as shown in the following figure. Note that all the settings within the block are automatically selected.

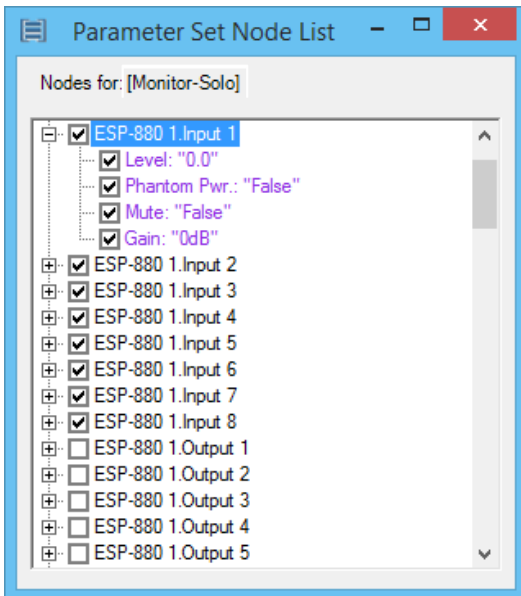

Include all settings for the device

Storing Individual Parameters

To include only specific settings in the parameter set, use the Parameter Set Nodes List and place a check mark next to the settings within the block, as shown in the following figure. When the parameter set is invoked, only the selected settings are changed, reducing the possibility of accidentally changing key system settings. Unselected settings are not part of the parameter set and remain unchanged when the parameter set is invoked.

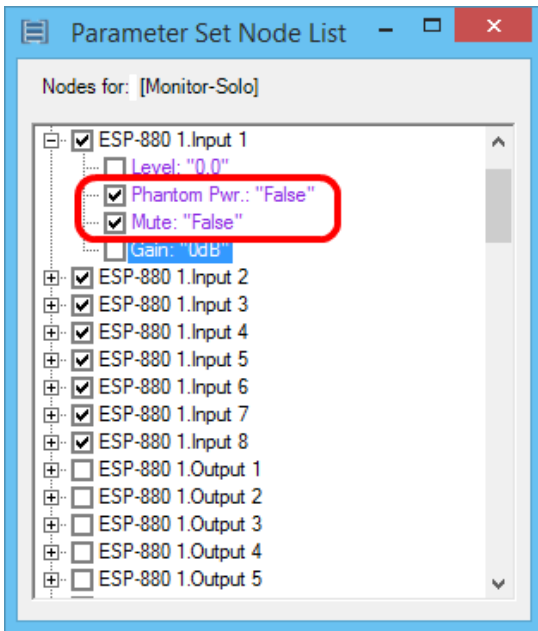

Include selected settings in the parameter set

You can also use the Parameter Set Nodes List to modify an existing parameter set. Open the Parameter Set Nodes List and check or uncheck the settings that you want to include in the parameter set.

Parameter Set Lists

A parameter set list is a collection of multiple parameter sets (described in ["Parameter Sets" on page 427](#)) consolidated under a single node. You can place a parameter set list on a control center (CC) block and arrange its parameter sets in the desired order.

Each parameter set list keeps track its most recently recalled parameter set, enabling CCs to display the system's status even when different groups of parameter sets control different aspects of the system.

Note: A parameter set can belong to only one parameter set list at a time.

To show or hide the Parameter Set List window, do one of the following:

Click the second icon in the last group of icons in the toolbar.

Click **Window** and select **ParameterSetLists**.

Right-click the top of any visible window in the project (**Device List**, **Project Directory**, etc.) and select **ParameterSetLists**.

Adding a Parameter Set List

There are 16 empty parameter set lists that you can use, but you can add more as well.

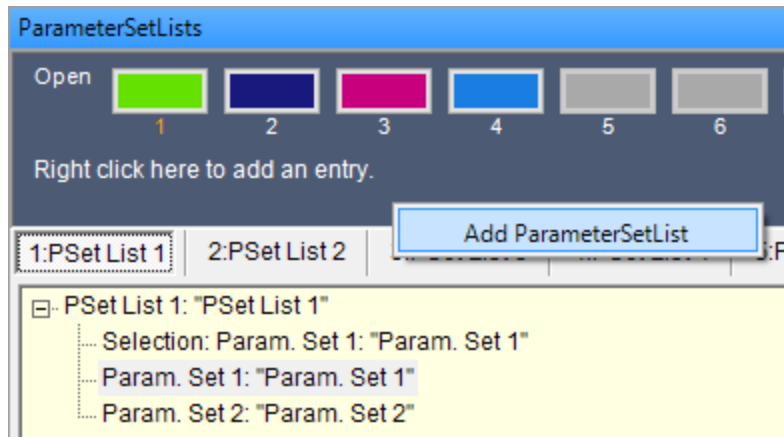

To add a parameter set list, right-click the blue-gray section at the top of the **ParameterSetLists** window and select **Add ParameterSetList**. A new list will be added to the end of the series.

Renaming a Parameter Set List

By default, all parameter set lists are named PSet List and appended with its number, but you can rename them to suit your project's needs.

To rename a parameter set list, do one of the following:

- Click the node of the desired parameter set list (so it is selected), and then press **F2**.

- Right-click the node of the desired parameter set list and select **Rename**.

Editing a Parameter Set List

By default, all parameter set lists are named **PSet List** and appended with its number, but you can rename them to suit your project's needs.

You can easily add or delete parameter sets to or from a list.

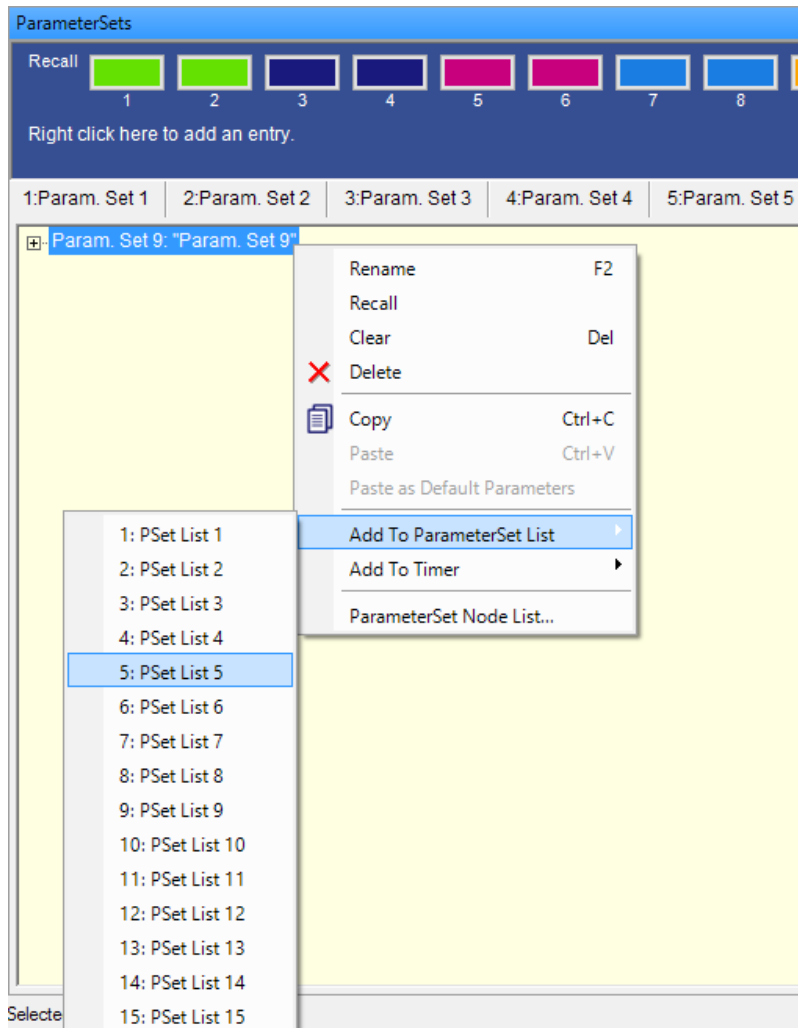

To add a parameter set to a parameter set list, do one of the following:

Click and drag the node of the desired parameter set (in the **ParameterSets** window) onto the node of the desired parameter set list (in the **ParameterSetLists** window), and then release it.

Right-click the node of the desired parameter set (in the **ParameterSets** window), select **Add to ParameterSet List**, and then click the desired parameter set list.

If a parameter set belongs to a parameter set list, its button in the **ParameterSets** window will match the color of its corresponding parameter set list.

Note: A parameter set can belong to only one parameter set list at a time.

To delete a parameter set from a parameter set list, do one of the following:

Under the expanded node of the parameter set list, click the desired parameter set to select it, and then press **Delete**.

Under the expanded node of the parameter set list, right-click the desired parameter set, and then click **Delete**.

Recalling Parameter Sets in a List

You can recall parameter sets while offline in order to test their programming. Doing so changes the settings of all signal processing blocks to the settings stored in the parameter set. The last-recalled parameter set is indicated by its orange number below its button in the **Recall** area (of the **ParameterSets** window).

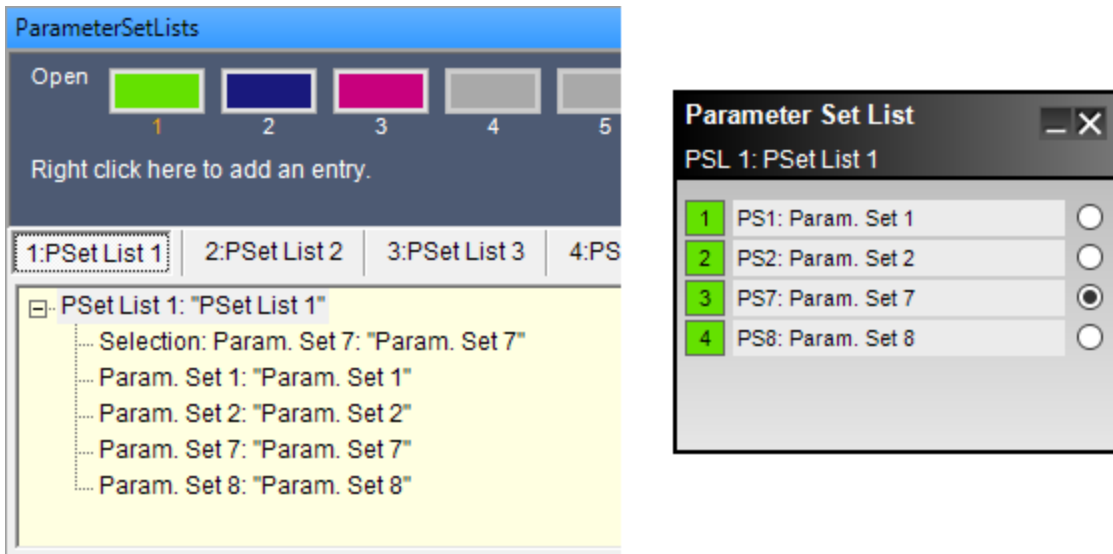

To test a parameter set in a list:

1. **Optional:** Open any signal processing blocks included in the parameter set to display their control panels.
2. Click its button in the **Open** area at the top of the **ParameterSetLists** window. Alternatively, right-click the node of the desired parameter set list and select **Open**.
3. In the **Parameter Set List** window that appears, click the desired parameter set to recall it.

You can then view any setting changes in the signal processing blocks' control panel(s), if you opened them in Step 1. Recalling a parameter set immediately changes the state of all signal processing blocks within it to the stored values.

Clearing & Deleting Parameter Set Lists

To clear the programming of a parameter set list, do one of the following:

- Click the top-most node of the desired parameter set list to select it, and then press **Delete**.
- Right-click the node of the desired parameter set list and select **Clear**.

This removes the parameter sets but leaves the empty parameter set list to be used again.

To delete the parameter set list entirely, right-click the node of the desired parameter set list and select **Delete**.

CAUTION: Deleting a parameter set list could affect serial control programming with third-party devices.

Managing Parameter Set Lists on a Control Center

You can load entire parameter set lists onto a control center (CC). This works similarly to individual parameter sets.

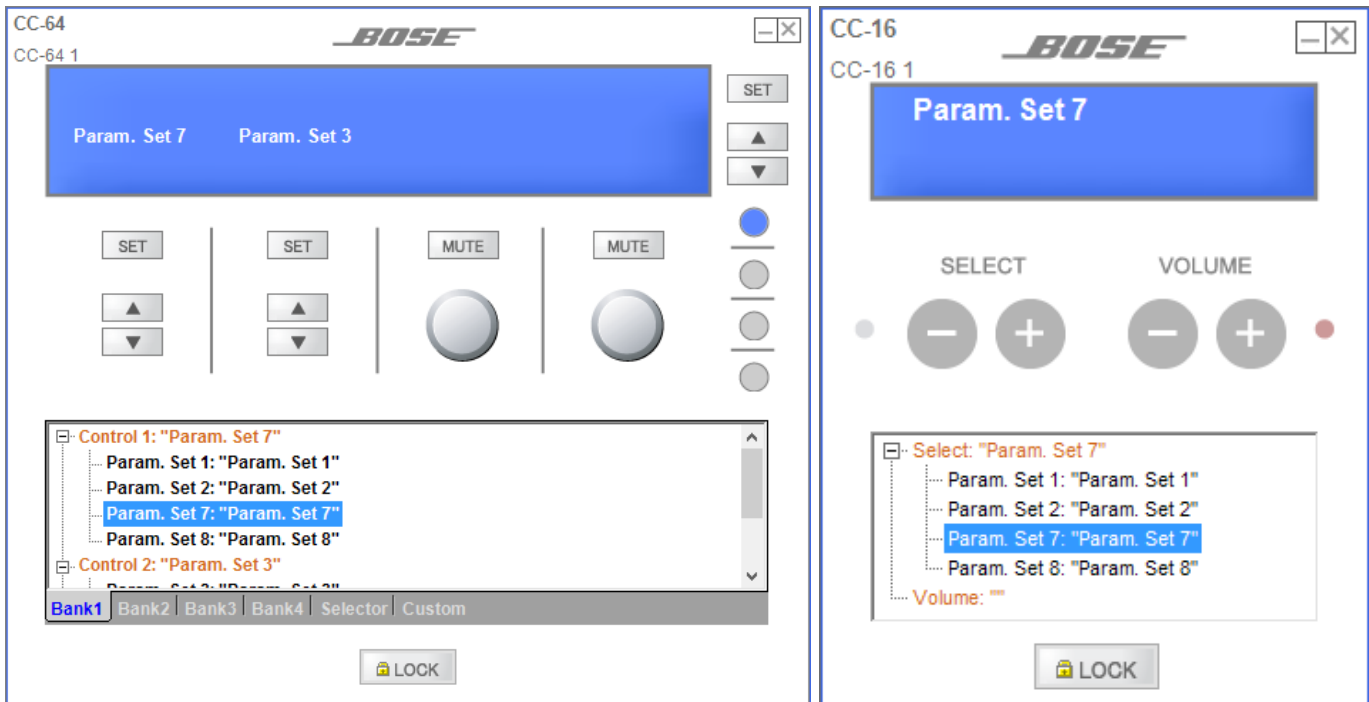

To load a parameter set list onto a CC, click and drag the node of the desired parameter set list (in the **ParameterSetLists** window) onto a node on the CC, and then release it. All parameter sets in the list will be added to the CC in sequence.

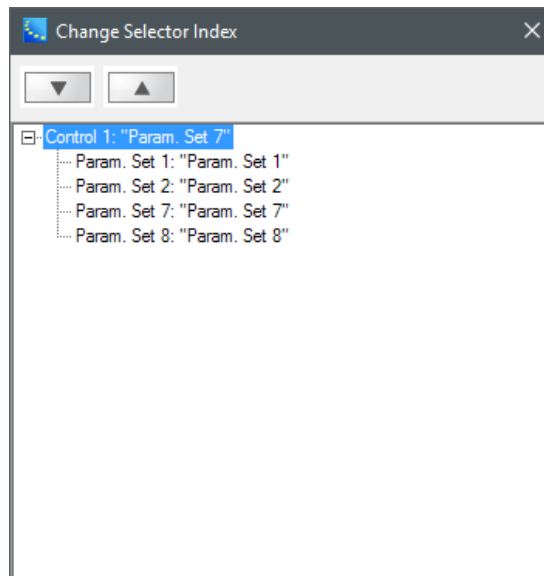

To reorder the parameter sets on a CC, do one of the following:

Under the expanded node on the CC, click and drag a parameter set up or down, and then release it at the desired location.

Double-click the node on the CC's window. In the **Change Selector Index** window that appears, click a parameter set to select it, and then click the **up** or **down arrow** buttons to change its location in the sequence. Alternatively, under the expanded node, click and drag a parameter set up or down, and then release it at the desired location. Close the window when you are done.

To delete a parameter set list from a CC, delete all of its parameter sets from that CC. Do this by doing one of the following:

Under the expanded node on the CC, click a parameter set to select it, and then press **Delete**. Alternatively, right-click the parameter set, and then click **Delete**.

Double-click the node on the CC's window. In the **Change Selector Index** window that appears, under the expanded node, click a parameter set to select it, and then press **Delete**. Alternatively, right-click the parameter set, and then click **Delete**. Close the window when you are done.

Programming Dante Subscriptions into Parameter Sets

Both ControlSpace® sound processors and PowerMatch® amplifiers when used with Dante™ network cards, endpoints, and other Dante-equipped devices have the capability to allow Dante input subscriptions to be programmed for later recall. This functionality is especially useful for systems that have many Dante audio channels available. Re-callable subscriptions allow only the desired Dante channels to be received, reducing the need for manual reprogramming or idle input channels, thus saving overall system costs.

Re-callable Dante subscriptions are set using parameter sets. Once programmed, parameter sets can be triggered by external events such as user controls or timers.

NOTES:

- **Adding Dante subscriptions into parameter sets requires Dante control to be enabled with applicable Dante devices active on the network.**
- **To include subscription information when adding Dante input blocks into parameter sets, you must first enable dynamic routing (see ["Enabling Dynamic Routing" on page 52](#)).**

To program a Dante subscription into a parameter set:

1. Open the Routing tab in the Dante properties control panel.

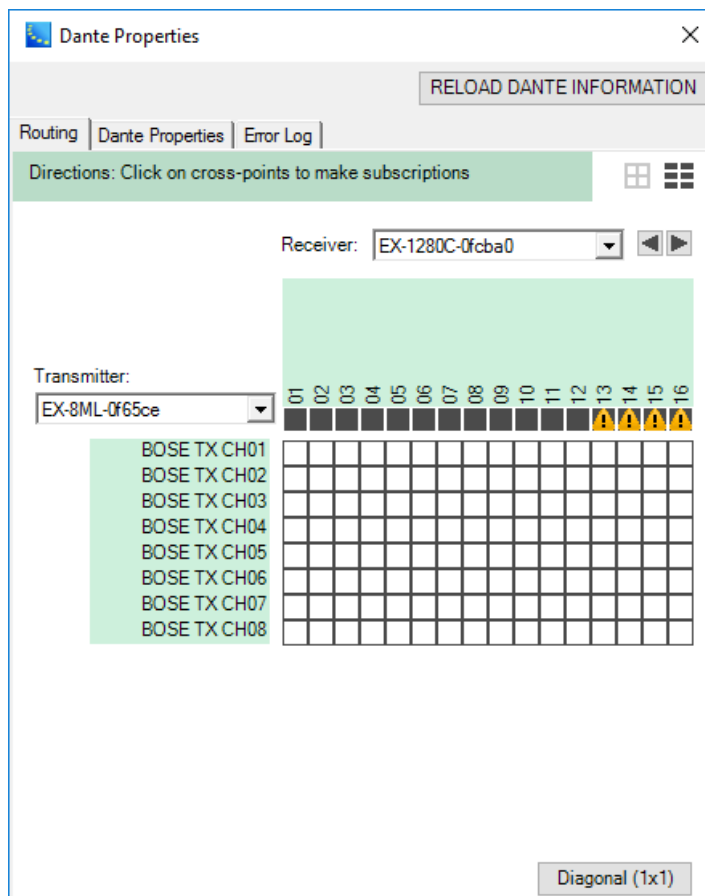

Dante Properties Window - Routing

- Set the desired channel routing using either the Matrix View or the Drag and Drop View (see [Dante Network Routing](#)).

RELOAD DANTE INFORMATION

Routing | Dante Properties | Error Log

Directions: Drag and drop channels from a transmitting card to the receiving card to make subscriptions.

Transmitting Dante devices

Transmitting channel	Signal	Transmit Flow
▶ EX-1280C-0fcba0		
▼ EX-8ML-0f65ce		edit multicast flows +
BOSE TX CH01	▶	unicast
BOSE TX CH02	▶	unicast
BOSE TX CH03	▶	unicast
BOSE TX CH04	▶	unicast
BOSE TX CH05	▶	unicast
BOSE TX CH06	▶	unicast
BOSE TX CH07	▶	unicast
BOSE TX CH08	▶	unicast

Receiving Dante device: EX-1280C-0fcba0

Receiving channel	Signal	Connected to	Status	Receive Flow
01	▶	BOSE TX CH01@EX	✓	unicast
02	▶	BOSE TX CH02@EX	✓	unicast
03	▶			
04	▶			
05	▶			
06	▶			
07	▶			
08	▶			
09	▶			
10	▶			
11	▶			
12	▶			

Dante Routing - Drag and Drop View

TIP: Input subscription recall only applies to a Bose ESP, EX-1280C, or PowerMatch amplifier.

- Open the Signal Processing View of the sound processor or amplifier that has Dante input routing you would like to store.
- Open the parameter set window. Drag and drop the target input block into the desired parameter set. The section on ["Parameter Sets" on page 427](#) contains additional information and methods for programming parameter sets.

For sound processors, select the Dante input block to drag and drop.

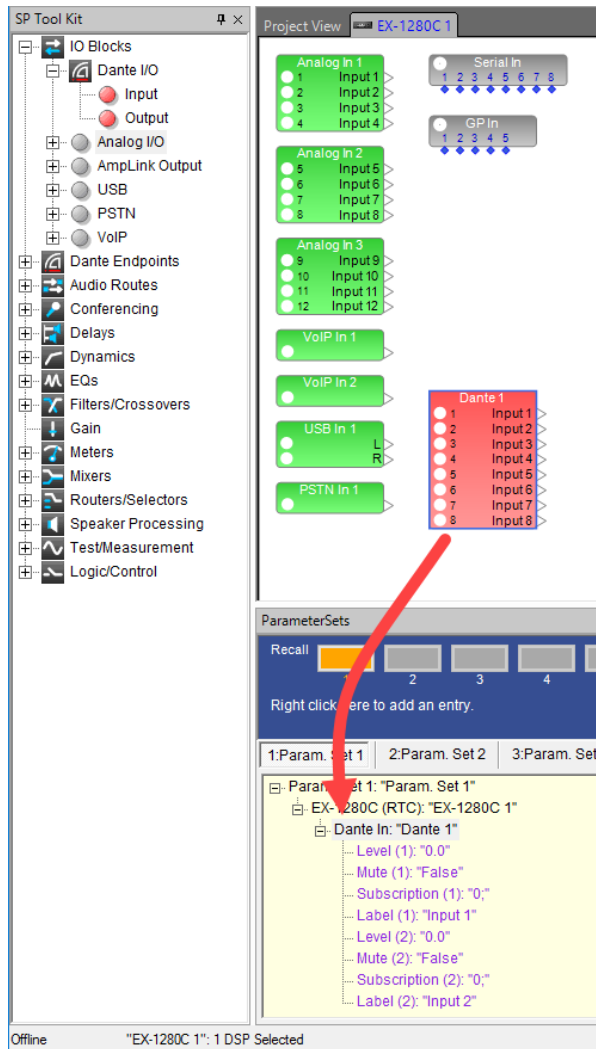

Dragging Dante Input block into parameter set 1

Once dropped, you will then be presented with a selection option dialog box. Select the channel or channels to which you would like to assign Dante subscription behavior.

For PowerMatch amplifiers, select the individual input block to drag and drop.

TIP: For PowerMatch amplifiers, ensure the desired input channel for Dante audio is set to Digital (see [Input Control](#)).

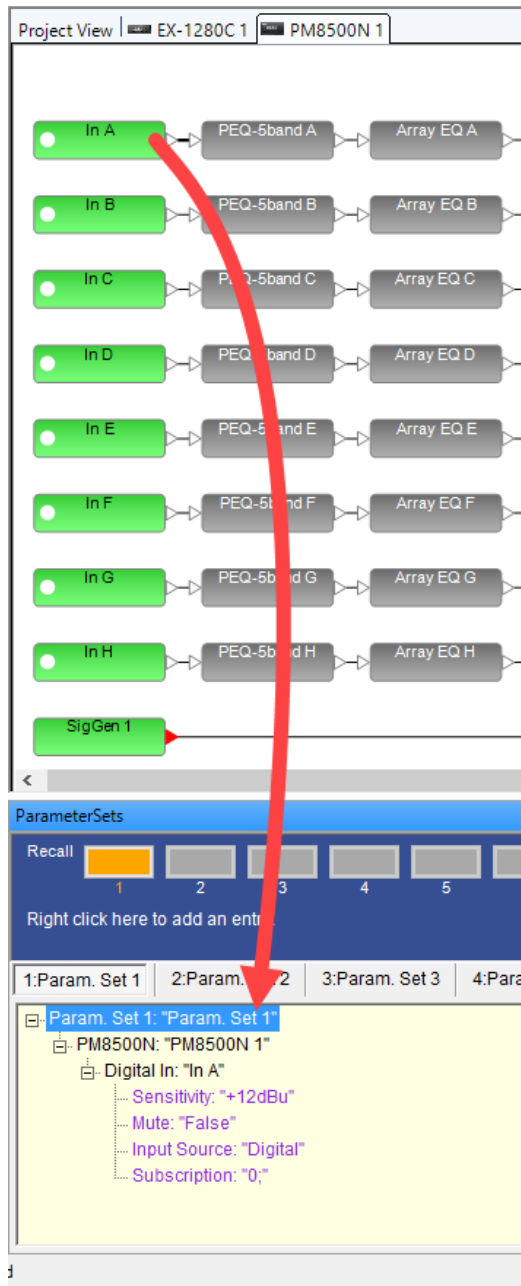

Dragging Dante Input into parameter sets for PowerMatch amplifiers

5. Once the Dante subscription is assigned into a parameter set, you may need to check the desired attributes of the parameter set. Expand the parameter set tree to reveal the input block parameters that were included in the drop package. Check that the correct Dante subscription is listed here. Select and delete other parameters that may not be required.

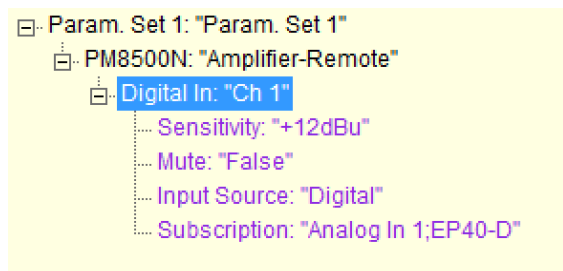

Example Parameter Set attributes

```

Param. Set 1: "Param. Set 1"
├── PM8500N: "Amplifier-Remote"
│   └── Digital In: "Ch 1"
│       └── Subscription: "Analog In 1;EP40-D"
    
```

Example Parameter Set attributes after removing non-required details

6. If desired, assign the desired parameter set(s) to user controls, timers, or serial input strings (see [Control Center Programming](#)).
7. Repeat procedure for creating different re-callable Dante subscriptions.

NOTE: Once the programming is complete, the design must be uploaded to the hardware. ControlSpace Designer must be online with the ControlSpace hardware to recall the routing. Otherwise, the parameter sets can be invoked via serial command or assigned Control Centers and GPI contacts.

Groups

Groups link the behavior of two or more similar signal processing blocks. Two types of groups exist:

- Grouped gains
- Grouped signal processing blocks

When gain controls are grouped together, they can be controlled together by a master fader. However, the relative gain offsets of group members are maintained. When you group signal processing blocks together (such as two parametric EQs), the settings are synchronized: changes to one block affect the others in the group. Up to 128 groups may be stored.

Creating a Group

Open the Groups window by accessing the Window Menu and selecting **Groups** from the list of available windows.

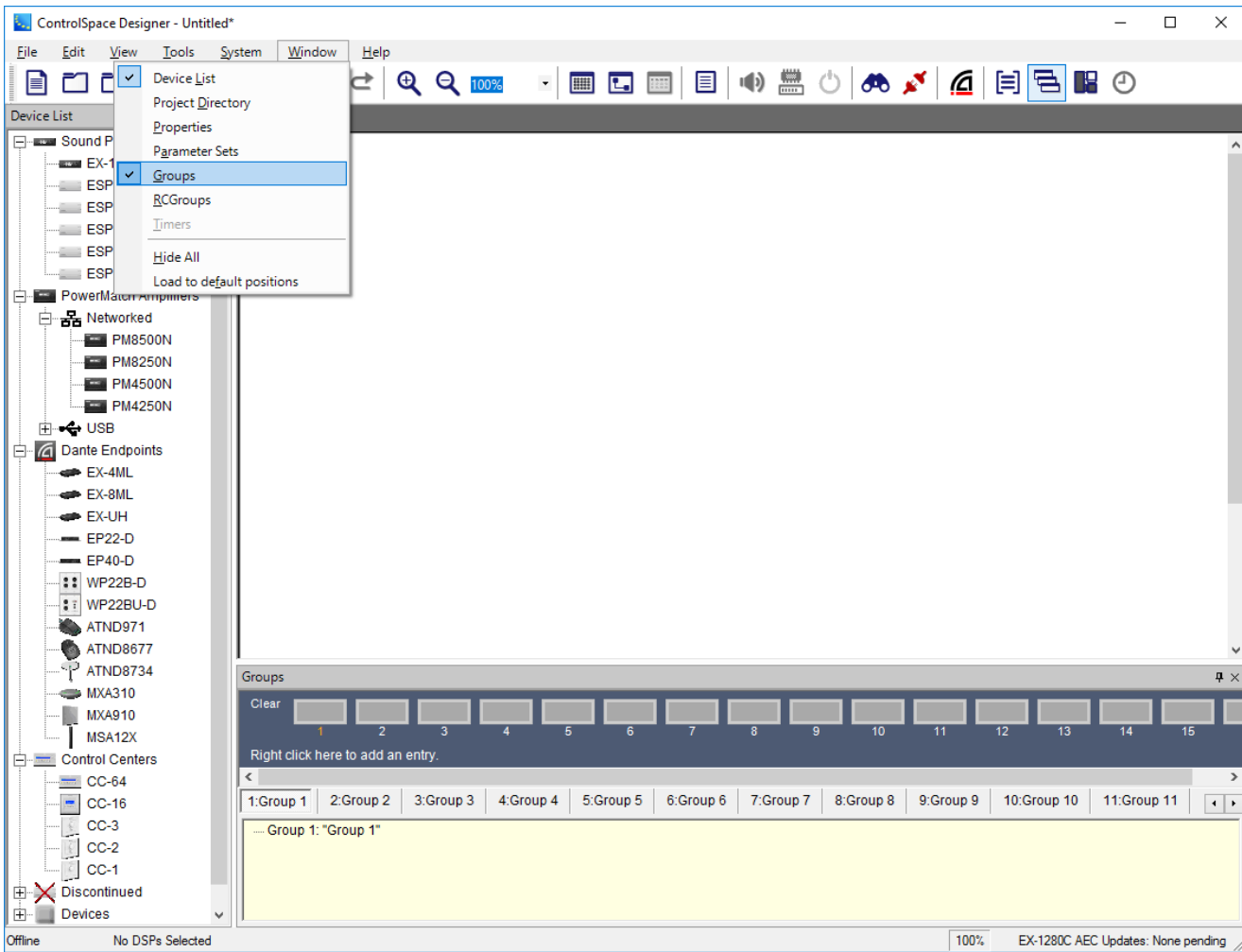

Groups window

Select the signal processing blocks in the Signal Processing View of the device whose functions you wish to group. Drag and drop those processing blocks onto a group name in the Groups window. Only processing blocks with identical functionality may be grouped together.

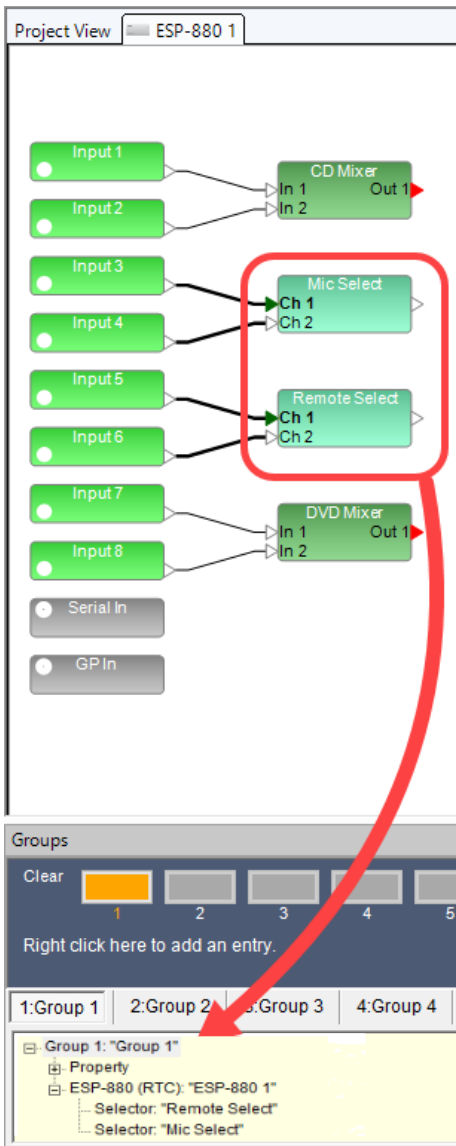

Dragging and dropping blocks into a group

When creating groups from processing blocks that contain gain controls, i.e., inputs, outputs, and gain blocks, you are prompted to choose the properties of the group you wish to create: Level + Mute, Level, or Mute.

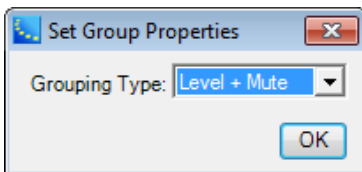

Set Group Properties

Grouped gains are automatically assigned a Master Fader control panel to adjust the level and mute functions chosen in the Set Group Properties panel. To access this Master Fader, right click on the group name and select **Master Fader**.

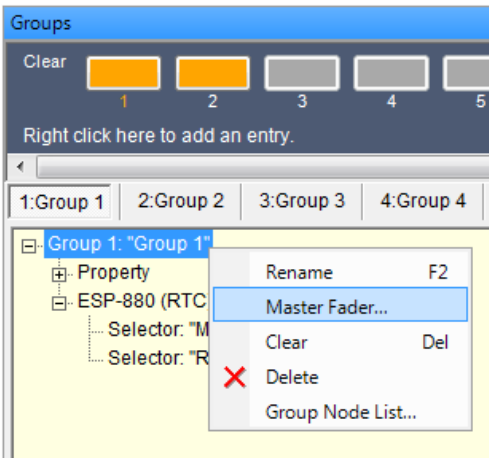

Access Group Master Fader

The appearance of each Master Fader type for Grouped Gains is shown below:

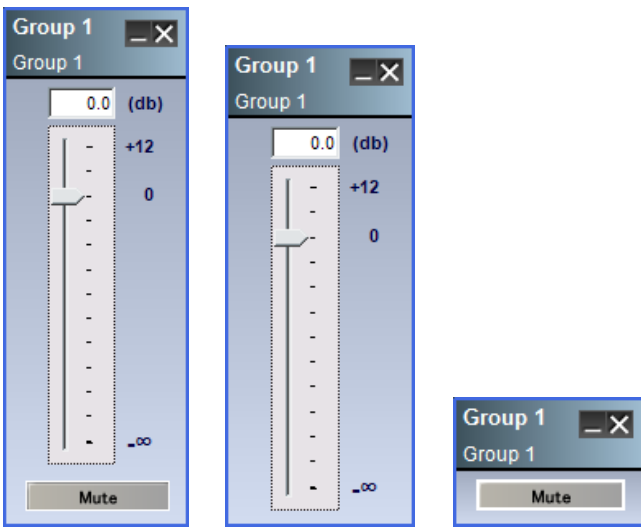

Level + Mute

Level

Mute

Verify correct behavior by opening the Master Fader, and each control panel for stored blocks. As you move the slider on the Master Fader you will see corresponding movement on the associated block gain sliders.

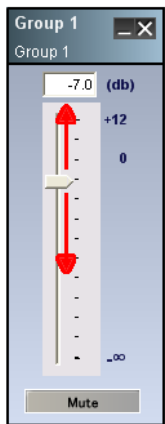

Individual gain sliders follow changes on Group slider.

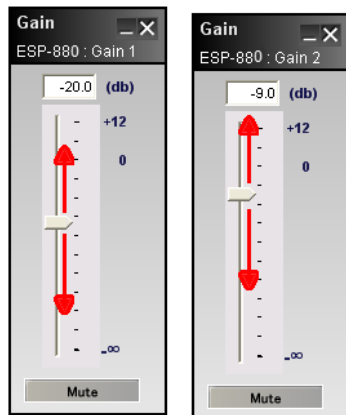

Verifying Master Fader changes on associated gains

NOTE: Grouped gain control sliders maintain relative positions when adjusting the Master Fader and you may adjust the level of an individual group member at any time. As the Master Fader is moved, an individual gain stops when it reaches its upper or lower limit, but the other gains in the group will continue to move. When the Master Fader is moved back, the relative gains are maintained as the stopped gain comes off its upper or lower limit.

When other signal processing block types (other than gain blocks) are grouped together, their settings are synchronized. Changes to one block automatically affect the others in the group. To create this type of group, select them in Signal Processing View then drag and drop them onto a group name in the Groups window.

Verify correct behavior by opening each control panel for blocks stored in the group. As you adjust elements within one block, you will see corresponding adjustments on all other associated blocks.

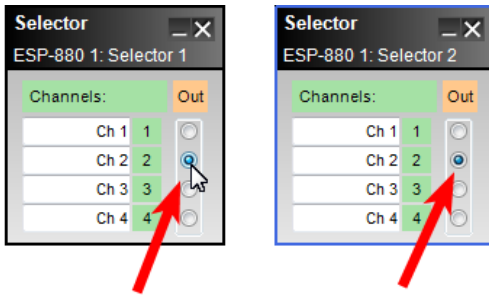

Selection made for Selector 1 is reflected on Selector 2.

Example of Synchronized Settings In Groups

Renaming a Group

To rename the Group, select the top level of the tree structure and press F2, or right click and choose **Rename**.

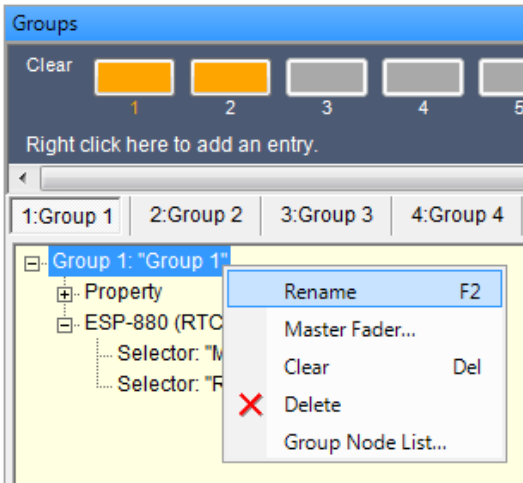

Renaming the Group

Editing Groups

If you need to change a group, view the contents by expanding the tree structure within the Groups window. The tree structure displays the blocks that are included in the group. Select a single block and right-click to open the block or to delete it from the group.

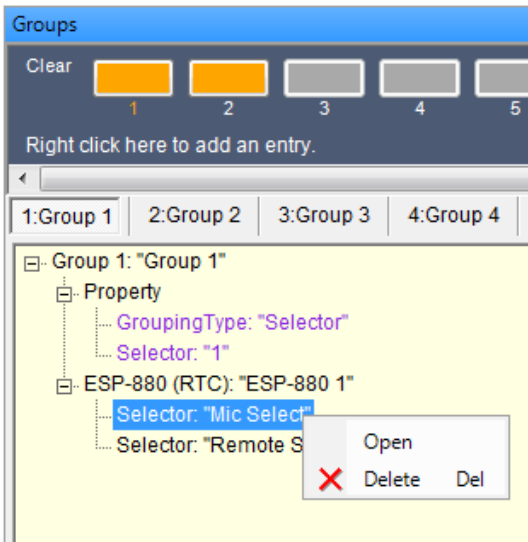

Editing the group

Adding Groups

The default quantity of groups is 16, but additional groups may be added.

To add more groups, right-click anywhere in the blue area where the **Right click here to add an entry** text is displayed. Then click the **Add Group** pop-up option to add a new group at the end of the list.

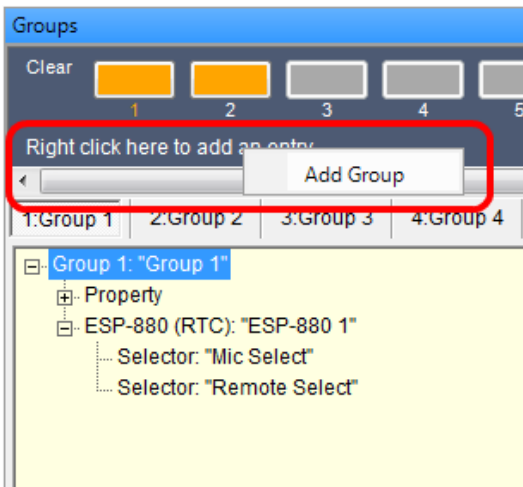

Adding a group

Clearing Groups

To clear the programming of a group, right-click on the top level of the group's tree structure, and select **Clear**. This removes the programming but leaves the group to be used again. You can also click the orange button to clear a group.

CAUTION: Selecting Delete removes the entire group and its programming. Deleting a group entirely could affect serial control programming with third-party devices.

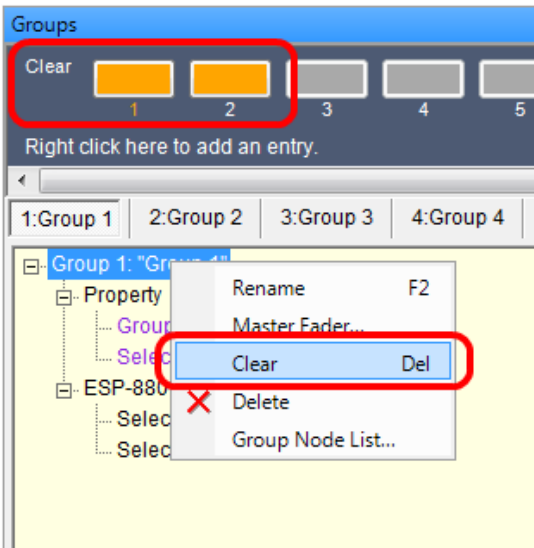

Clearing a Group

Group Node List

You can also create or modify a Group by using the Group Node List. Right click on the group name in the Groups window and choose **Group Node List**. The Group Nodes List window opens showing all signal processing nodes in your system.

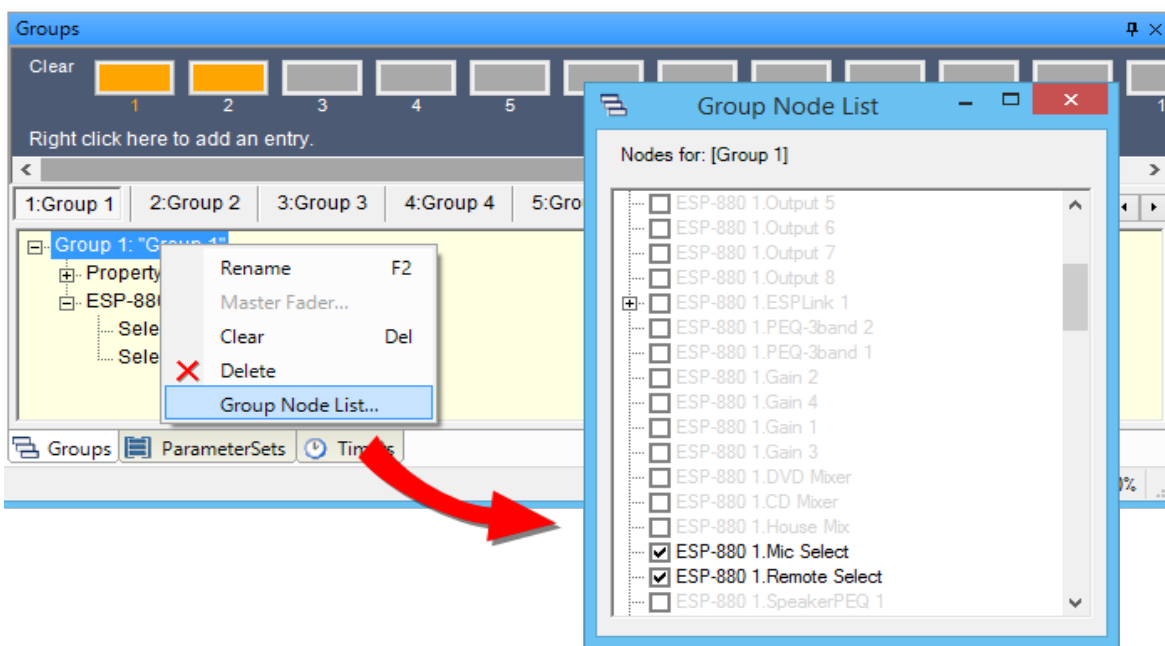

Opening the Group Nodes List

When creating new groups, you may add any processing block with identical functionality to that group. To select a processing block, place a check mark next to the block name as shown in the following figure.

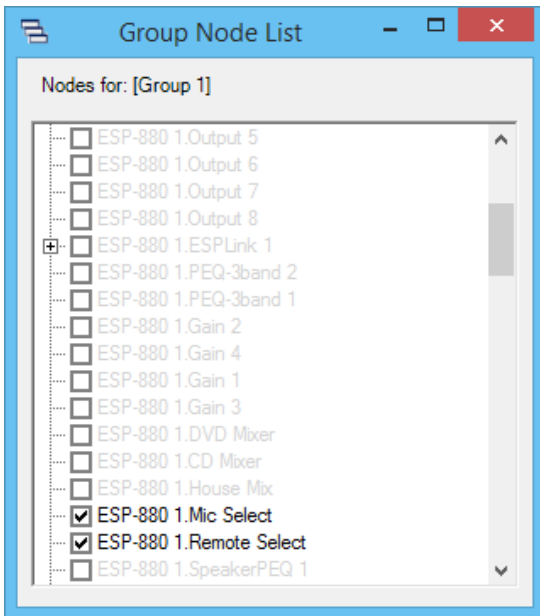

Select processing blocks for group association

RCGroups

An RCGroup is specifically used to configure combined rooms for conferencing by grouping Conference Room Routers, one per room. For more on how to use an RCGroup to combine rooms for conferencing, see [Configuring Combined Rooms](#).

Creating an RCGroup

Open the RCGroups window by accessing the Window Menu and selecting **RCGroups** from the list of available windows.

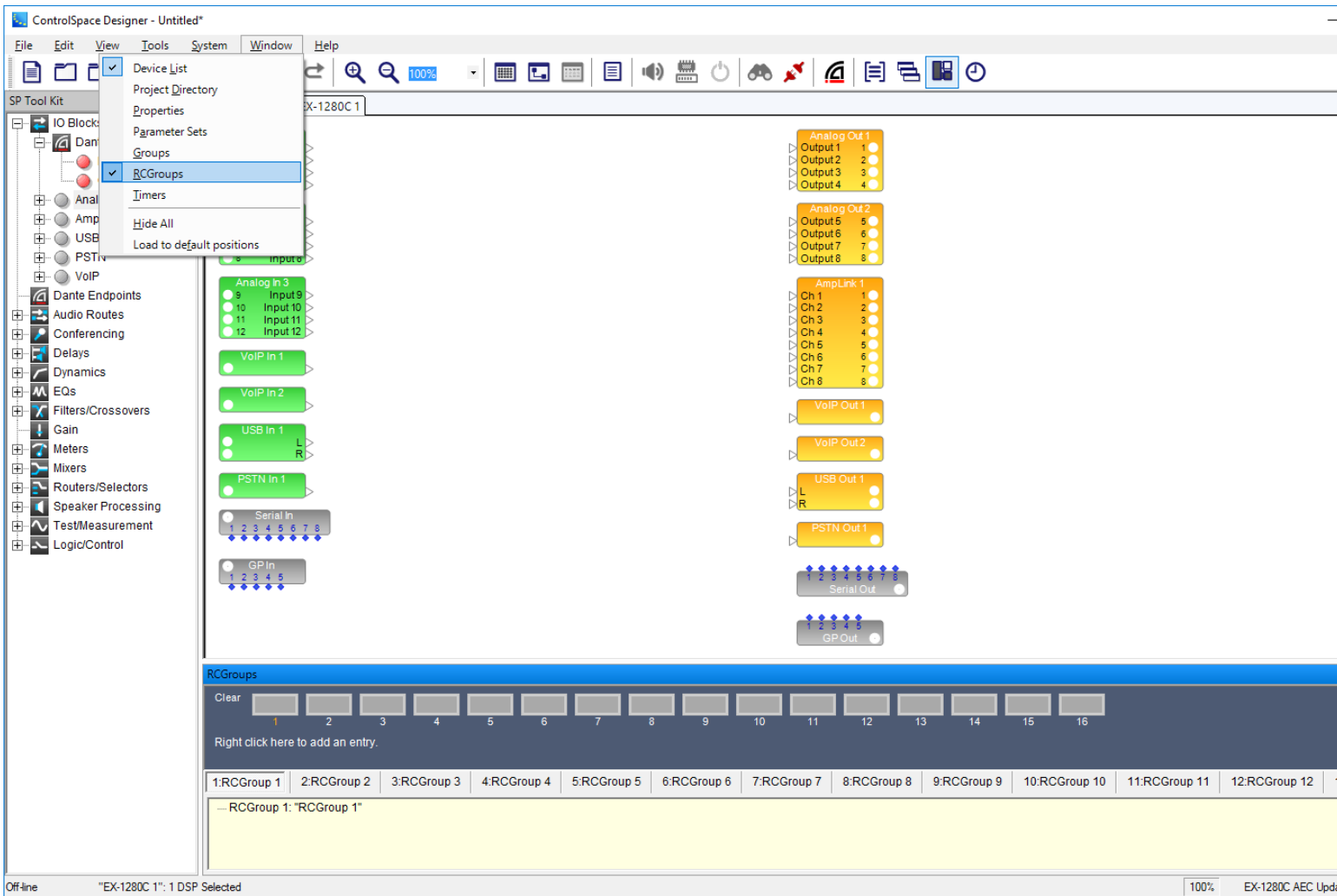

RCGroups window

Renaming an RCGroup

To rename the RCGroup, select the top level of the tree structure and press F2, or right click and choose **Rename**.

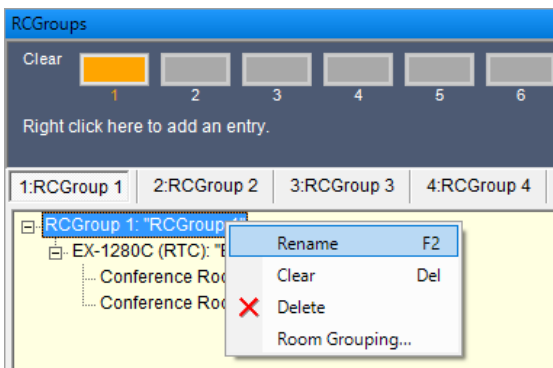

Renaming the RCGroup

Editing RCGroups

If you need to edit an RCGroup, view the contents by expanding the tree structure within the RCGroups window. The tree structure displays the blocks that are included in the RCGroup. Select a single block and

right-click to open the block's control panel or to delete the block from the RCGroup.

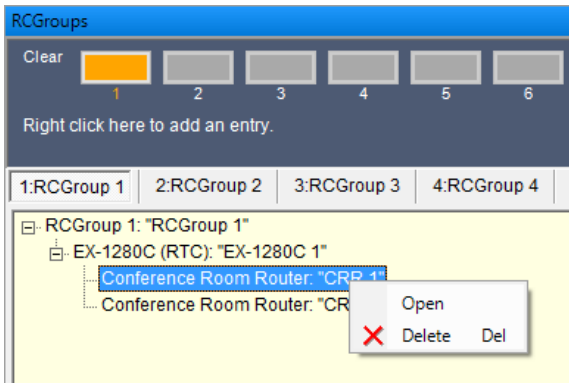

Editing an RCGroup

Adding RCGroups

The default quantity of RCGroups displayed in the window is 16, but additional RCGroups may be added. To add more RCGroups, right-click anywhere in the blue area where the **Right click here to add an entry** text is displayed. Then, click the **Add RCGroup** pop-up option to add a new RCGroup at the end of the list.

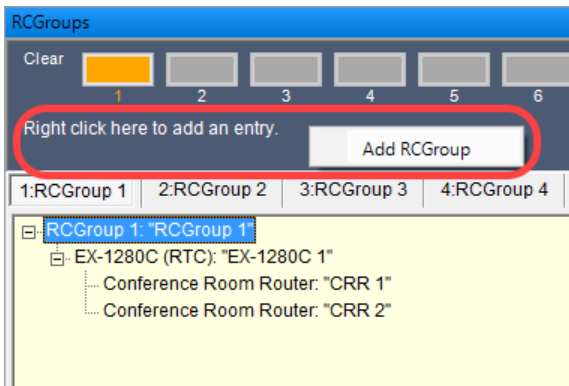

Adding an RCGroup

Clearing RCGroups

To clear the programming of an RCGroup, right-click on the top level of the RCGroup's tree structure and select **Clear**. Answer **OK** when asked if you want to clear the RCGroup. This removes the programming but leaves the empty RCGroup to be used again. You can also click the orange button to clear an RCGroup.

NOTE: Selecting Delete removes the entire RCGroup and its programming.

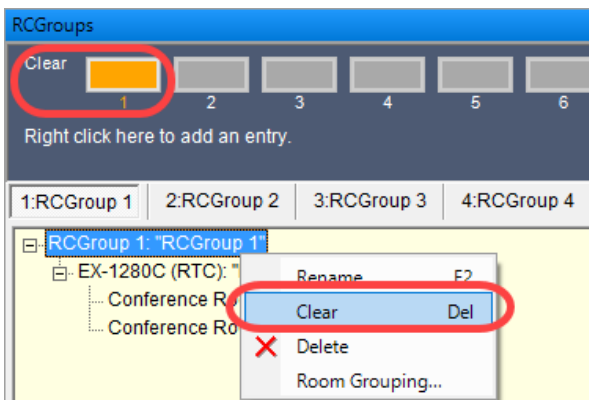

Clearing an RCGroup

Timers

Timers can be used to schedule changes that will occur in signal processing or control settings at pre-determined times. You can schedule a change to take place on a specific date and time, at the same time every day, or at a time on specific days of the week. For example, you could schedule a change in a source selector to take place every day at 5:00 PM.

The sound processor system time, upon which a timer is based, is set when a configuration file is loaded or when the system is flashed on disconnect. That processor's system time is derived from the current computer setting and includes time, date, time zone, and daylight savings information.

NOTE: Timers are not supported in PowerMatch-only designs.

Creating a Timer

Open the Timers window by accessing the Window Menu and selecting **Timers** from the list of available windows. The Timers tab is displayed in the Control Library. 16 timers are available for use.



Timers window

In Signal Processing View, select the signal processing blocks whose functions you wish to include in a timer. Drag and drop those processing blocks onto a timer name in the Timers window.

NOTE: Analog or Dante inputs, analog or Dante outputs, ESPLink outputs, AmpLink outputs, **gains, and selectors** are the only processing blocks that may **be added directly to timers. Changes to other processing blocks may be made by using parameter sets.**

To program a new timer function:

1. Configure the signal processing objects that you want changed when the timer triggers.
2. Drag and drop the signal processing objects onto a timer name in the Timers window.

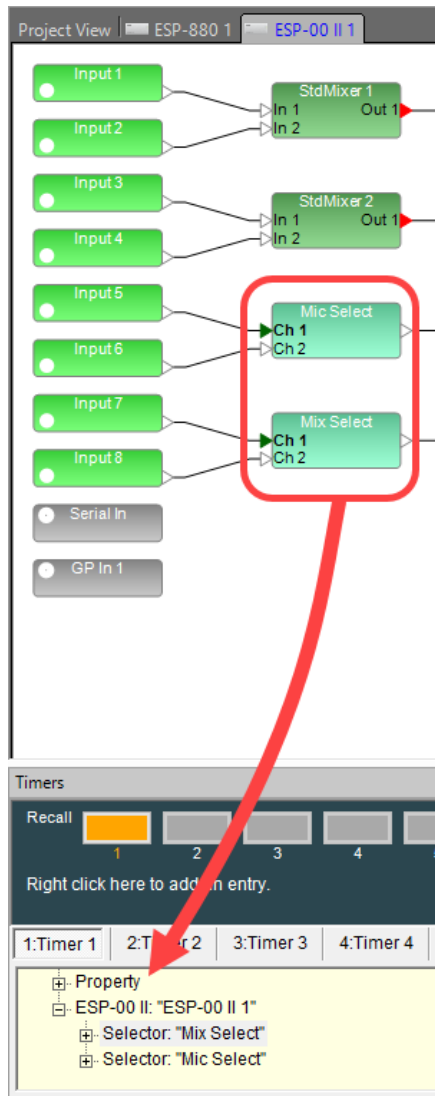

Dragging and dropping blocks into a timer

3. Define the timer's occurrence.

Only Once

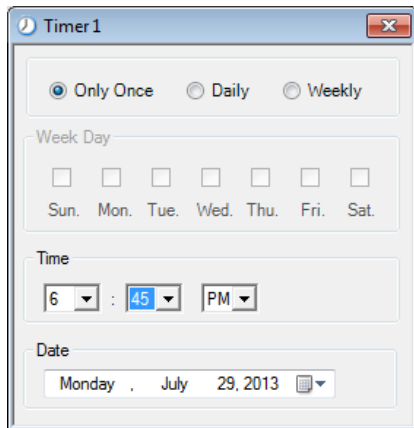

Daily

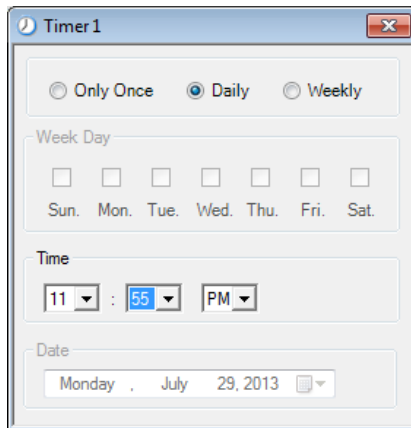

Weekly

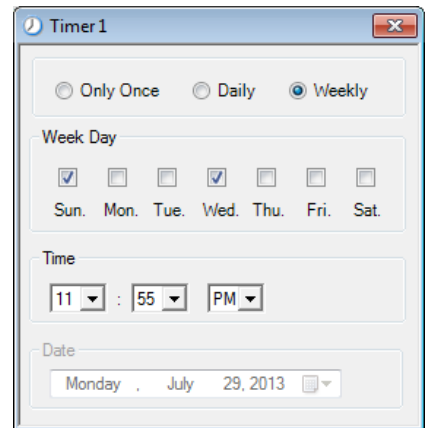

Timer Control Panel Types

4. Test the newly programmed timer.

When more signal processing objects are added to a timer, the timer setup window is displayed. Select one of three timer types (Only Once, Daily, or Weekly) and then choose the remaining options available for that specific timer type.

Editing a Timer

To modify an existing timer, view its contents by expanding the tree structure within the Timers window. The tree structure displays the processing blocks included in the timer. Select a single block and right-click to open the block or to delete it from the group.

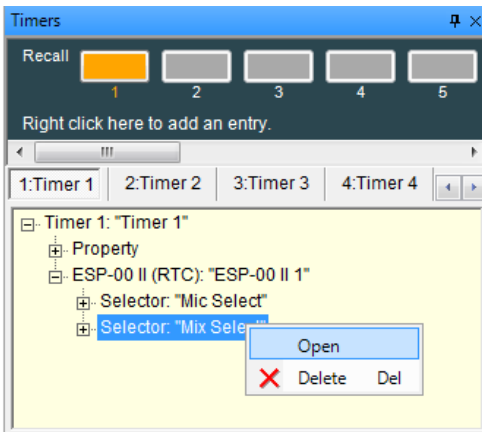

To adjust the occurrence of a timer, right click on the timer name and select **Set Date Time...** .

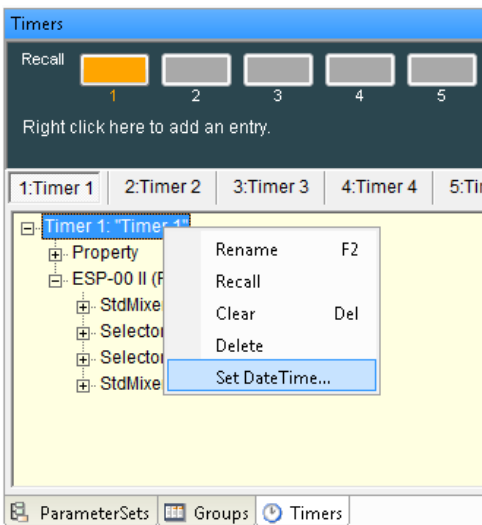

Adjusting date and time of a timer

Renaming a Timer

To rename the timer, select the top level of the tree structure and press F2, or right click and choose **Rename**.

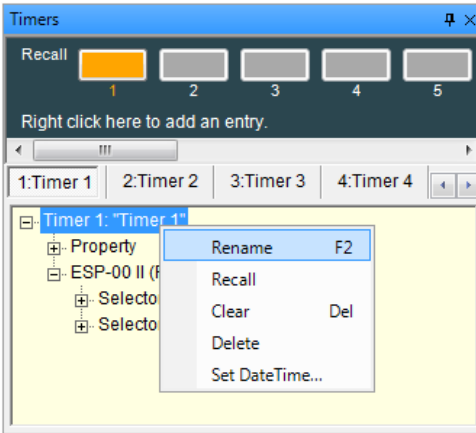

Rename a timer

Recalling Timers

A **Recall** button in the Timers window changes to orange when a timer is stored. Pressing the **Recall** button changes the state of all signal processing blocks to the values stored in the timer. You can also recall a timer by right clicking on the timer and selecting **Recall**.

You can open the individual signal processing block control panels and then recall timers to verify that correct settings are stored.

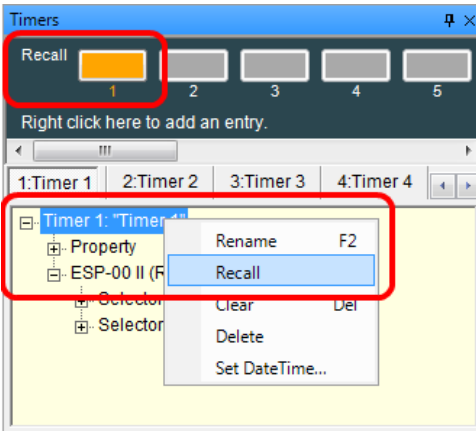

Recall a timer

Clearing Timers

To clear the programming of a timer, right-click on the top level of the timer's tree structure, and select **Clear**. This removes the programming but leaves the timer to be used again.

NOTE: Selecting **Delete** removes the timer and its programming.

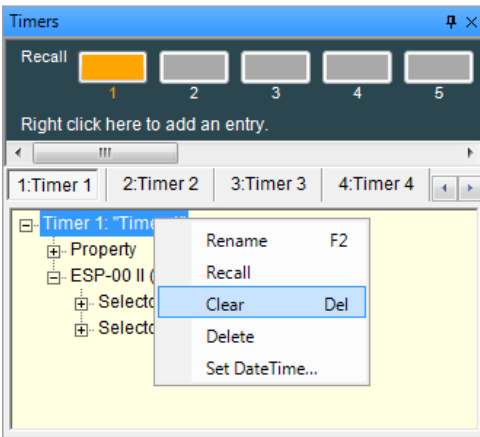

Clearing a timer

Programming With Composite Device Blocks

Some multi-channel devices are represented in the Signal Processing view by a composite device block. When programming Parameter Sets, Groups, and Timers with these types of devices you have the option of selecting individual channels.

NOTE: This option also exists for Serial OUT and GP OUT functions.

Examples:

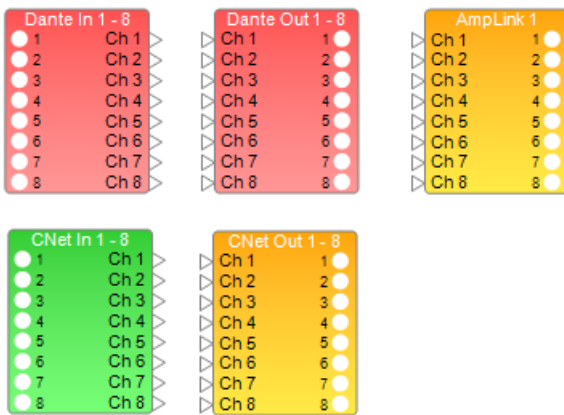

Composite device blocks

For example, when you drag and drop eight Dante output channels to a parameter set, a pop-up dialog give you the option of selecting the channels you want to assign to it.

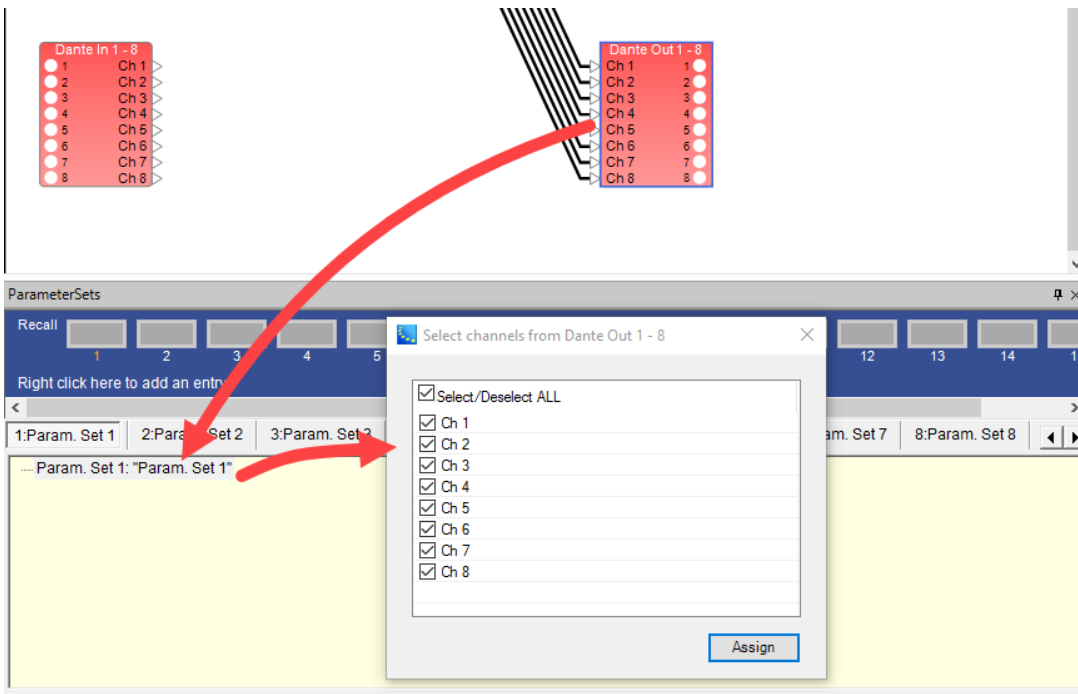

Dragging a composite block into a parameter set

If you select two channels and click **Assign**, only those channels will appear in that parameter set.

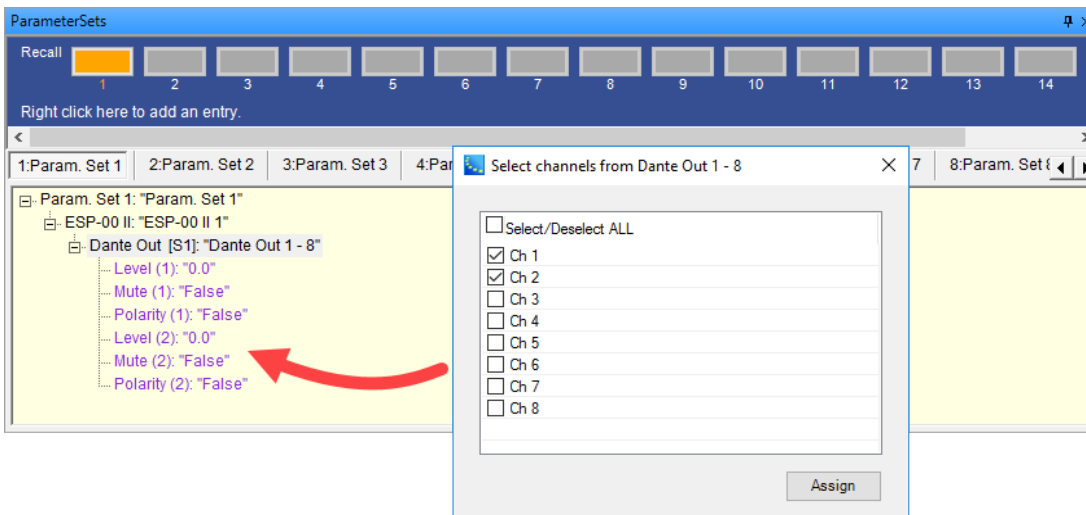

Selecting channels for a composite device

In the parameter set, if you open the Parameter Set Node List you will see only those Dante output channels selected.

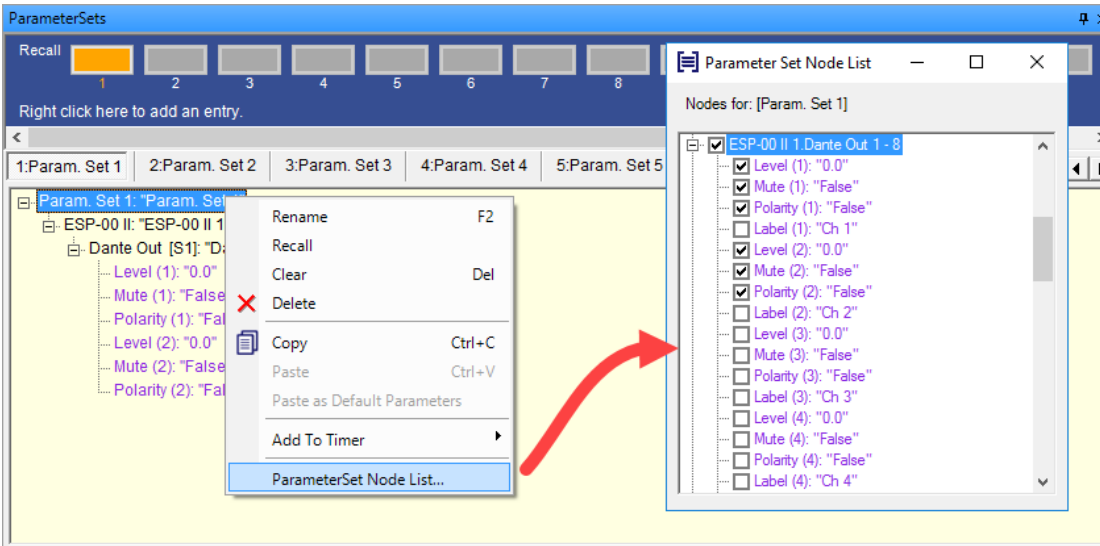

Composite device channels in Parameter Set Nodes List

GPIO Programming

Programming GPIO

Programming GPIO ports within an ESP or EX-1280C system is accomplished using the same drag and drop methods described for all other signal processing and control programming. However, the source and destination of the drag and drop operations, as well as programming logic of the two types of ports, are reversed.

For more information on GPI and GPO control panels, see:

[ESP-00 II GPIO](#)

[ESP-880/1240/4120/1600 GPIO](#)

[EX-1280C GPIO](#)

General Purpose Inputs (GPI)

With GPIs, system devices are programmed to respond to voltage changes from external equipment connected to a GPI port. See [Programming GPI](#) for programming information.

External Potentiometers and Switches

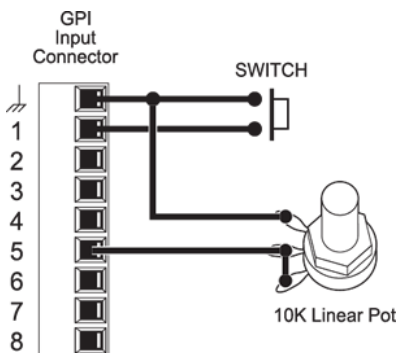

Typical GPI Device Connections Example

General Purpose Outputs (GPO)

With GPOs, internal system design changes affect the voltage supplied to GPO ports for driving external equipment. See [Programming GPO](#) for programming information.

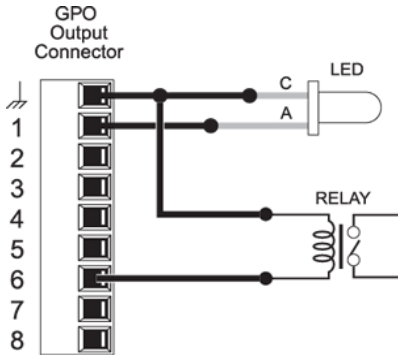

Typical GPO Device Connections Example

Programming GPI

Set the GPI port operating mode, then drag and drop processing blocks from the Signal Processing View or Control Library into the text lines in the programming tree of the GPI control panel.

NOTE: ESP-880 is used as an example, but programming is similar for other sound processors.

For more information on GPI control panels, see:

[ESP-00 II GPIO](#)

[ESP-880/1240/4120/1600 GPIO](#)

[EX-1280C GPIO](#)

Analog Mode

To program an Analog GPI port mode with a potentiometer connected to GPI port 1 to control a gain stage, adjust the GPI mode to **Analog** then drag the gain block onto "Analog Control Input 1:"

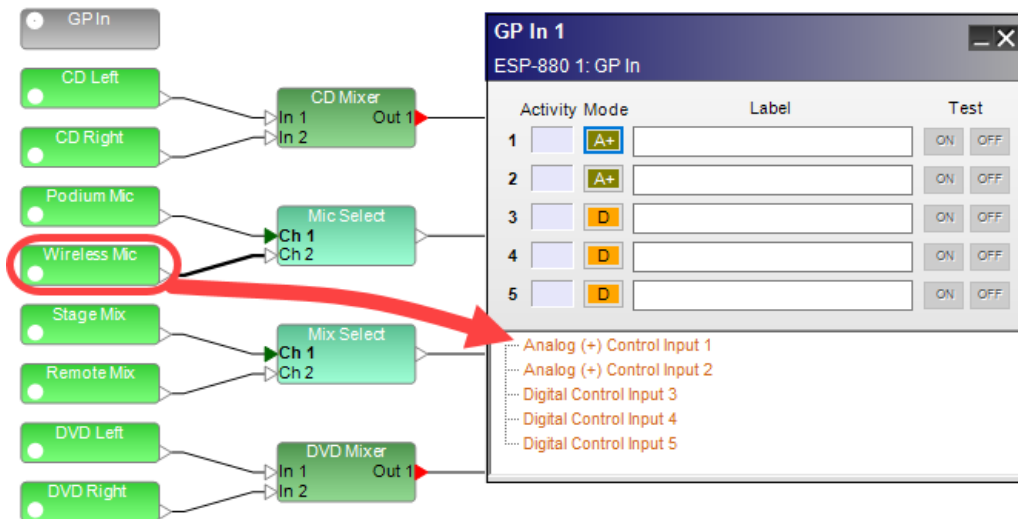

Assigning an input gain block to an Analog GPI port

Testing the operation of this GPI programming within software is accomplished by opening the input gain control panel and right clicking the ON test button next to the GPI control panel operating mode button to gain access to a virtual test slider.

Move the test slider up and down to verify corresponding movement occurs on the gain control. When physical hardware is present and connected, you will see similar movement on the gain control by rotating the potentiometer in the field.

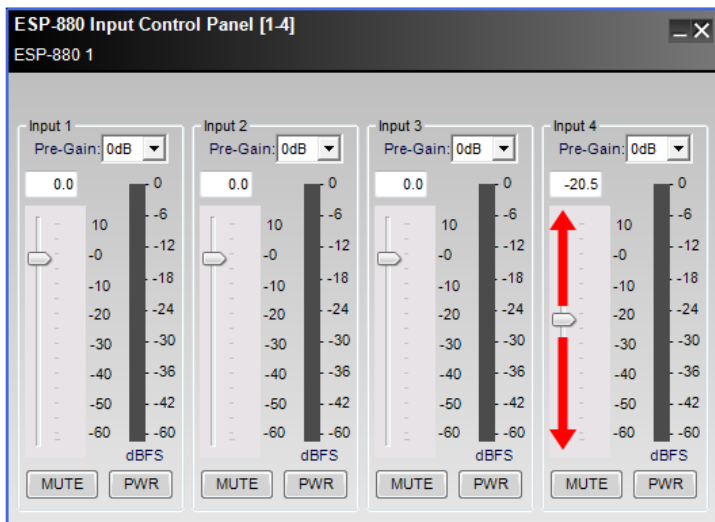
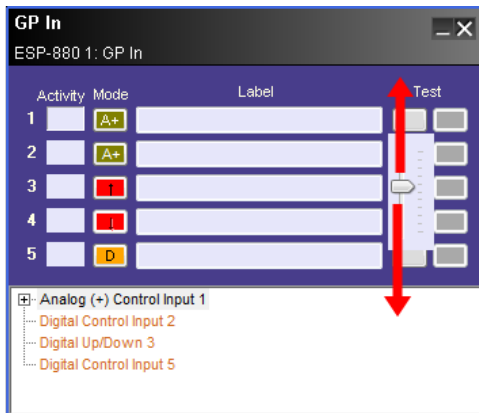

Testing Analog GPI port programming

Digital Mode

To program a Digital GPI port mode with a latching closure connected to GPI port 2, adjust the GPI mode to **Digital** then drag a selector to "Digital Control Input *n*." This GPI mode stores two Snapshot conditions to match normally open and normally closed switch conditions. Close the Snapshot Set Mode panel after the first drag operation to define the ON condition, adjust the selector to the alternate position, then drag and drop the selector back on to "Digital Control Input 2:" This becomes the Snapshot Set Mode OFF condition.

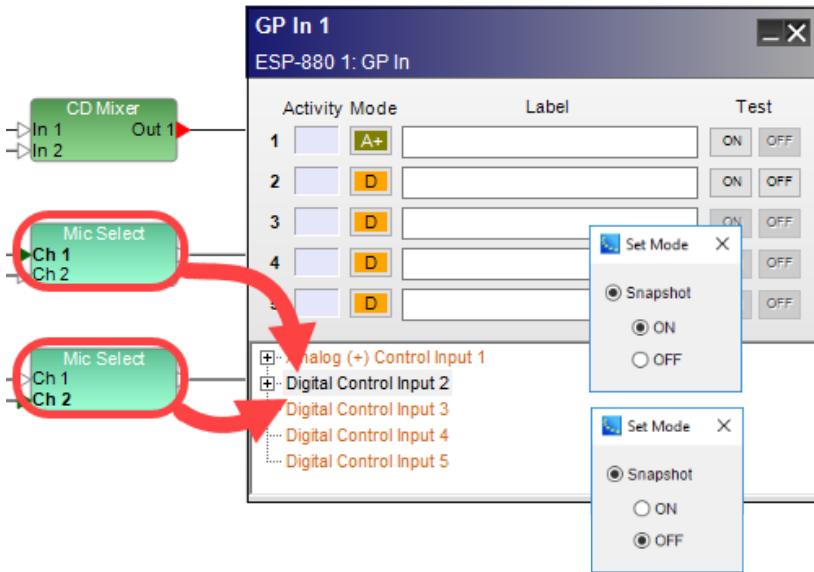

Assigning a selector block to a Digital GPI port

Testing the operation of this GPI programming within software is accomplished by viewing the selector control panel while left clicking the test buttons next to the GPI control panel operating mode button to simulate switch actions.

Push the ON test button to verify corresponding movement occurs in the selector. Repeat this to verify selector for the OFF test button. When physical hardware is present and connected, you will see similar movement on the selector by activating the switch in the field.

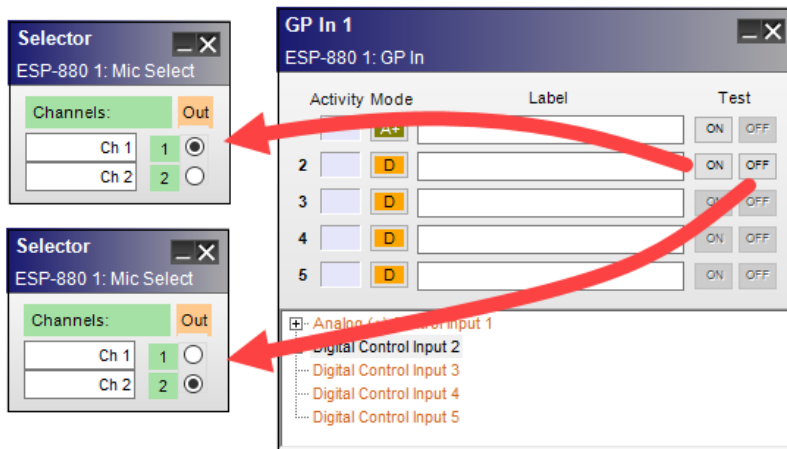

Testing Digital GPI port programming

Digital Up/Down Volume Mode

To program a Digital Up/Down Volume GPI port mode with two momentary switches connected to GPI ports 3 & 4, adjust the GPI mode to **Digital Up/Down** then drag a gain block onto "Digital Control Input 3." Digital Up/Down Volume mode replicates rotary gain control movement with one push button to increase level and another to decrease level. As a result, this mode occupies two positions in the GPI control panel.

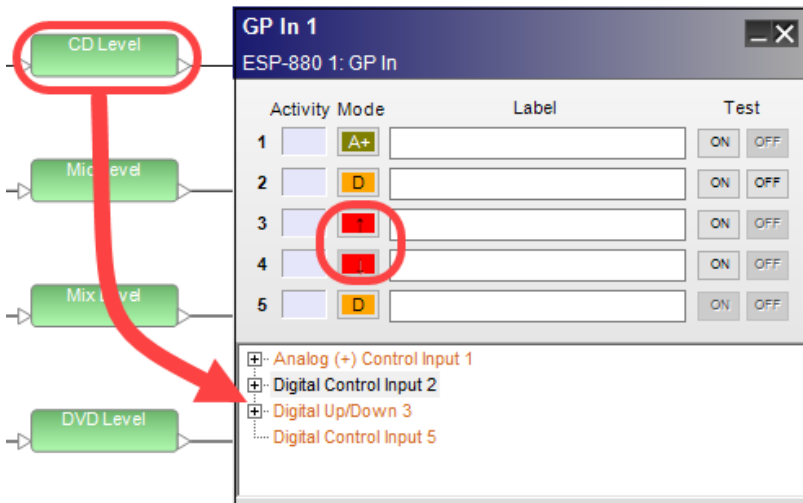

Assigning a gain block to a Digital Up/Down Volume GPI port

Testing the operation of this GPI programming within software is accomplished by opening the input gain control panel and left clicking the ON test buttons next to the GPI control panel operating mode buttons to simulate switch push button actions.

Press the ON test buttons repeatedly to verify corresponding movement occurs on the gain control in the input control panel. When physical hardware is present and connected, you will see similar movement on the gain control by pushing the physical buttons in the field.

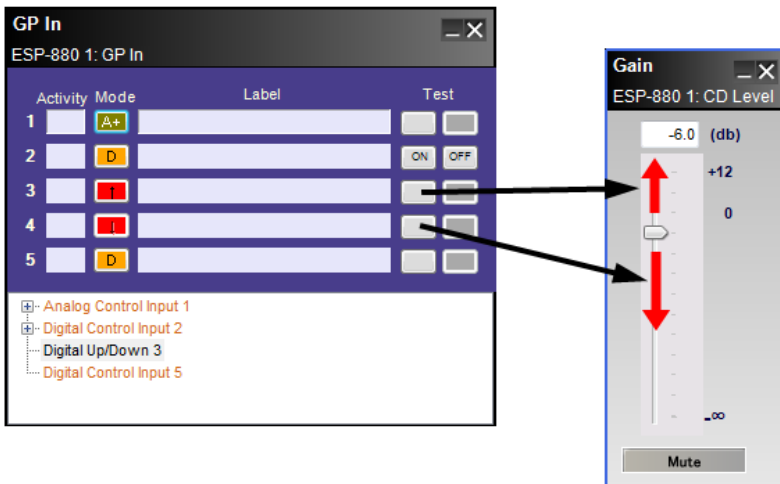

Testing Digital Up/Down Volume GPI port programming

Digital Discrete Mode

Digital Discrete mode only applies to the mute state of a gain block or to gain blocks in a group. This special digital mode allows simplified programming for various muting types.

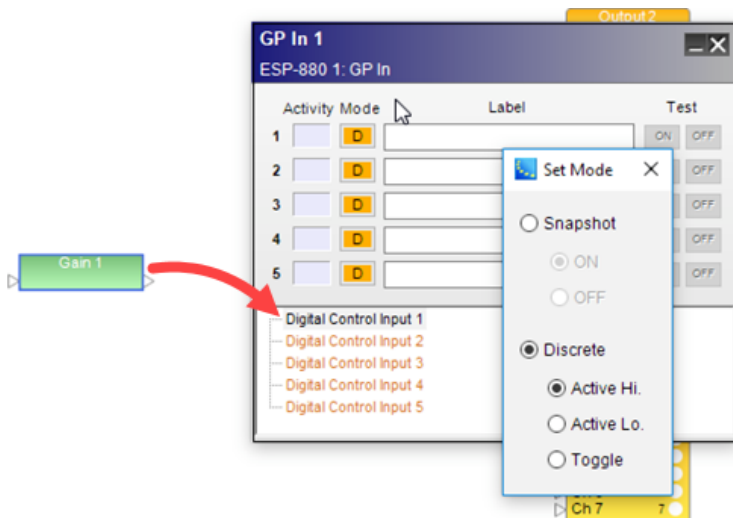

Digital discrete mode - muting types

When you drag a gain block or grouped gains to a "Digital Control Input n ," you are prompted to select and apply one of the following Discrete modes:

Active Hi - signal is normally muted. Unmutes the signal when the GPI is ON (or closed). **Example:** Paging mic where audio is only on when the mic button is pushed.

Active Lo - signal is normally unmuted. Mutes the signal when the GPI is ON (or closed). **Example:** Mic audio is normally on until a muting button is pressed. It stays muted until the button is released.

Toggle - signal mute alternates ON and OFF when the GPI is momentarily pulsed ON (OFF>ON>OFF).

Programming GPO

General Purpose Outputs are activated by parameter set or timer and two methods exist for programming them. The first method is to use the Project Directory and the second method is to use the Parameter Set Nodes List.

For each of the two methods, the first step is to open the GPO control panel and set the state of the desired output to either ON or OFF.

NOTE: ESP-880 is used as an example, but programming is similar for other sound processors.

For more information on GPO control panels, see:

[ESP-00 II GPIO](#)

[ESP-880/1240/4120/1600 GPIO](#)

[EX-1280C GPIO](#)

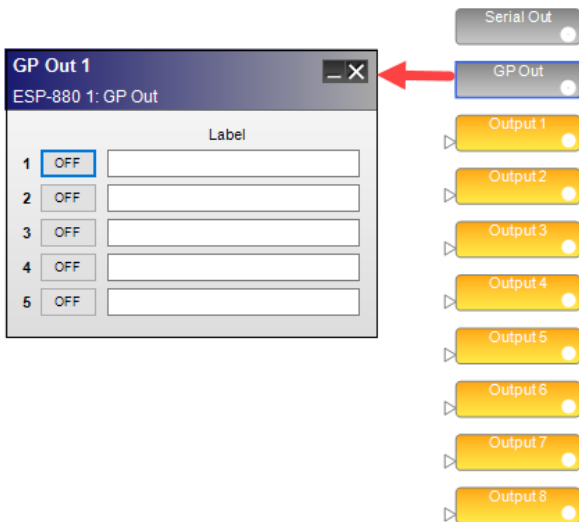

Open & enable General Purpose Outputs

Using the Project Directory

Using the Project Directory, expand the GPO section within the ESP or EX-1280C device tree and drag the specific output of interest into a parameter set or timer. When that parameter set is invoked or the timer activates, the GPO will change its state to the programmed value (ON or OFF).

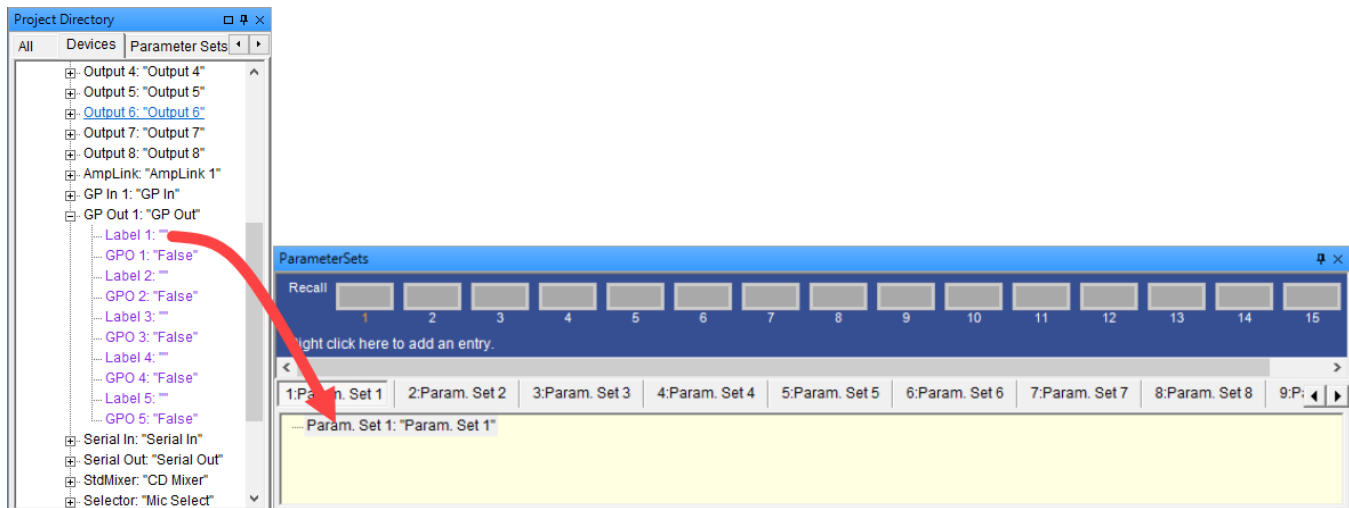

Project Directory GPO drag & drop to parameter set

Using the Parameter Set Nodes List

Right click on a parameter set name in the Parameter Set window and select the Parameter Set Nodes List. Place a check mark next to the desired GPO ports in the ESP or EX-1280C device tree to store in the parameter set.

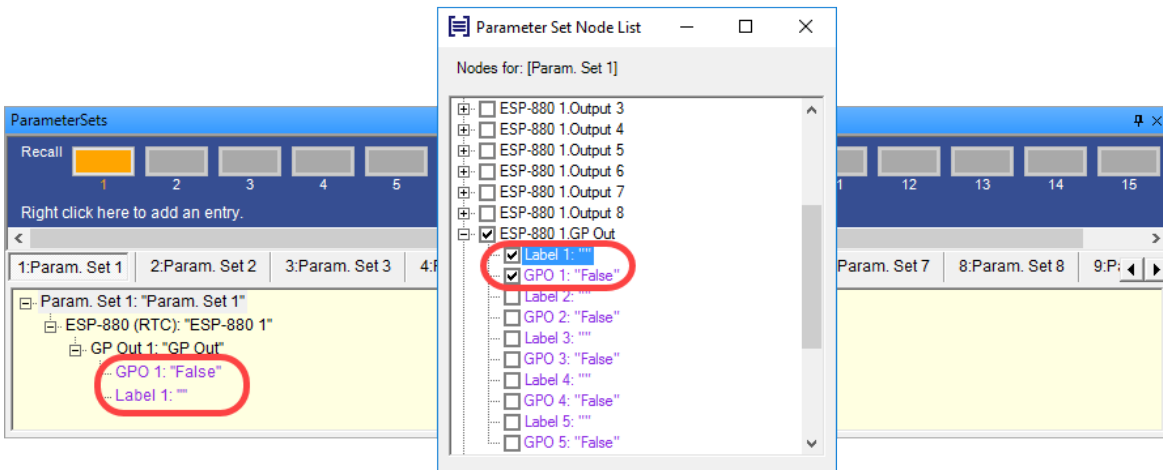

Parameter Set Node List GPO programming

Serial Port Programming

ControlSpace[®] sound processors will respond to and send serial messages via either the serial port or the Ethernet network.

Baud rate, bit length, and parity are all **configurable** for the serial port on ESP or EX-1280C processors.

Serial inputs may be programmed to invoke an action in a device when a serial command is received from an external device. Serial outputs may be programmed to send a serial command to an external device when a parameter set is invoked, or when a timer activates.

Serial Inputs

ControlSpace ESP or EX-1280C sound processors can recall settings of signal processing blocks or invoke a parameter set when a serial string is received from the RS-232 serial port. To program a serial input, open the **Serial In** control panel from Signal Processing View and drag and drop one or more blocks or parameter sets into a "Serial Input *n*" line in the programming tree.

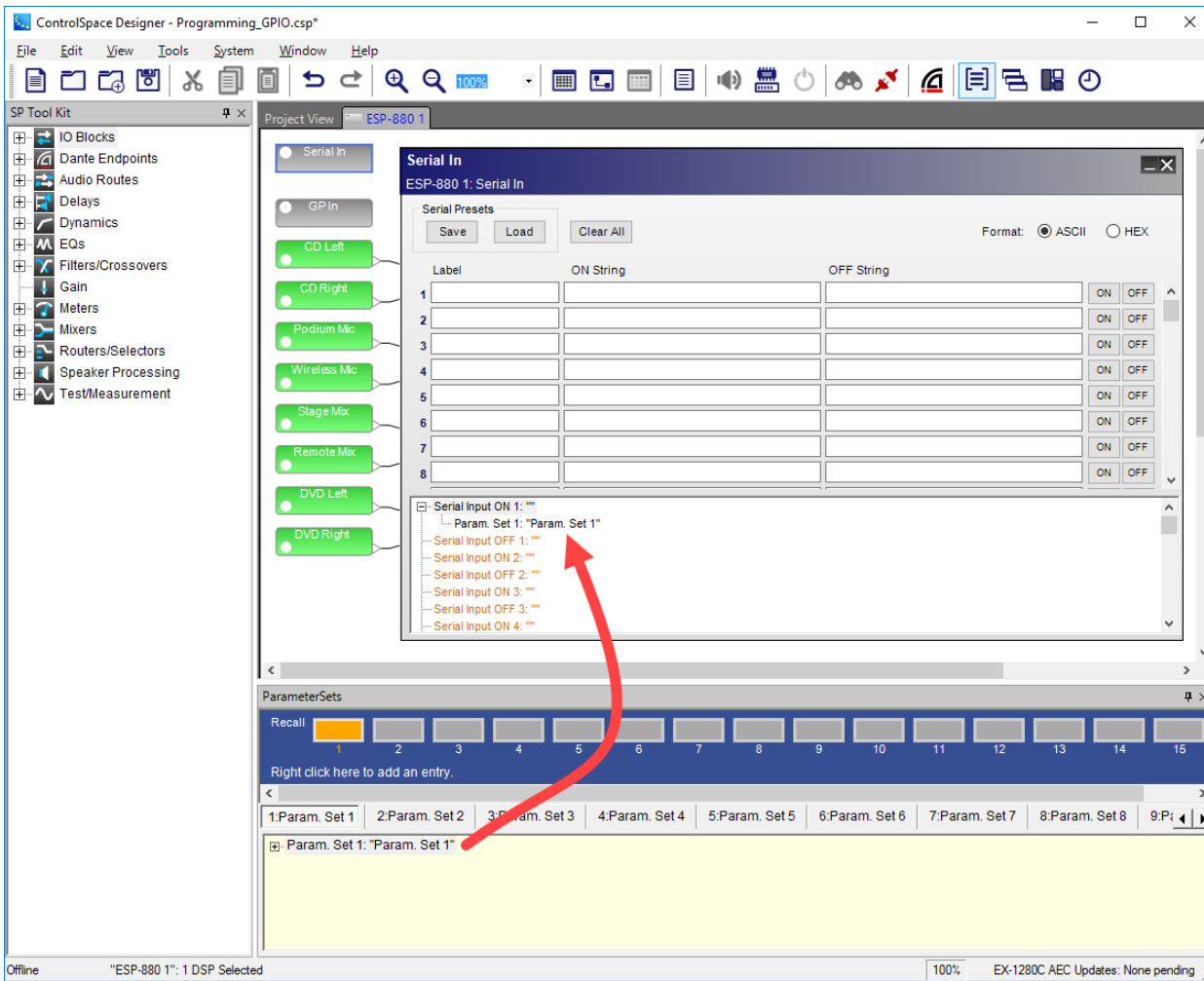

Dragging parameter set into Serial In programming tree

Enter the serial string of characters in the corresponding field in the upper half of the control panel. When an incoming serial string matches any of the strings entered, the block or parameter set programmed for that string is invoked. For example, if a string is received from an external system that matches serial input string #1, that will invoke the block or parameter set in SerialInput1 in the lower half of the control panel.

Test buttons test the programming string for a specified ON or OFF state of a serial input, respectively. If no target is assigned to the serial string, the ON or OFF button is disabled. Serial input ON and OFF buttons are only active when online.

Serial Outputs

The serial output device is used to transmit a serial string out of the serial port when a parameter set is invoked, or when a timer activates.

To open the Serial Output control panel, double-click on the **Serial Out** block in Signal Processing View.

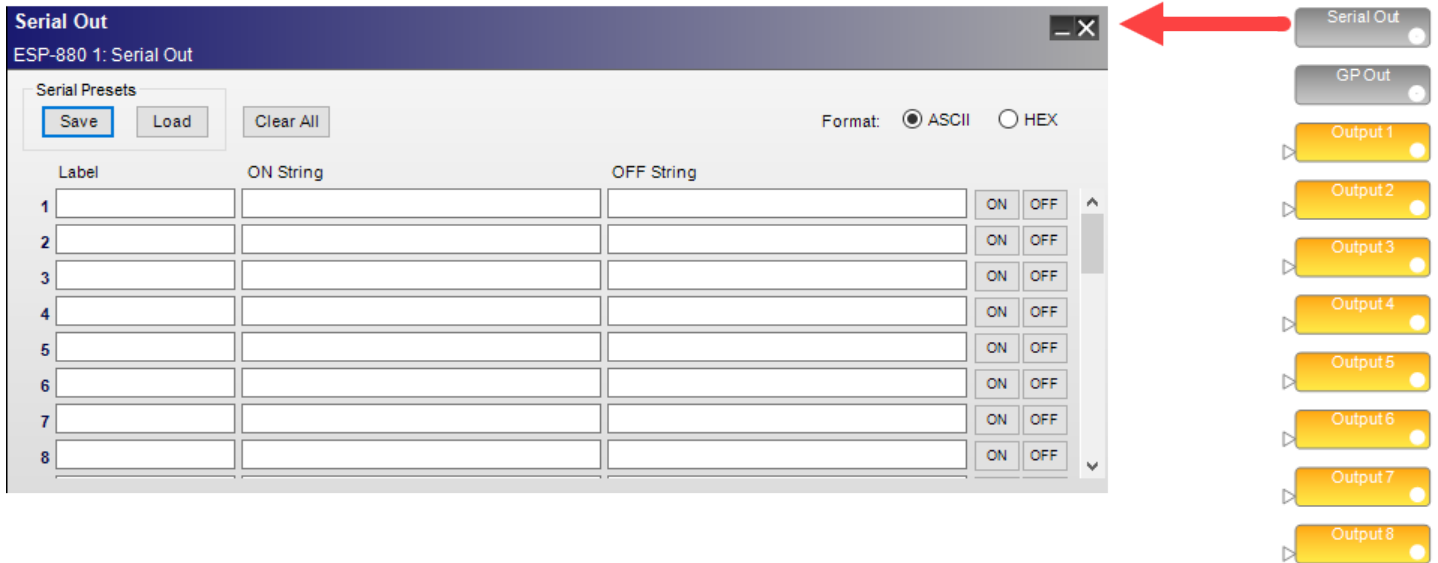

Opening the Serial Output control panel

There are two ways to program a Serial Output:

- Use the Project Directory
- Use the Parameter Set Nodes List

For each of the two methods, the first step is to open the **Serial Out** control panel and enter the serial command strings to provide the desired device control.

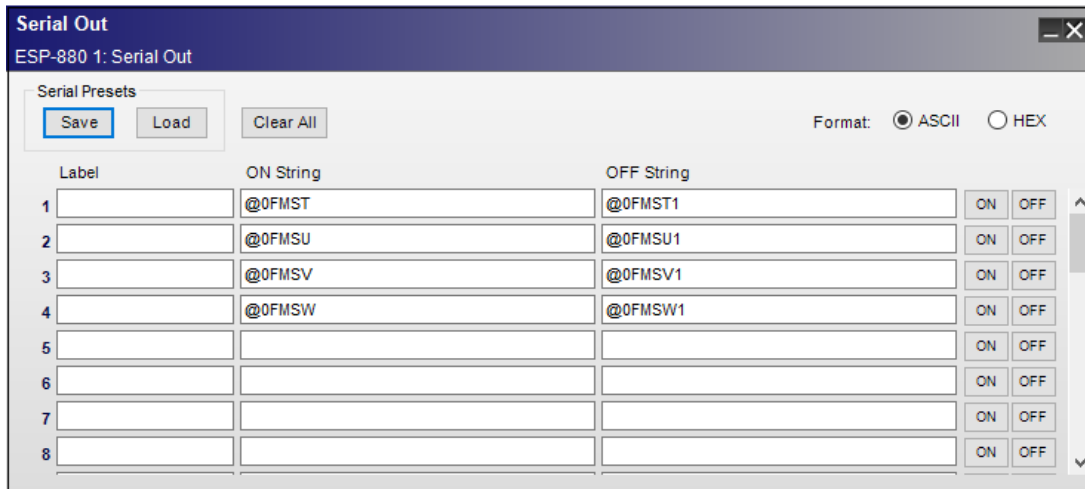

Serial output strings

Using the Project Directory

After typing the serial string or command into the Serial Output control panel, find the Serial Output in the Project Directory, and drag it into a parameter set or timer. When the parameter set is invoked, or the timer activates, the Serial string is sent out the Serial port on the sound processor. For example, you could send a signal to a video switcher when a parameter set is invoked or a timer expires.

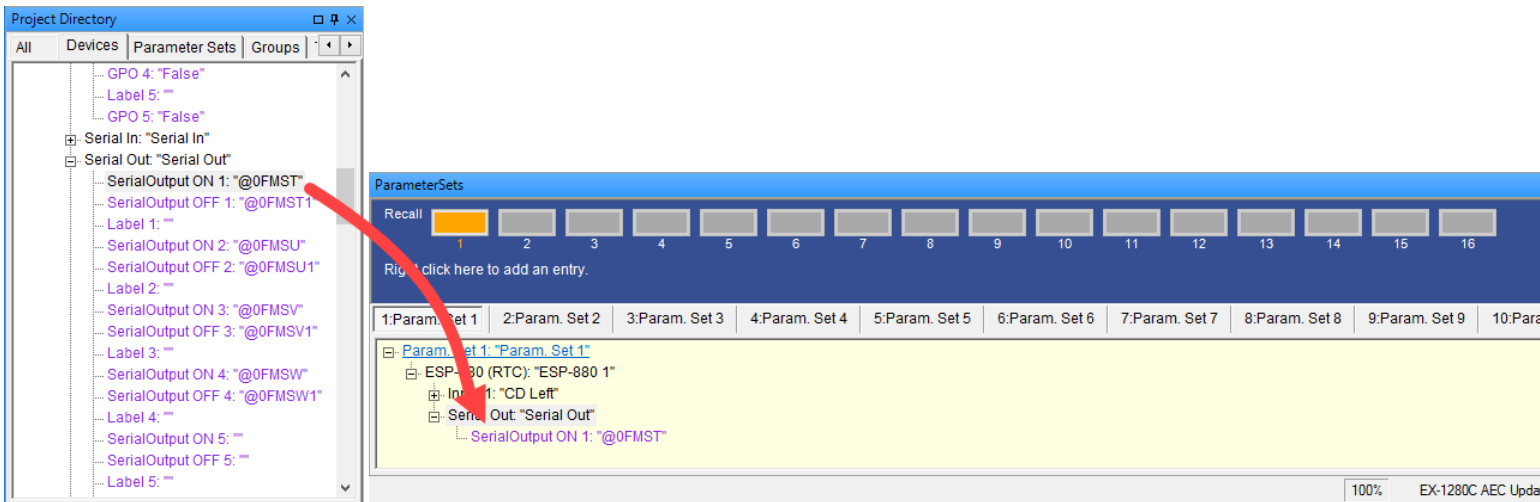

Using Project Directory to program serial output

Using the Parameter Set Node List

Right click on a parameter set name in the Parameter Set window and select **Parameter Set Node List**. Place a check mark next to the desired serial output ports in the sound processor's device tree to store in the parameter set.

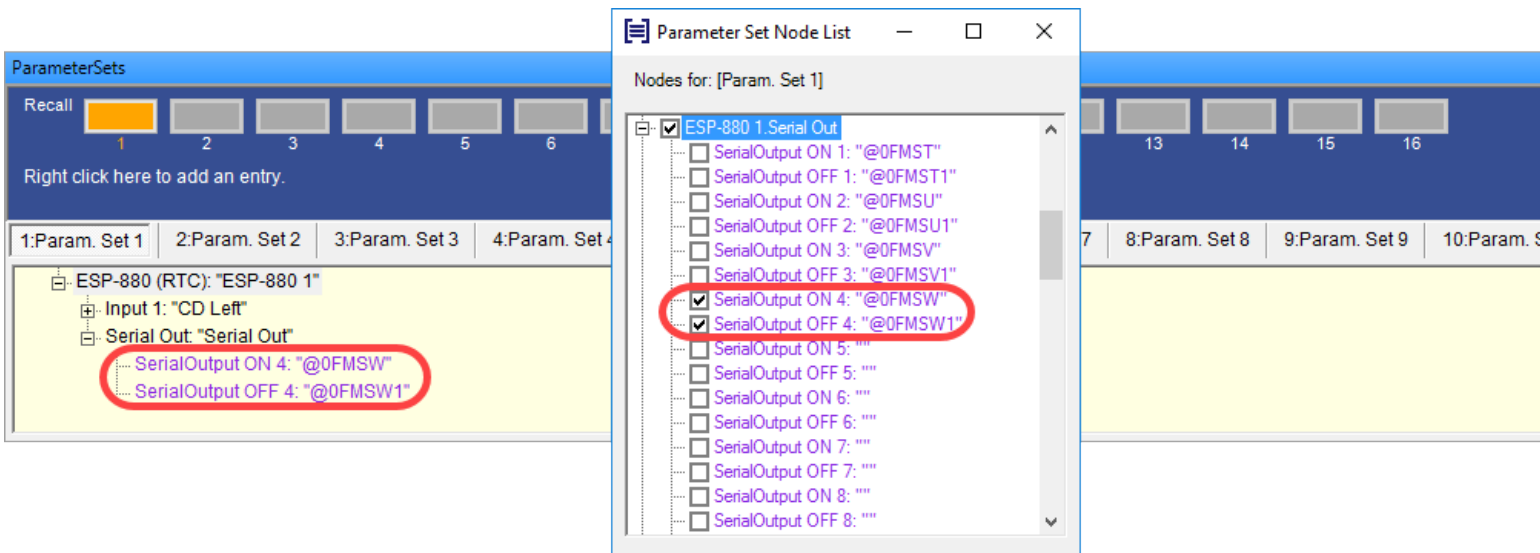

Parameter Set Node List serial output programming

NOTES:

- Unlike serial input strings, no control characters, such as carriage returns or line feeds, are assumed or automatically included when entering serial output strings.
- Serial output strings are not sent when offline.

Logic Programming (EX-1280C only)

About Logic

ControlSpace[®] Designer™ provides programmable logic functionality on EX-1280C sound processors. Logic blocks are placed and wired in a similar manner as SP blocks for audio. You can add simple boolean logic to the control flow in your design, or more complex logic using your own customized logic designs. Each

logic block is simple, but when multiple blocks are added together the designer can implement very complex operations.

NOTE: ESP sound processors do not support logic functionality.

Types of Logic Blocks

There are two types of logic blocks:

- Predefined logic blocks
- Logic blocks

Predefined logic blocks are pre-built logic blocks with a fixed number of input and output ports, e.g. 4-channel LATCH ALL. You cannot edit them.

Logic (custom) blocks allow you to create your own custom logic blocks from scratch, using a set of logic operators such as AND, OR, NOT, as well as FLIPFLOP and DEBOUNCE timing and memory functions. Unlike predefined logic, you can also set the number of input and output ports.

Additionally, many existing SP blocks, such as Gain, Ducker, and AMM, have built-in logic I/O support.

Logic Symbols

To display the logic input/output ports for a block, right-click the block and select **Show I/O Logic**. For all types of logic blocks and SP blocks that support logic I/O, the logic inputs appear on the top of the block and the outputs on the bottom of the block.

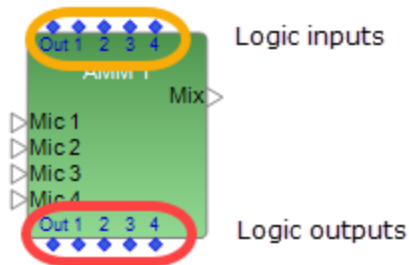

A blue-colored logic input or output represents a **Low** state. A gold-colored logic input or output represents a **High** state. This color coding is helpful when simulating logic offline to test various logic states and trace logic signal routing between blocks.

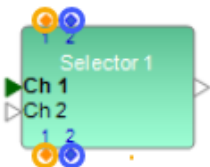

○ = True/On/High

○ = False/Off/Low

For more information on using logic, see:

[Adding Pre-Defined Logic Blocks](#)

[Adding Custom Logic Blocks](#)

[Showing or Hiding Logic Connections](#)

[Simulating Logic Offline](#)

[Logic Operators/Functions and Predefined Logic Blocks](#)

Logic Routes

For more information on logic support for block types, see:

[Logic and Testing Support for SP Blocks](#)

[General Purpose I/O Block Logic Support](#)

[Serial I/O Block Logic Support](#)

[Logic Input Block](#)

[Logic Output Block](#)

[Dante Endpoint and Microphone GP I/O Logic Support](#)

[Parameter Set Recall Block Logic Support](#)

Adding Pre-Defined Logic Blocks

ControlSpace Designer provides a number of predefined logic blocks that you can add to your design including, but not limited to, Latch All, LED Split, and Toggle/FF blocks in various fixed input and output port sizes. The basic functions of these blocks are described in [Logic Operators/Functions and Predefined Logic Blocks](#).

IMPORTANT: All predefined logic blocks have a preset number of input/output ports and the number of input and output ports may not be changed.

To add a predefined logic block to a design:

1. From the **Logic/Control > Pre-Defined Blocks** section of the SP Tool Kit, drag the desired predefined logic block into Signal Processing View.

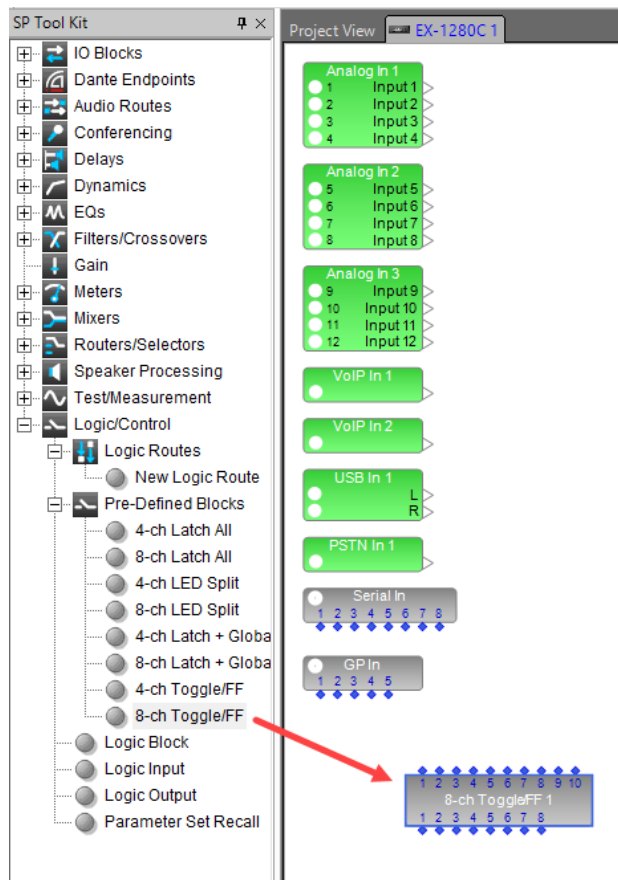

2. Wire the pre-defined logic block to any other SP blocks as needed.

NOTE: To view the block's logic wiring, double click the block.

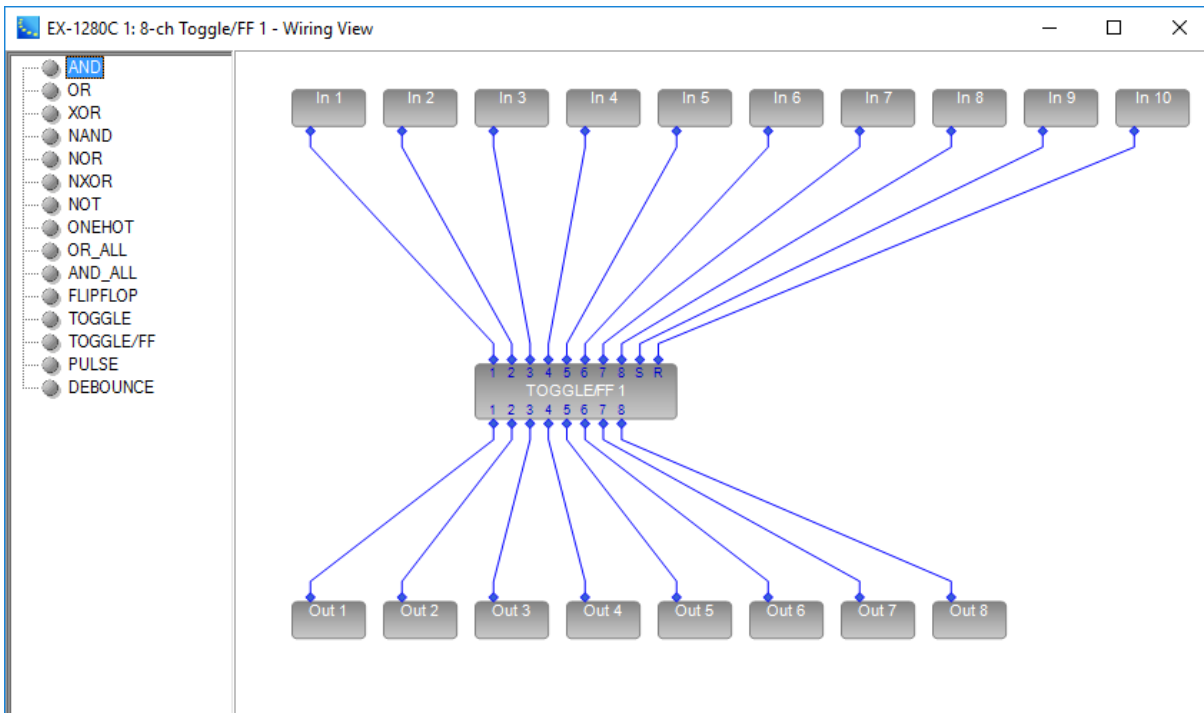

Adding Custom Logic Blocks

In addition to adding pre-defined logic blocks to a design, you can build and add your own custom logic blocks by dragging items from a palette of simple logic operators and more complex timing and memory functions. You can also select the number of input and output ports for the custom logic block. For definitions of logic operators and other functions that you can use to build custom logic, see [Logic Operators/Functions and Predefined Logic Blocks](#).

To create a custom logic block for a design:

1. From the **Logic/Control** section of the SP Tool Kit, drag a **Logic Block** block into Signal Processing View.

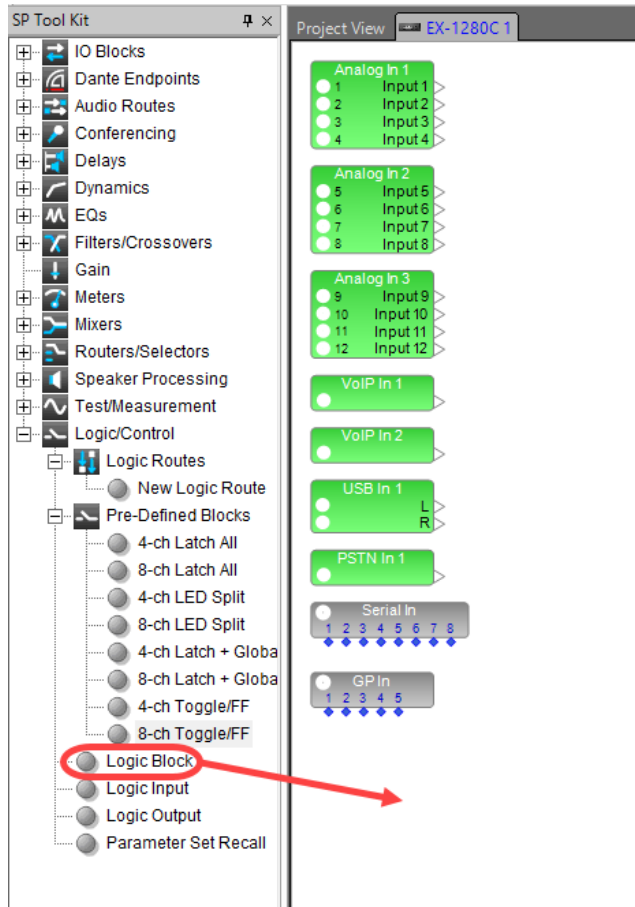

- In the Logic dialog, select or type in the number of ports (16 max for input and output) using the Inputs and Outputs port selector controls and click **OK**.

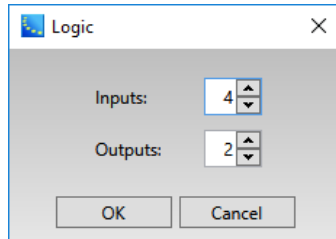

- The block is now added to Signal Processing View. To rename the block, you can edit the Label property in the block's Properties window, use the right-click menu to select **Rename**, or press the F2 key. You can change the number of input or output ports at any time by right-clicking the block and selecting **Change I/O Count**.

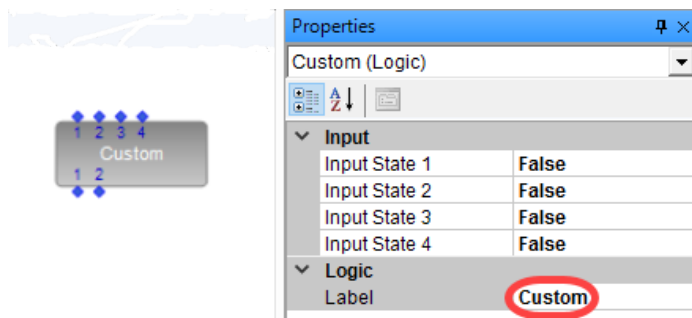

- To edit the block, double-click it to display the Wiring View.

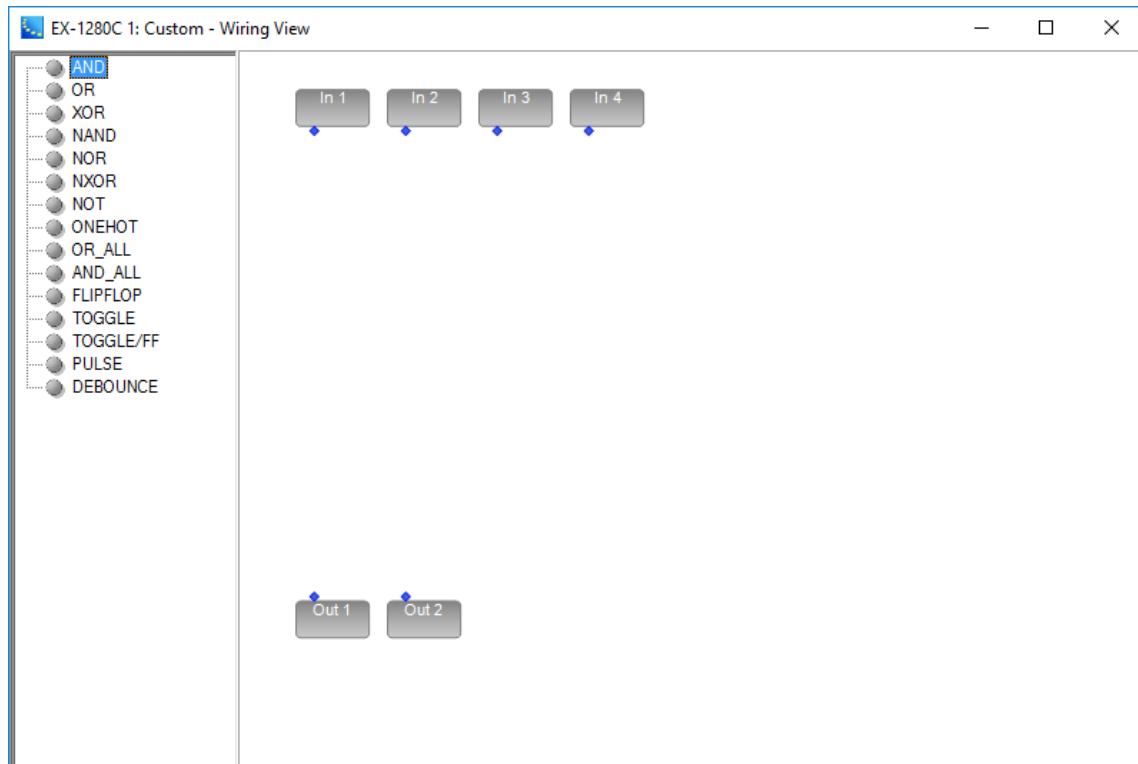

- From the left-hand panel, you can drag logic operators as well as memory and timing blocks into the wiring view. You will be prompted to enter the number of inputs for any logic element or block that you add.

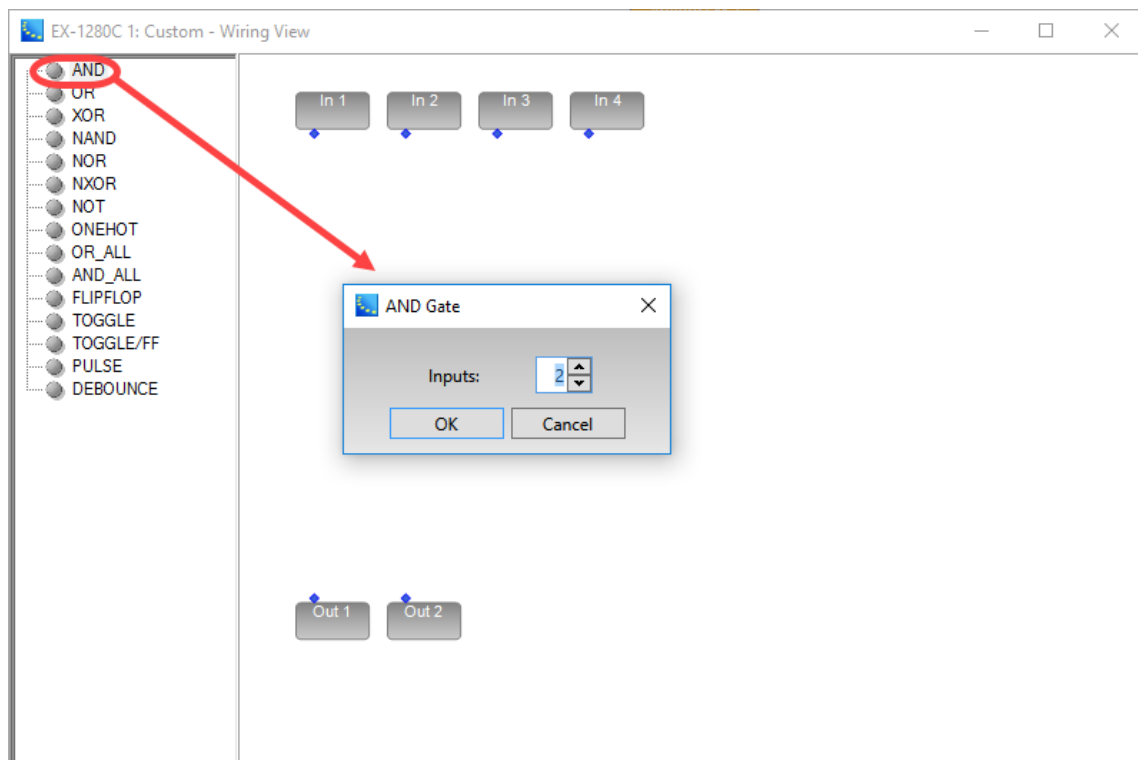

- Make the connections between elements as needed. As with SP blocks, you can modify wiring properties by right-clicking on a wire and editing the Wire Properties. You can also rename any logic element via the Label property in the element's Properties window, by using the right-click menu to select **Rename**, or by pressing the F2 key.

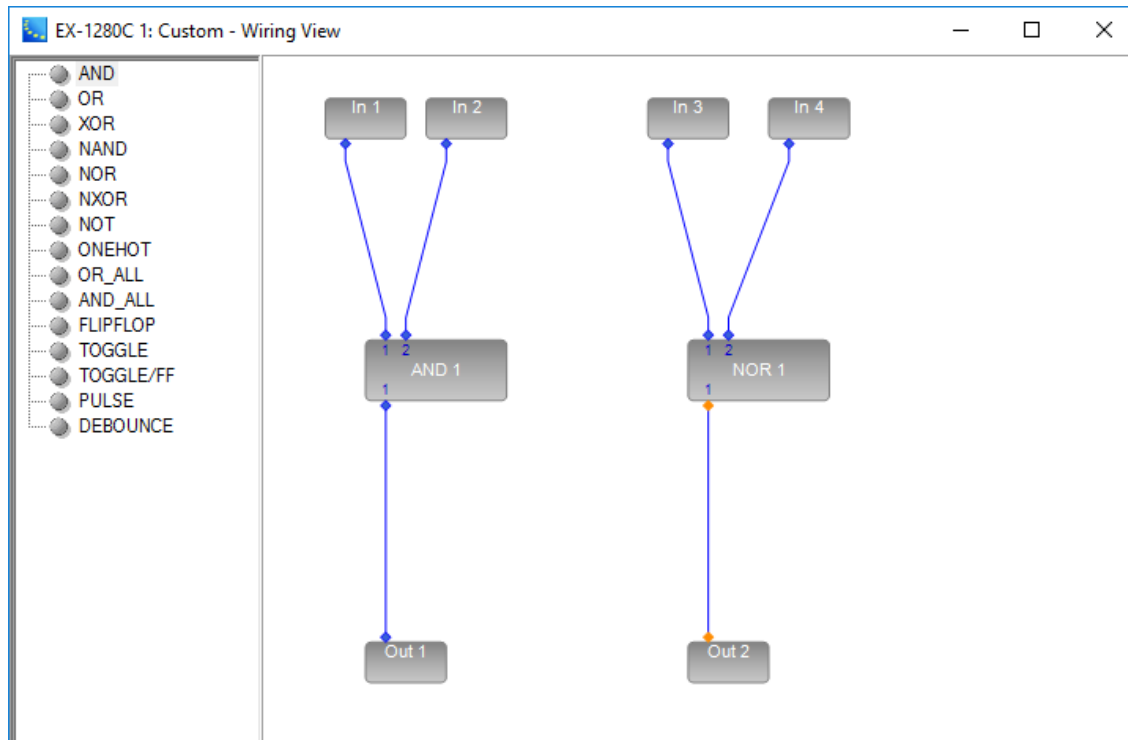

7. Once the custom logic block is created, you can wire it to any other SP blocks as needed.

Showing or Hiding Logic Connections

Because system design wiring can become quite complex, you have the option to either show or hide logic wiring in the design. This can be done for a single logic/SP block or globally throughout the design.

For a Block

To hide all logic ports and connections on any logic block or SP block that supports logic, right-click the block and select **Hide I/O Logic**.

To show all logic ports and connections on any logic block or SP block that supports logic, right-click the block and select **Show I/O Logic**.

In the example, the logic I/O for the Custom logic block is shown on the left and hidden on the right.

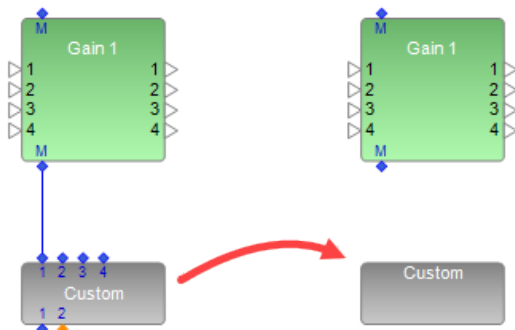

Show/Hide Logic I/O for a block

For a Design

To hide all logic ports and connections on all blocks in a design, from the Main menu select **View > Hide All Logic I/O**.

To show all logic ports and connections on all blocks in a design, from the Main menu select **View > Show Logic I/O** and then select **View > Show Signal Processing Logic I/O**.

In the example, the logic I/O for the entire design is shown on the left and hidden on the right.

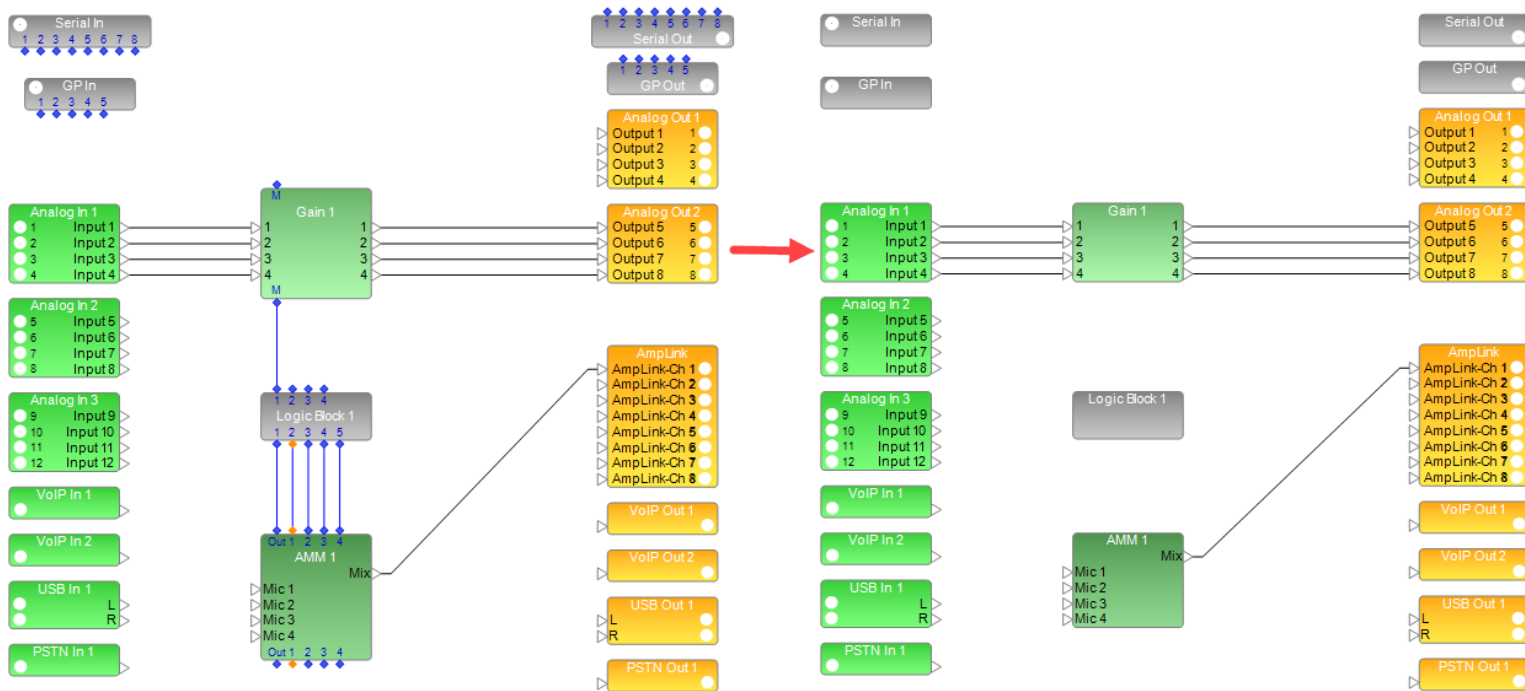

Show/Hide Logic I/O for a design

NOTE: View > Show Logic I/O shows or hides logic ports only. View > Show Signal Processing Logic I/O shows or hides logic I/O connections and ports on *signal processing blocks* only (does not affect ports on logic blocks).

Simulating Logic Offline

You can simulate all system logic in Signal Processing View offline.

For example (not shown), pressing a microphone's **Mute** button in the AMM control panel will put the logic output corresponding to that channel in a **High** state (the logic output symbol will turn gold). If the AMM block is wired to another block that supports logic, this will activate the logic input in that block and propagate to that block's logic output, triggering another logic event in the chain, and so on.

In another example (see below), a switch closure is used to apply a **High** to logic output #1 of a GPI block. This, in turn, sets logic input port "Out" on AMM 1 to **High** which mutes the master audio output of AMM 1. The **High** logic signal propagates to logic output port "Out" of AMM 1 and the logic input port "Out" of AMM 2, causing that AMM to also mute its master audio output.

This entire logic path can be simulated by using the GPI control panel's test function. The gold-colored logic ports represent the **High** states of the logic inputs and outputs at each stage along the path.

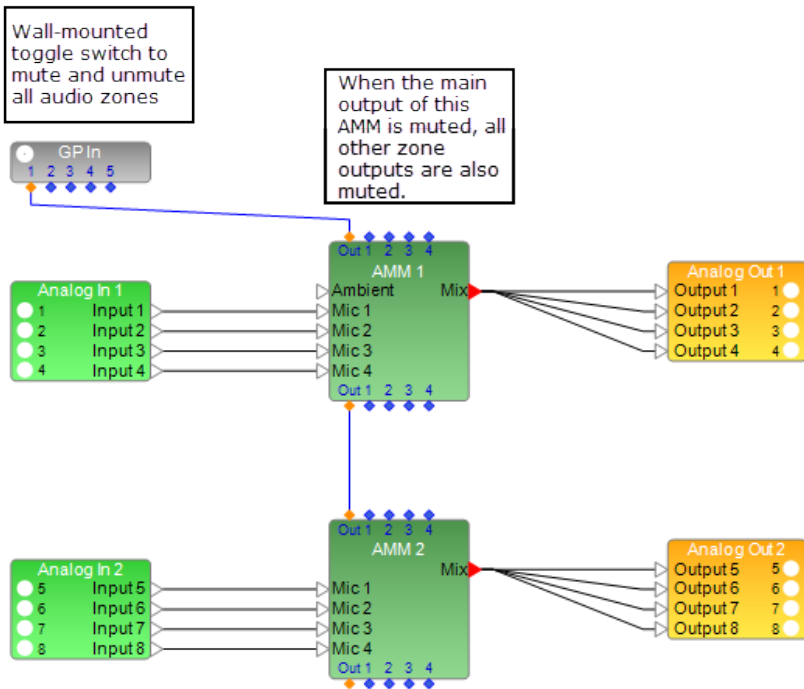

Example of logic simulation to mute multiple zones

Logic Operators/Functions and Predefined Logic Blocks

This topic describes the behavior of logic operators and functions that you can use to create custom logic blocks or which form the basis of operation for many predefined logic blocks. Certain functions described here - specifically Latch All, Latch + Global, LED Split - are only available as predefined logic blocks. Toggle/FF is available both as a logic operator you can use to create custom logic blocks and as a predefined logic block.

When dragging logic operators or functions into Wiring View to create custom logic, you will be prompted to specify the number of inputs for the logic element. See [Adding Custom Logic Blocks](#).

AND Operator

Example of Symbol	Input Ports	Output = High when...	Output = Low when...
	2-16	All inputs are High	All inputs are Low

OR Operator

Example of Symbol	Input Ports	Output = High when...	Output = Low when...
	2-16	Any or all logic inputs are High	All logic inputs are Low

XOR Operator

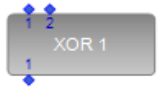
Example of Symbol	Input Ports	Output = High when...	Output = Low when...
	2-16	An odd number of logic inputs is High	An even number of logic inputs is High

NAND Operator

Example of Symbol	Input Ports	Output = High when...	Output = Low when...
	2-16	Any or all logic inputs are Low	All logic inputs are High

NOR Operator

Example of Symbol	Input Ports	Output = High when...	Output = Low when...
	2-16	All logic inputs are Low	Any or all logic inputs are High

NXOR Operator

Example of Symbol	Input Ports	Output = High when...	Output = Low when...
	2-16	An even number of logic inputs is High	An odd number of logic inputs is High

NOT Operator



The NOT operator supports from 1-16 I/O ports. An output of the NOT operator is **High** when its corresponding logic input is **Low**. An output of the NOT operator is **Low** when its corresponding logic input is **High**.

ONEHOT Operator

Example of Symbol	Input Ports	Output = High when...	Output = Low when...
	2-16	Any one (but <i>only</i> one) logic input is High	More than one logic input is High OR All logic inputs are Low

OR_ALL Operator

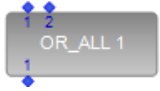

OR_ALL operators have an equal number of logic inputs and outputs, plus one ALL logic input which is the last numbered logic input port. For example, the ALL logic input on a two-input port OR_ALL block would be port 3.

An output of the OR_ALL operator is **High** when its corresponding logic input is **High** OR when the ALL logic input is **High**.

An output of the OR_ALL operator is **Low** when its corresponding logic input is **Low** AND the ALL logic input is **Low**.

AND_ALL Operator

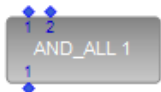

AND_ALL operators have an equal number of logic inputs and outputs, plus one ALL logic input which is the last numbered logic input port. For example, the ALL logic input on a two-input port AND_ALL block would be port 3.

An output of the AND_ALL operator is **High** when its corresponding logic input is **High** AND when the ALL logic input is **High**.

An output of the AND_ALL operator is **Low** when its corresponding logic input is **Low** OR when the ALL logic input is **Low**.

FLIPFLOP Operator



FLIPFLOP operators have two logic inputs per output, ranging from 2 inputs x 1 output to 16 inputs x 8 outputs.

The logic inputs work in trigger/reset pairs. Each logic input number has an S or R suffix, indicating whether it has a set (trigger) or reset function. The S logic input is the trigger for the correspondingly numbered logic output. The R logic input is the reset for the trigger/reset pair.

Example: Logic input 1S and 1R are a trigger/reset pair. Logic input 1S is the trigger for logic output 1. Logic input 1R is the trigger reset for the pair.

NOTE: The term "pulsed" used in this section is defined as a momentary transition from Low to High and back to Low.

An output of a FLIPFLOP operator is set to **High** when its corresponding logic input trigger is initially pulsed or latched **High**. If there is no trigger reset, that input trigger can change states of the logic input infinitely without affecting the logic output state.

The same output of the FLIPFLOP operator is set to **Low** when the corresponding trigger reset is pulsed or latched **Low** and the logic input trigger reverses (or flip-flops) its previous state. For example, after trigger reset, the logic trigger previously set the logic input state to **High** and now it flip-flops that state to **Low**.

TOGGLE Operator



TOGGLE operators have an equal number of logic inputs and outputs, ranging from 1 to 16. Each logic input affects its corresponding logic output.

NOTE: The term "pulsed" used in this section is defined as a momentary transition from Low to High and back to Low.

Assuming the previous state of a logic output in the TOGGLE operator was **Low**, the output of a TOGGLE operator is set to **High** when the corresponding logic input is pulsed. If the logic input is pulsed again, the logic output is set to **Low**. In this instance, if a logic input is latched **High** to set the logic output to **High**, that logic input must be set to **Low** and set back to **High** to toggle the corresponding logic output.

Assuming the previous state of a logic output in the TOGGLE operator was **High**, the output of a TOGGLE operator is set to **Low** when the corresponding logic input is pulsed. If the logic input is pulsed again, the logic output is set to **High**. In this instance, if a logic input is latched **Low** to set the logic output to **Low**, that logic input must be set to **High** and set back to **Low** to toggle the corresponding logic output.

TOGGLE/FF Operator



TOGGLE/FF (TOGGLE/FLIPFLOP) operators have one discrete logic input per logic output (ranging from 1-16), in addition to a single global S logic input and a single global R logic input.

NOTE: The term "pulsed" used in this section is defined as a momentary transition from Low to High and back to Low.

If a given logic input is pulsed (or set **High** and reset to **Low**), the corresponding logic output will toggle states.

For example, if logic output #1 on a Toggle/FF block is currently set **Low**, pulsing logic input #1 will set logic output #1 to **High**. And if logic output #1 on a Toggle/FF block is currently set **High**, pulsing logic input #1 will set logic output #1 to **Low**.

Global Logic Inputs - S and R

If the global S logic input is pulsed, all logic outputs are set to **High**. If the global R logic input is pulsed, all logic outputs are set to **Low**.

PULSE Operator



PULSE operators have an equal number of logic inputs and outputs. Each logic input affects its corresponding logic output. There are three Pulse modes:

- Standard
- Single pulse
- Force on

You can select these modes by double clicking the PULSE operator block in Wiring View to access the control panel.

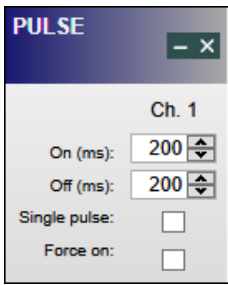

In the mode descriptions that follow, the rate at which the logic output is toggled On/Off is determined by the On and Off timer settings in the control panel.

The On timer sets/determines how long a particular logic output's state remains set **High** before toggling its output state back to **Low**. This timer can be set from 0 ms (no delay) to 6000 ms (6 seconds).

The Off timer sets/determines how a particular logic output's state remains **Low** before toggling back to **High**. This timer can be set from 0 ms (no delay) to 6000 ms (6 seconds).

NOTE: The term "pulsed" used in this section is defined as a momentary transition from Low to High and back to Low.

Standard Mode

In Standard Mode, neither the Single Pulse nor Forced On option is selected. When a logic input on this block is latched **High**, its corresponding logic output is toggled On, then Off continuously until the logic input is set to **Low**.

If a logic input on this block is pulsed, its corresponding logic output will toggle On, then Off *once* for the duration set in the block's On/Off timers.

Single Pulse Mode

When the Single Pulse option is selected and a logic input is latched **High** (or pulsed On, then Off), its corresponding logic output will toggle On, then Off *once and only once*.

If a logic input was latched **High** to trigger the logic output pulse, that logic input must be set **Low** and then set back to **High** to trigger another logic output pulse.

Force On Mode

When the Force On option is selected, all logic inputs are set to **High** and all logic outputs are toggled On, and then Off continuously until Forced On mode is disabled.

DEBOUNCE Operator



The DEBOUNCE operator has a set of On and Off times that the user can adjust to control when logic inputs and outputs are set **High** and **Low**. To access these time settings, double click the DEBOUNCE operator block.

The On timer setting determines how long after a particular logic input is set **High** that the corresponding logic output is set **High**. The timer range is from 0 (no delay) to 6000 milliseconds. The Off timer setting determines how long after a particular logic input is set **Low** that the corresponding logic output is set **Low**. The timer range is the same as for the On timer.

An output of a DEBOUNCE operator is set to **High** (after the set timing delay) when a corresponding logic input is set to **High**.

An output of a DEBOUNCE operator is set to **Low** (after the set timing delay) when a corresponding logic input is set to **Low**.

LATCH ALL Predefined Block



LATCH ALL blocks are effectively OR blocks with a TOGGLE function tied to all of its logic outputs. LATCH ALL is only available as a pre-defined logic block in four and eight-channel versions. These blocks have an equal number of logic inputs and outputs.

NOTE: The term "pulsing" or "pulsed" used in this section is defined as a momentary transition from Low to High and back to Low.

If any of the connected logic inputs are pulsed (or set **High** and reset to **Low**), all of the logic outputs will toggle states. For example, if all of the logic outputs on a LATCH ALL block are currently set **Low**, pulsing any of the logic inputs will set the logic output state of all logic outputs to **High**.

If all of the logic outputs on a LATCH ALL block are currently set **High**, pulsing any of the logic inputs will set the logic output state of all logic outputs to **Low**.

LATCH + GLOBAL Predefined Block



LATCH + GLOBAL blocks are effectively TOGGLE blocks with a OR function tied to each of its logic outputs. LATCH + GLOBAL is only available as a pre-defined logic block in four and eight-channel versions. These blocks have an equal number of discrete logic inputs and logic outputs with one additional Global logic input (logic input port #5 for four-channel blocks and port #9 for eight-channel blocks).

NOTE: The term "pulsed" used in this section is defined as a momentary transition from Low to High and back to Low.

If a given logic input is pulsed (or set **High** and reset to **Low**), the corresponding logic output will toggle states.

Example: If logic output #1 on a LATCH + GLOBAL block is currently set **Low**, pulsing logic input #1 will set logic output #1 to **High**. And if logic output #1 on a LATCH + GLOBAL block is currently set **High**, pulsing logic input #1 will set logic output #1 to **Low**.

Global Logic Input

When the Global logic input is pulsed (or set **High** and reset to **Low**), it will toggle any and all logic outputs that are not currently set **High**. Therefore, if all logic outputs on a LATCH + GLOBAL block are set **Low**, pulsing the Global logic input will set all logic outputs **High**. If the Global logic input is pulsed again, all logic outputs will be set **Low**.

If any of the LATCH + GLOBAL block's logic outputs were set **High** from their discrete logic input(s), pulsing the Global logic input will only toggle the logic outputs currently set **Low**.

Logic outputs must be set **Low** by their corresponding logic inputs if they are to be part of the Global logic toggle.

LED SPLIT Predefined Block



The LED SPLIT block is only available as a pre-defined logic block in four and eight-channel versions. The LED SPLIT block has two corresponding logic outputs per logic input. So, a four-channel LED SPLIT block has four logic inputs and eight logic outputs; an eight-channel LED SPLIT block has eight logic inputs and 16 logic outputs:

- Logic Input #1 corresponds to logic outputs 1 & 2.
- Logic Input #2 corresponds to logic outputs 3 & 4.
- Logic Input #3 corresponds to logic outputs 5 & 6.
- Logic Input #4 corresponds to logic outputs 7 & 8

...and so on.

When a logic input on an LED SPLIT block is set **High**, its corresponding odd-numbered logic output is also set **High** while its corresponding even-numbered logic output is set **Low**.

Example:

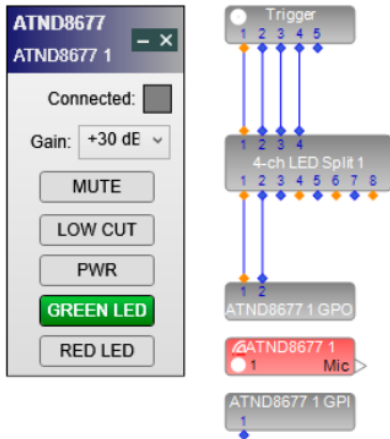
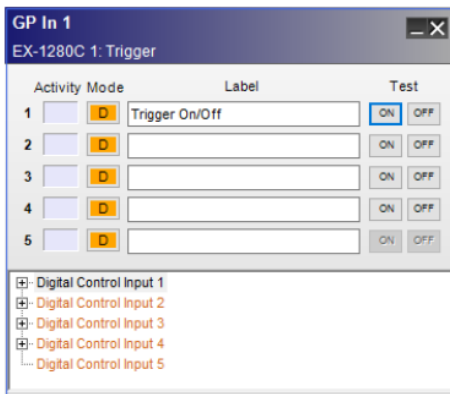

When a logic input on an LED SPLIT block is set **Low**, its corresponding odd-numbered logic output is also set **Low** while its corresponding even-numbered logic output is set **High**.

Example:

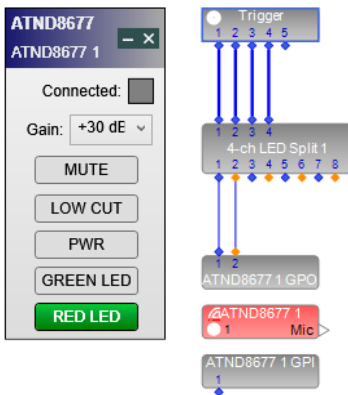
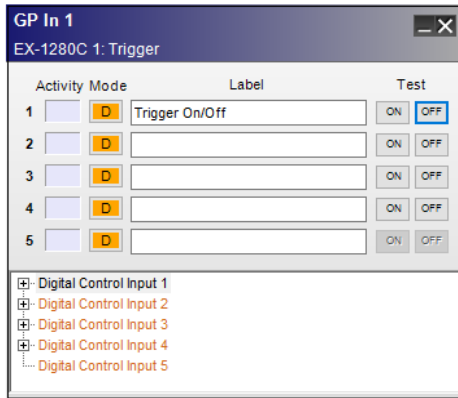

For example, when connected to a Dante-equipped microphone's GPO port, the LED SPLIT block is a useful tool to toggle the Dante-equipped microphone's Green and Red LED indicators to indicate the microphone's mute status.

TOGGLE/FF Predefined Block



Toggle/FF is only available as a pre-defined logic block in four and eight-channel versions. These blocks have one discrete logic input per logic output, in addition to a single global S logic input and a single global R logic input. In the four-channel version, global S is logic input port 5 and global R is logic input port 6; in the eight channel version, it is logic input port 9 and 10, respectively.

NOTE: The term "pulsed" used in this section is defined as a momentary transition from Low to High and back to Low.

If a given logic input is pulsed (or set **High** and reset to **Low**), the corresponding logic output will toggle states.

Example: If logic output #1 on a Toggle/FF block is currently set **Low**, pulsing logic input #1 will set logic output #1 to **High**. And if logic output #1 on a Toggle/FF block is currently set **High**, pulsing logic input #1 will set logic output #1 to **Low**.

Global Logic Inputs - S and R

If the global S logic input is pulsed, all logic outputs are set to **High**. If the global R logic input is pulsed, all logic outputs are set to **Low**.

Logic Routes

Use logic routes in ControlSpace® Designer™ to route logic signals between two locations within a single ESP or EX-1280C device as if they were connected, but without the need to wire them together directly. It is similar to a named object or net in schematic diagrams, where objects with the same name are assumed to be connected.

This provides a convenient virtual wiring shortcut from one location in a design to another and is helpful when many intervening or blocking design elements make it difficult to route logic signals between the two points.

To create a logic route:

1. Drag the block named "New Logic Route" from the SP Tool Kit into Signal Processing View. This creates a single-input logic block in Signal Processing View and a matching single-output logic block in the SP Tool Kit, both labeled Logic Route x by default, as shown below.

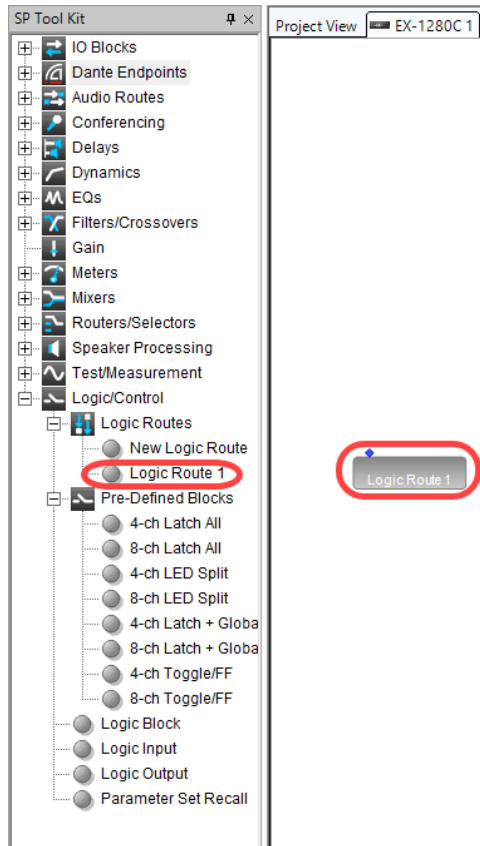

2. Drag the matching single-output logic route block from the SP Tool Kit into Signal Processing View. You will re-position the blocks later.

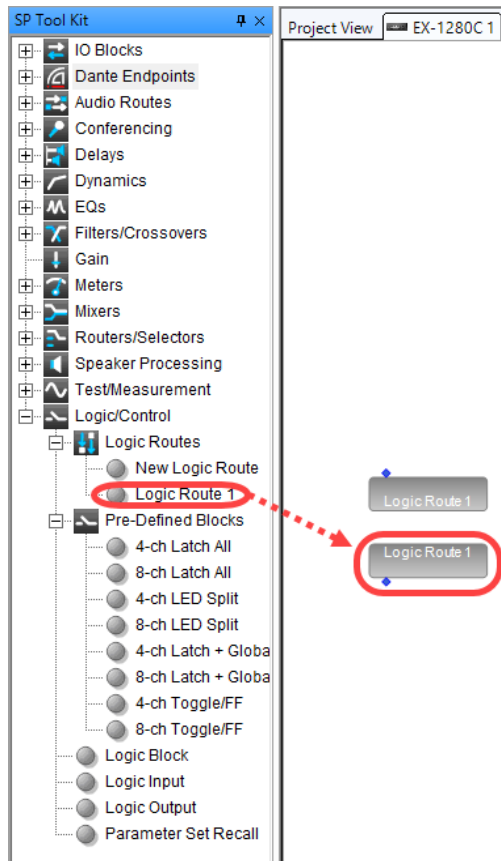

3. If needed, change the block labels by selecting either block and changing the Label name in the Properties window (**Window > Properties**), by using the right-click menu on the block to select **Rename**, or by pressing the F2 key. The labels automatically change on both blocks, since the labels must match to implement the logic route.

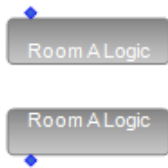

4. If needed, change the number of ports by right clicking on the single-input block and selecting **Change Channel Count**. As with label changes, any change in the number of ports will propagate to both blocks.

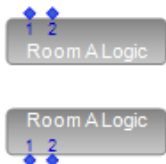

5. Move the input and output logic route blocks to the appropriate locations in your design.
6. Wire any logic inputs to the input logic route block and any logic outputs from the output logic route block, as needed.

Logic signals will now flow from the input logic route block to the output logic route block as if they were interconnected.

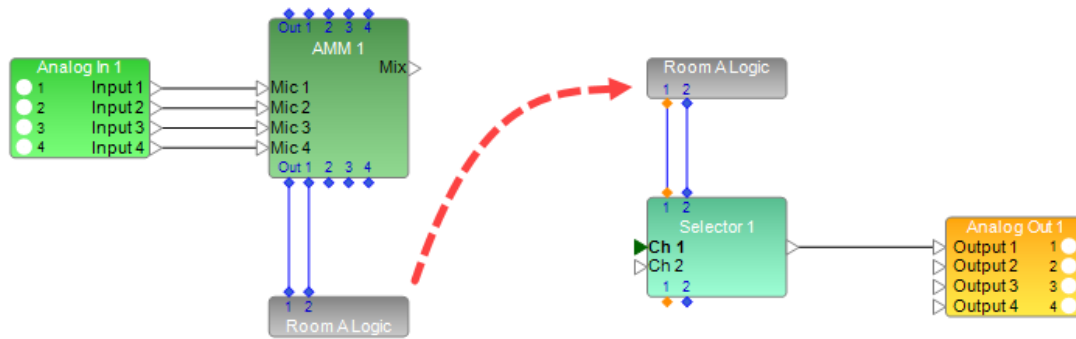

Logic and Testing Support for SP Blocks

This topic describes logic I/O behavior and testing features for the following SP blocks that support logic I/O:

- Ducker
- Gate
- Gain
- Meters
- AMM - Gain Sharing and AMM - Gated
- Source Selector (mono or stereo)
- Conference Room Router

NOTES:

- To display the logic input/output ports for a block, right-click the block and select Show I/O Logic.
- The ESP sound processors do not support logic functionality.

Default Logic Operation

The table describes the default logic behavior for supported SP blocks - that is, when the **Invert** or **Invert Logic Output** option is *not* selected in the block’s control panel.



Default Logic Behavior for SP Blocks

SP Block Type	Notes	Logic Inputs	Default Logic Outputs
<p>Ducker</p>	<p>Ducker’s logic input allows an external logic input source to activate or de-activate the ducking feature of the block.</p> <p>The logic input is OR’ed with the audio sidechain input of the block, so that either the sidechain input or the external logic source can activate or de-activate the ducking func-</p>	<p>When logic input O is High...</p>	<p>...logic output A is also High. The Ducker block is active and ducks the audio output of the block.</p> <p>If an external logic input source connected to the block is latched in a High state, the Ducker block’s audio output remains ducked until the logic input O source state is Low.</p>

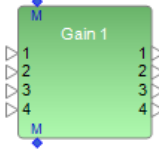
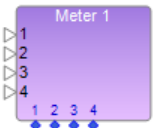
Default Logic Behavior for SP Blocks

SP Block Type	Notes	Logic Inputs	Default Logic Outputs
	tion.		
		When logic input O is Lowlogic output A is also Low . The Ducker block is inactive.
Gate 		No logic inputs	Logic output A is High - when audio signal passing into block reaches threshold level set in block and opens the "gate", indicating that the audio channel is active. Logic output A is Low - when audio signal passing into block falls or remains below threshold level set within the block that opens the "gate", indicating the audio channel is inactive.
Gain 	Gain's logic input allows an external logic input source to mute or unmute the audio output of the block.	When logic input M is High ... When logic input M is Lowlogic output M is also High and audio output of block is muted. ...logic output M is also Low and audio output of block is unmuted.
Meters 		No logic inputs	High - when audio signal passing into block reaches threshold level set in block, within the tolerance set in the Tol. field in dBFS. Low - when audio signal passing into block falls below threshold level set in block, within the tolerance set in the Tol. field in dBFS.
AMM Gain Sharing and AMM Gated	AMM's logic inputs allow external logic	When the logic input port "Out"	...all of the logic outputs are also High and the main audio output of

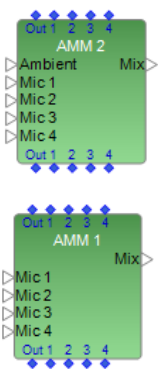
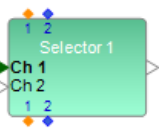

Default Logic Behavior for SP Blocks

SP Block Type	Notes	Logic Inputs	Default Logic Outputs
	<p>input sources to mute or unmute the main audio output of the block as well as individual AMM mic input channels.</p> <p>Logic input port "Out" on an AMM affects only the main audio output of the AMM. The remaining numbered logic I/O ports on the AMM affect the corresponding individual AMM mic input channels.</p>	<p>is High...</p> <p>When the logic input port "Out" is Low...</p> <p>When any numbered logic input is High...</p> <p>When any numbered logic input is Low...</p>	<p>the block is muted.</p> <p>...all of the logic outputs are also Low and the main audio output of the block is unmuted.</p> <p>...the corresponding numbered logic output is also High and the corresponding AMM mic input channel is muted.</p> <p>...the corresponding numbered logic output is also Low and the corresponding AMM mic input channel is unmuted.</p>
<p>Source Selector (mono or stereo)</p> 	<p>Source Selector's logic inputs allow external logic input sources to determine which audio input is routed to the output of the block.</p> <p>Only one logic input can be High at any given time.</p>	<p>When a logic input is High (via Pulse or XOR latch)...</p>	<p>...the corresponding numbered logic output is also High and the corresponding audio input signal is routed to the output of the Source Selector block.</p> <p>All other logic outputs will be Low.</p>
<p>Conference Room Router</p> 	<p>CRR's logic inputs allow external logic input sources to mute and unmute each of the three controls in the Master Controls Panel as well as the controls in the Input Sources Panel.</p>	<p>When a logic input is High...</p> <p>When a logic input is Low...</p>	<p>...the corresponding logic output is also High and the corresponding CRR control is muted (see note).</p> <p>Note: CRR logic input/output ports N, M, and V correspond to the Non-Mic Mix, Mic Mix, and Master Volume controls in the CRR control panel, respectively. Logic input/output ports labeled P and numbered ports map to Program and Far End controls, respectively.</p> <p>...the corresponding logic output is also Low and the corresponding CRR control is unmuted (see note in previous table entry).</p>

Inverted Logic Operation

The table describes inverted logic behavior for SP blocks that support it. To enable inverted logic, select the **Invert** or **Invert Logic Output** option in the block's control panel.

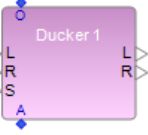
Inverted Logic Behavior for SP Blocks

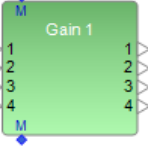
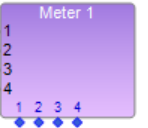
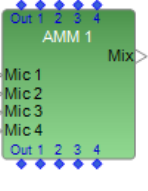
SP Block Type	When Invert Logic is selected...
<p>Ducker</p> 	<p>...the logic output A is High only when the block is <i>not</i> actively applying its processing to the audio signal (logic input O is Low). When the Ducker is active (logic input O is High), the logic output A is Low.</p>
<p>Gate</p> 	<p>...and the system is active/online, a Gate's logic output A will be set High <i>until</i> the audio input level threshold set within the Gate is reached or exceeded. At that point the Gate is "open", allowing that audio signal to pass and the logic output A is set Low.</p>
<p>Gain</p> 	<p>...a High input M results in a Low output M and the main audio is unmuted. A Low input M results in a High output M and the main audio is muted.</p>
<p>Meters</p> 	<p>...and the system is active/online, a Meter's logic output will be set High <i>until</i> the audio input level threshold set within the Meter's block is reached or exceeded (within the tolerance set in the Tol. field in dBFS). At that point, a Meter's logic output is set Low.</p>
<p>AMM Gain Sharing</p> 	<p>...and when logic input port "Out" is High, all of the logic outputs are Low and the main audio output of the block is unmuted.</p>
	<p>...and when logic input port "Out" is Low, all of the logic outputs are High and the main audio output of the block is muted.</p>
	<p>...and when any numbered logic input is High, the corresponding logic output is Low and the corresponding AMM mic input channel is unmuted.</p>
	<p>...and when any numbered logic input is Low, the corresponding logic output is High and the corresponding AMM mic input channel is muted.</p>
<p>Source Selector (mono or stereo)</p>	<p>... the corresponding logic output is set Low when a particular source is selected. All other logic outputs will be High.</p>

Inverted Logic Behavior for SP Blocks

SP Block Type	When Invert Logic is selected...
	

Logic Testing Support

The following SP blocks have logic output testing features available in their control panels:

- Ducker
- Gate
- Meters

The table summarizes these features.

Logic Output Testing Features for SP Blocks

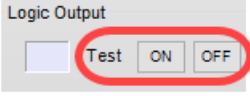
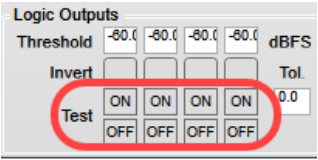
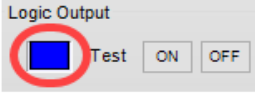
Feature	Description
<p>Test On and Off buttons Example 1- Ducker:</p>  <p>Example 2 - Meters:</p> 	<p>On - sets the logic output to High Off - sets the logic output to Low</p>
<p>Logic output indicator</p> 	<p>When lit, indicates that the SP block is actively applying its signal processing to the audio signal. When not illuminated, the SP block is not doing any signal processing. Note: The Meters control panel does not have a logic output indicator.</p>

General Purpose I/O Block Logic Support

This topic describes logic I/O behavior for General Purpose I/O blocks.

NOTE: To display the logic input/output ports for a block, right-click the block and select Show I/O Logic.

GP In Block Logic

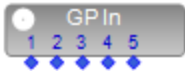

A logic output on the GP In block is **On** when an external device such as a switch or potentiometer connected to the corresponding physical GPI port on the EX-1280C closes.

A logic output on the GP In block is **Off** when an external device such as a switch or potentiometer connected to the corresponding physical GPI port on the EX-1280C opens.

GP Out Block Logic



When a logic input on the GP Out block is **On**, the corresponding physical GPO port on the EX-1280C is also **On**.

When a logic input on the GP Out block is **Off**, the corresponding physical GPO port on the EX-1280C is also **Off**.

Serial I/O Block Logic Support

This topic describes logic I/O behavior for serial I/O blocks.

NOTE: To display the logic input/output ports for a block, right-click the block and select Show I/O Logic.

Serial In Block Logic



The logic outputs on the Serial In block are **High** when the EX-1280C receives a remote serial string that matches one of the **On** strings set in the serial string list in the block.

The logic outputs on the Serial In block are **Low** when the EX-1280C receives a remote serial string that matches one of the **Off** strings set in the serial string list in the block.

NOTE: Serial In blocks can store up to 64 On and Off strings.

Serial Out Block Logic

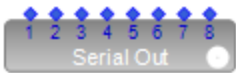

When a logic input on the Serial Out block is **High** the EX-1280C sends a pre-defined serial string that matches one of the **On** strings set in the serial string list in the block.

When a logic input on the Serial Out block is **Low** the EX-1280C sends a pre-defined serial string that matches one of the **Off** strings set in the serial string list in the block.

NOTE: Serial Out blocks can store up to 64 On and Off strings.

Logic Input Block

You can configure Logic Input blocks to trigger any number of events within a system. You can manually activate Logic Input blocks through the Logic Input block's control panel or you can use a third-party control system to trigger events.

The logic outputs on these blocks can be directly wired to any logic inputs within your design. When the Logic Input block's logic output(s) are set to On, Off or are Pulsed via the block's control panel, logic events within the connected device(s) are triggered.

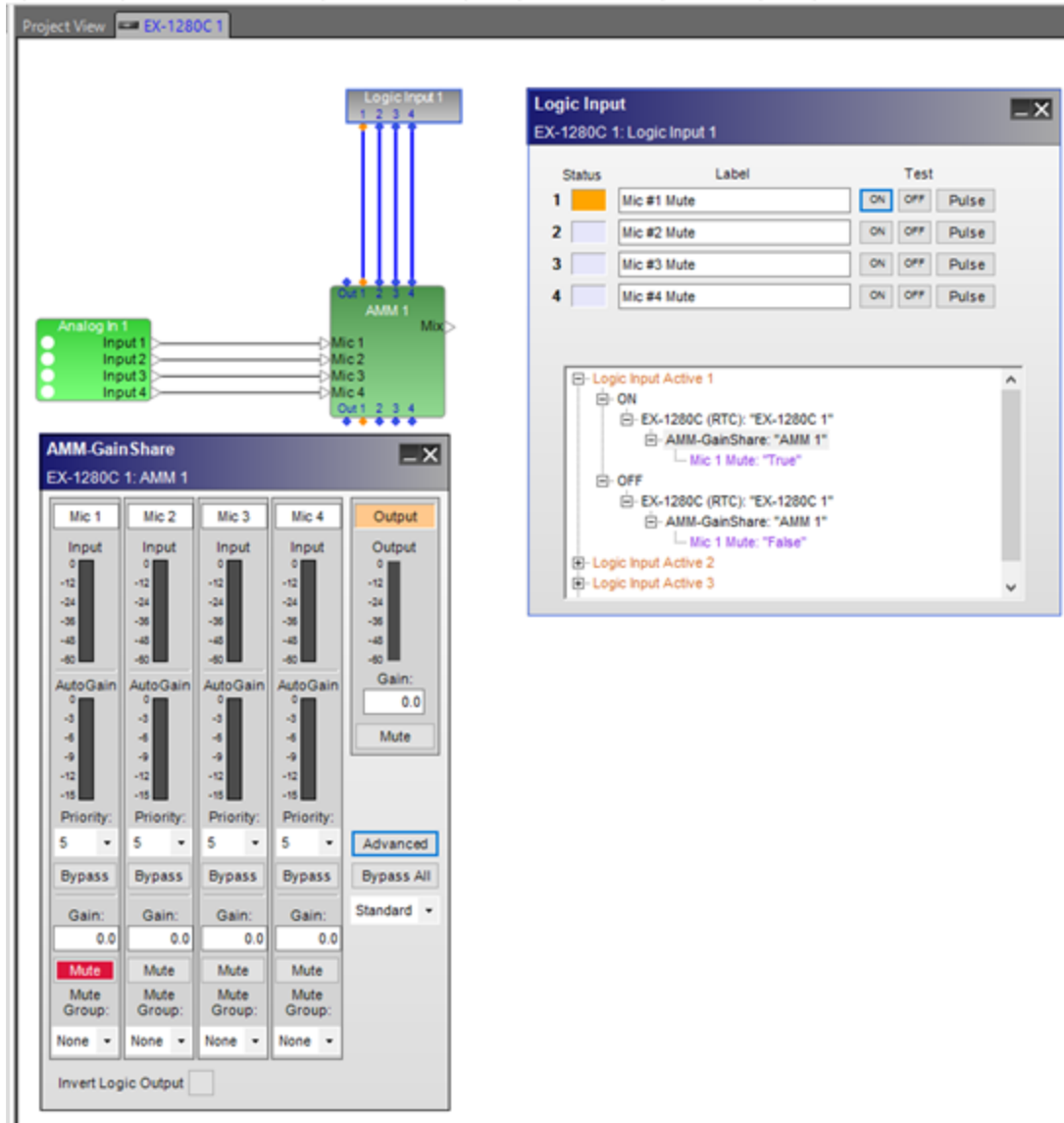

Logic Input block's output wired to Mic #1 input of AMM activates Mute on Mic #1 when in "On" state

The Logic Input block can also be configured to trigger events without wiring the block's outputs to other logic-enabled blocks.

NOTE: To display the logic input/output ports for a block, right-click the block and select Show I/O Logic.

Setting the Number of Outputs

To set the number of output ports for a Logic Input block:

1. Drag the Logic Input block from the Logic/Control category in the SP Tool Kit into Signal Processing View.
2. In the Logic Input dialog, select or type in the number of output ports (up to 16 maximum), using the Outputs ports selector control.

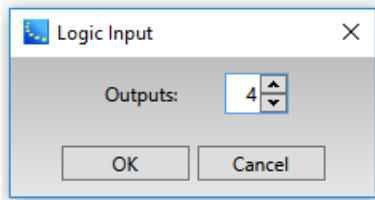

3. Click **OK** to add the block to the Signal Processing View.

You can add outputs to it at any time by right clicking on the block and selecting **Change output count**. You can then select the number of outputs to add, up to the maximum of 16.

Logic Input Block and Control Panel

Double-click on the Logic Input block in Signal Processing View to open its control panel.

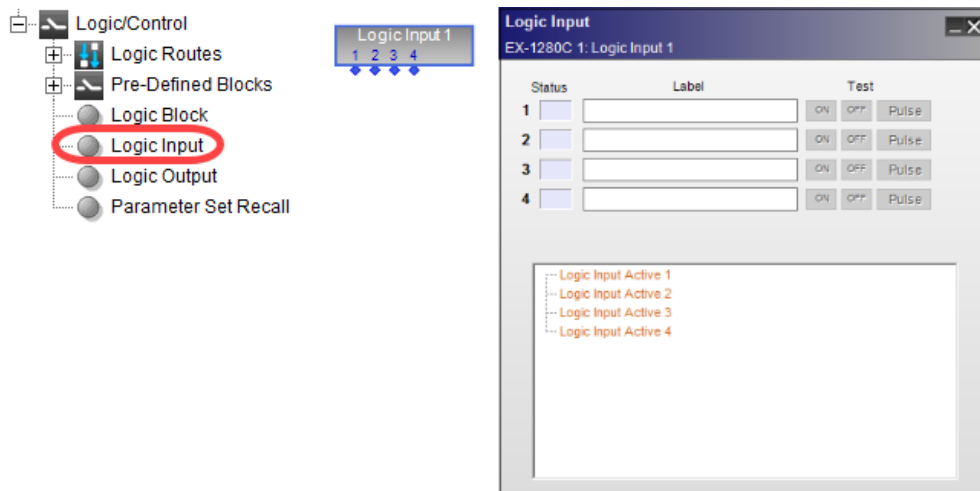

Logic Input block and control panel

Configuring a Logic Input Block

To configure a Logic Input block:

1. Drag a compatible device from Device View onto the Logic Input Active link in the block's control panel programming tree. Compatible devices include but are not limited to Gains, Mixers and Source Selectors.
2. Use the Logic Input block's control panel to set the Logic Outputs to On, Off or Pulse.
 - Setting the Logic Input block's output to On will trigger the pre-configured action for the ON state.
 - Setting the Logic Input block's output to Off will trigger the pre-configured action for the OFF state.
 - Setting the Logic Input block's output to Pulse will trigger the pre-configured action when the output is pulsed.

The screenshot displays the ControlSpace Designer interface for the EX-1280C 1 block. At the top, a block diagram shows the 'Logic Input 1' block with four outputs (1-4) connected to the 'Analog In 1' block, which has four inputs (Input 1-4). The 'Analog In 1' block is connected to the 'AMM 1' block. Below the diagram is the 'EX-1280C Input Control Panel [4 channels]' for 'EX-1280C 1'. This panel features four channels, each with a 'Pre-Gain' control (0 dB) and a 'dBFS' meter ranging from 0 to -60 dBFS. Each channel also has 'MUTE' and 'PWR' buttons. To the right is the 'Logic Input' panel for 'EX-1280C 1: Logic Input 1'. It shows a table of logic events for each input:

Status	Label	Test
1	Mic #1 Mute	ON OFF Pulse
2	Mic #2 Mute	ON OFF Pulse
3	Mic #3 Mute	ON OFF Pulse
4	Mic #4 Mute	ON OFF Pulse

Below the table is a tree view showing the logic events for 'Logic Input Active 1':

- Logic Input Active 1
 - ON
 - EX-1280C (RTC): "EX-1280C 1"
 - Analog In 1 input 1: "Input 1"
 - Mute: "True"
 - OFF
 - EX-1280C (RTC): "EX-1280C 1"
 - Analog In 1 input 1: "Input 1"
 - Mute: "False"

An "On" state on Output #1 of Logic Input block triggers Mute on EX-1280C Analog input #1

Additionally, the outputs of the Logic Input block can be wired to the logic inputs of any logic-enabled block in the design, while at the same time triggering the pre-configured events described above.

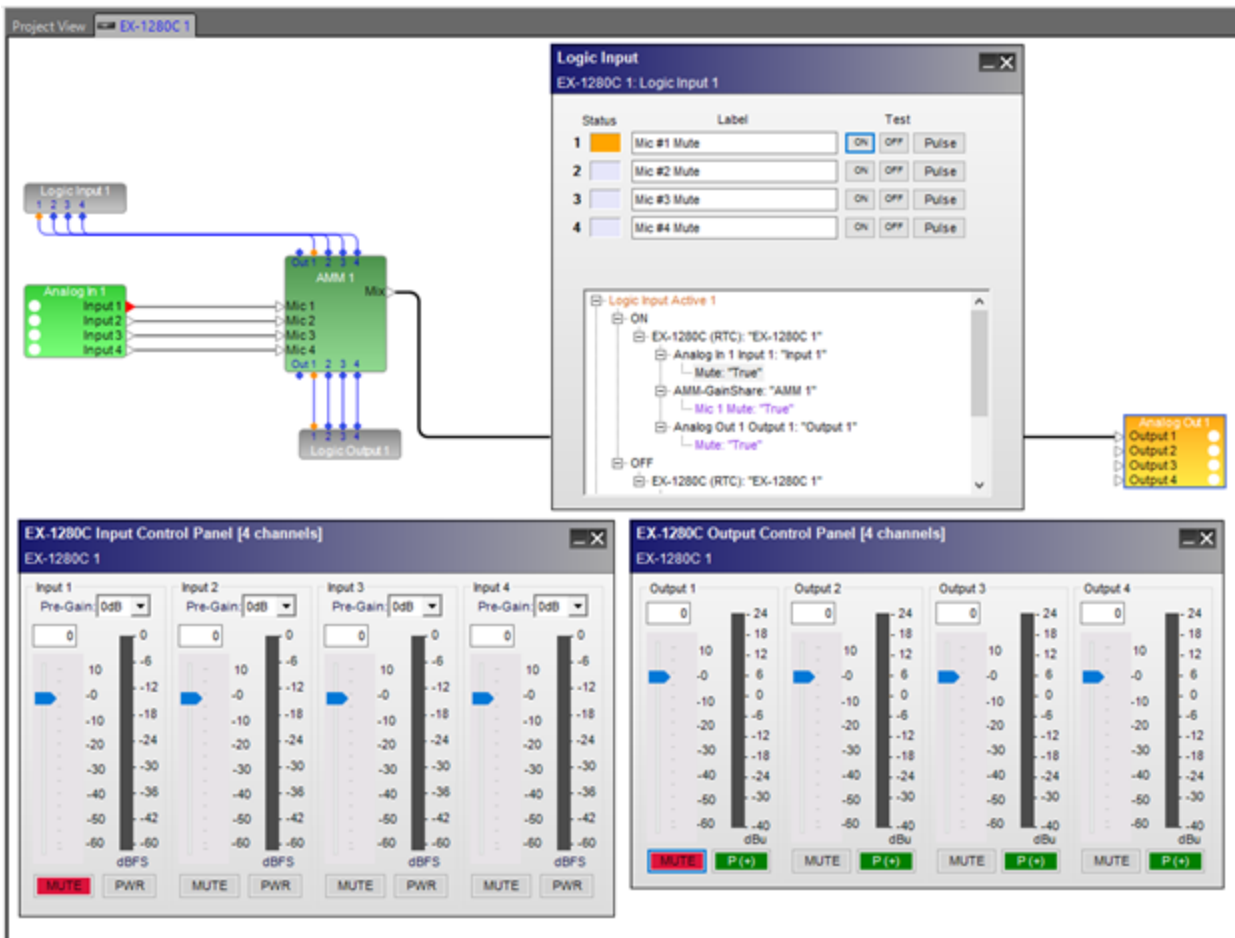

Same example as above but with Logic Input block outputs wired to AMM inputs

Logic Output Block

The inputs of a Logic Output block can be wired to another block's logic output(s) to report logic status to the user or to a third-party control system. Logic Output blocks do not trigger events - they only report On or Off states.

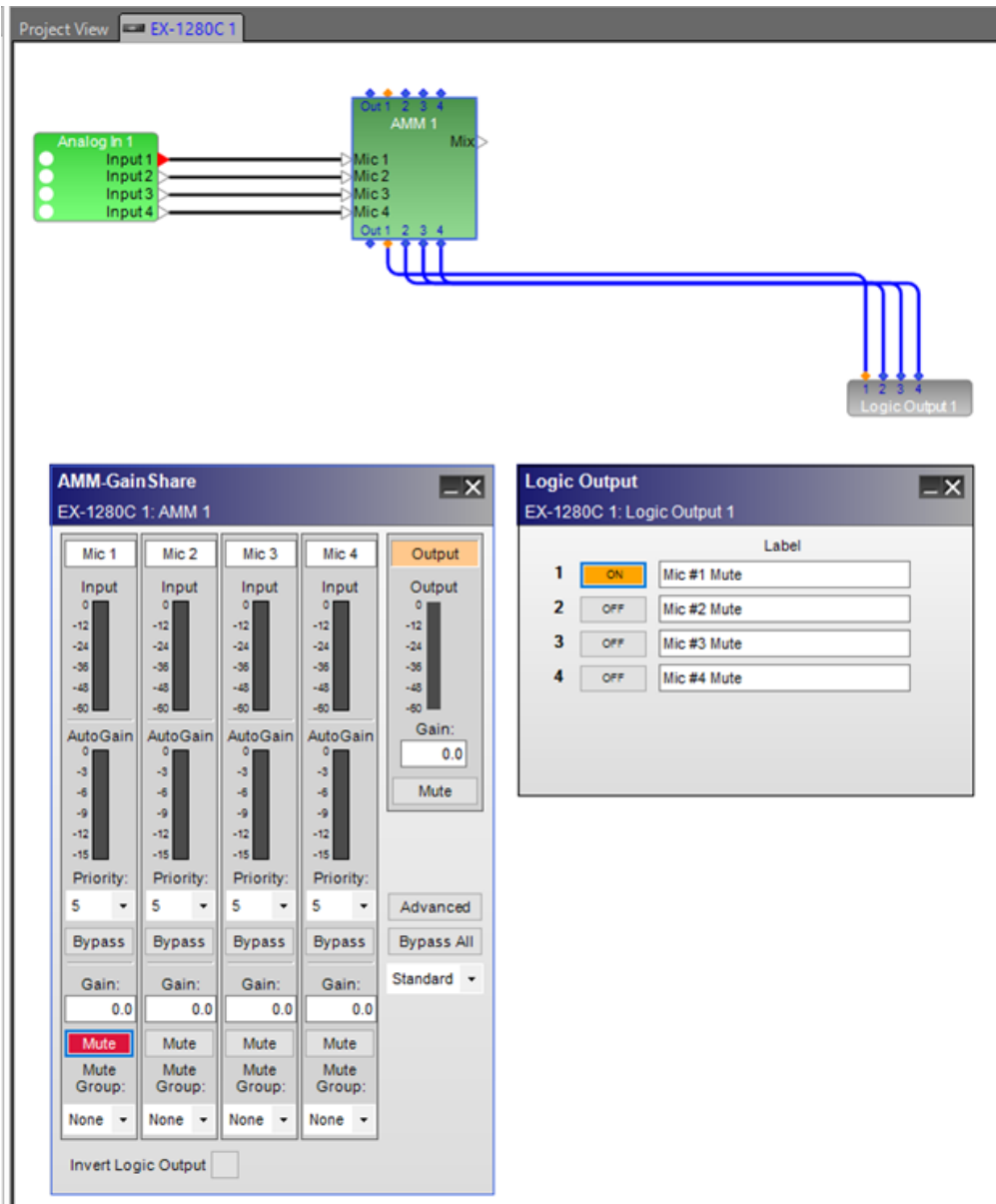

Logic Output block control panel reports On/Off status of AMM logic outputs

NOTE: To display the logic input/output ports for a block, right-click the block and select Show I/O Logic.

Setting the Number of Inputs

To set the number of input ports for a Logic Output block:

1. Drag the Logic Output block from the Logic/Control category in the SP Tool Kit into Signal Processing View.
2. In the Logic Output dialog, select or type in the number of input ports (up to 16 maximum), using the Inputs ports selector control.

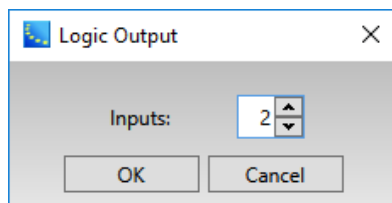

3. Click **OK** to add the block to the Signal Processing View.

You can add inputs to it at any time by right clicking on the block and selecting **Change input count**. You can then select the number of inputs to add, up to the maximum of 16.

Logic Output Block and Control Panel

Double-click on the Logic Input block in Signal Processing View to open its control panel.

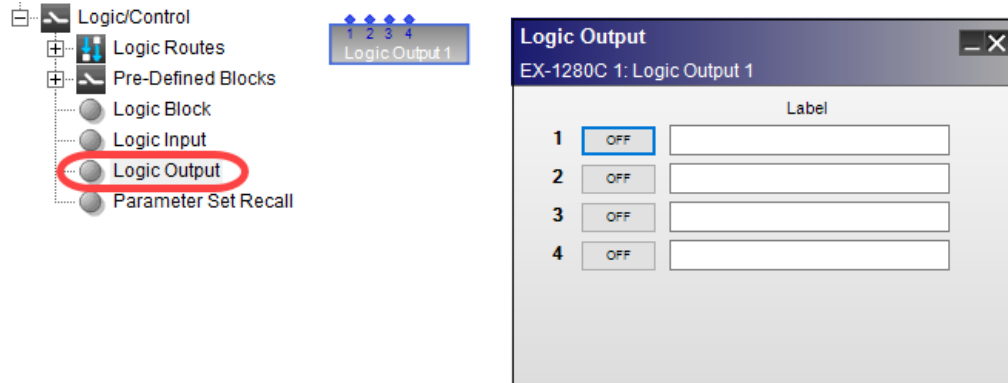

Logic Output block and control panel

Dante Endpoint and Microphone GP I/O Logic Support

The GPI and GPO blocks associated with Dante UTB endpoints EX-4ML and EX-8ML and those associated with Dante microphones are effectively the same, delivering the same functionality.

The output(s) of the GPI blocks can be connected to GPO blocks and other system functions via custom or pre-defined logic blocks to illuminate LED indicators, mute and unmute microphones, trigger presets, etc., on connected Dante devices or microphones.

NOTE: To display the logic input/output ports for a block, right-click the block and select Show I/O Logic.

Dante Microphone GP In Block



The GPI block for a Dante microphone in your design is tied to that microphone's physical pushbutton switch. When the pushbutton on the Dante microphone is pressed/released, the GPI output on the GPI block will go **On** or **Off**, indicating the pushbutton's state.

Dante Endpoint GP In Block



The GPI block for a Dante UTB endpoint in your design is tied to a non-Dante microphone's physical pushbutton switch (or to an external switch for microphones without pushbuttons) wired to a physical GPI input on the UTB endpoint. When a pushbutton or external switch is engaged on the non-Dante microphone, the respective GPI output on the GPI block will go **On** or **Off**, indicating the pushbutton's state.

NOTE: When a Dante UTB Endpoint's GPI block output is On, the corresponding (white) LED on the Dante UTB Endpoint will also illuminate.

Dante Microphone GP Out Block



The inputs on a Dante microphone GPO block are tied to LED indicators within Dante microphones. When input #1 on the GPO block goes **On**, the green LED indicator on the Dante microphone illuminates. When input #2 on the GPO block goes **On**, the red LED indicator on the Dante microphone illuminates.

Dante Endpoint GP Out Block



The inputs on a Dante UTB Endpoint GPO block are tied to LED indicators within the non-Dante microphones. When input #1 on the GPO block goes **On**, the green LED indicator on the non-Dante microphone illuminates. When input #2 on the GPO block goes **On**, the red LED indicator on the non-Dante microphone illuminates.

Parameter Set Recall Block Logic Support



When a Pset Recall block's logic input is set to **High** or is pulsed, the corresponding parameter set number within the block is recalled by the system.

NOTE: Right-click the block and select **Change input count** to configure the number of logic inputs (up to 16 maximum) that you can associate with parameter sets.

Setting the Number of Inputs

To set the number of logic input ports for a Pset Recall block:

1. Drag the Pset Recall block from the Logic/Control category in the SP Tool Kit into Signal Processing View.
2. In the Parameter Set Recall dialog, select or type in the number of input ports (up to 16 maximum), using the Inputs ports selector control.

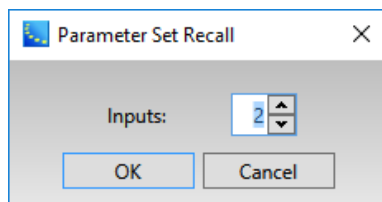

3. Click **OK** to add the block to the Signal Processing View.
You can add inputs to it at any time by right clicking on the block and selecting **Change input count**. You can then select the number of inputs to add, up to the maximum of 16.

Control Panel

To use the Pset Recall block control panel:

1. Double-click the block to open its control panel.

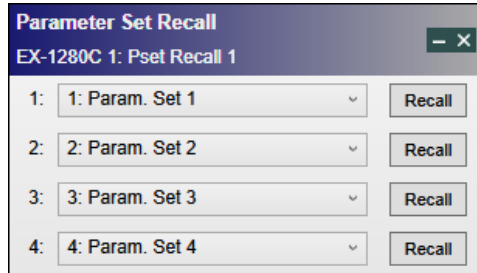

2. For each logic input, use the drop-down list to associate it with a parameter set number. You can use the **Recall** button in the control panel to simulate or recall a parameter set.

Control Centers

Control Center Programming

ControlSpace Designer software allows for a great amount of flexibility in how the user will control the system. The amount of programmed control depends on the system design, and the needs of your customer. Your system might be a static signal processor, and require no user controls, or it might be a multi-room, multi-zone solution requiring CC-1, CC-2, CC-3, CC-16, and CC-64 controllers, along with general purpose switches and potentiometers.

Each of the hardware devices has individual characteristics and programming requirements, as shown in the following table.

Control Type	Fully CW	Fully CCW	GPI Mode
CC-1	0 Ohms	10K Ohms	A-
CC-2	0 Ohms	10K Ohm	A- for Volume, D for switch selections
CC-3	10K Ohm	0 Ohms	A+ for Volume, D for switch selections

For information on programming these controllers, see:

[Programming CC-1, CC-2, and CC-3 Zone Controllers](#)

[Programming CC-16 Zone Controllers](#)

[Programming CC-64 Control Centers](#)

Programming CC-1, CC-2, and CC-3 Zone Controllers

The following provides programming information for the Bose CC-1, CC-2, and CC-3 zone controller interfaces. These controllers only have Project View icons and no dedicated control panels within Signal Processing View. They are all designed to connect via GPI ports.

For details on connections to GPI ports, see [Programming GPIO](#).

For details on programming GPI ports, see [Programming GPI](#).

CC-1 Controller



ControlSpace Designer supports the following programming feature via the GPI port for the CC-1 controller:

Volume Control - Drag and drop any Analog input/output, Gain, or Volume Group to an analog mode control for the GPI port to which this controller is wired. Be sure to select the **A-** mode for the volume control. Use the **A-** mode when the volume control potentiometer is 0 ohms (full counterclockwise) to 10 kilohms (fully clockwise).

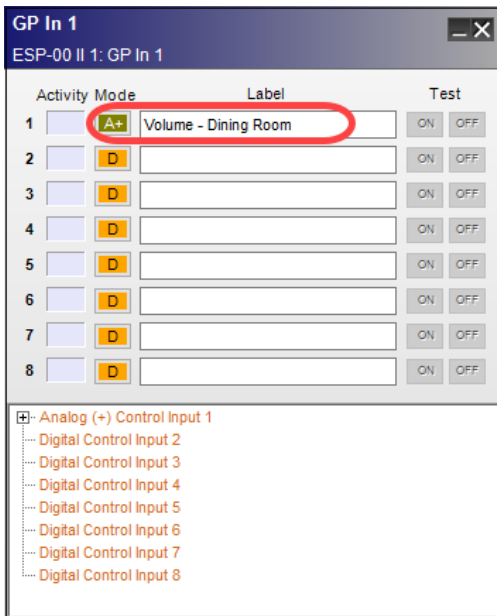

GPI Control Panel Example for programming the CC-1 controller

CC-2 Controller



ControlSpace Designer supports the following programming features via the GPI port for the CC-2 controller:

Volume Control – Drag and drop any Analog input/output, Gain, or Volume Group to an analog mode control for the GPI port to which the CC-2 controller is wired. Be sure to select the **A-** mode for the volume control. Use the **A-** mode when the volume control potentiometer is 0 ohms (full counterclockwise) to 10 kilohms (fully clockwise).

Selector Switch – Drag and drop any parameter set to two individual digital mode GPI controls for each switch position, A or B.

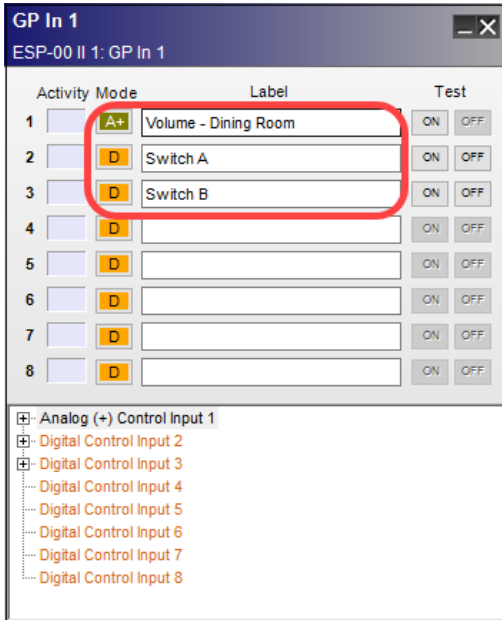

GPI Control Panel Example for programming the CC-2 controller

CC-3 Controller



ControlSpace Designer supports the following programming features via the GPI port for the CC-3 controller:

Volume Control – Drag and drop any Analog input/output, Gain, or Volume Group to an analog mode control for the GPI port to which the CC-3 controller is wired. Be sure to select the **A+** mode for the CC-3 controller. Use the **A+** mode when the volume control potentiometer is 0 ohms (full clockwise) to 10 kilohms (fully counterclockwise).

Selector Switch – Drag and drop any parameter set to four individual digital mode GPI controls for each switch position, A through D.

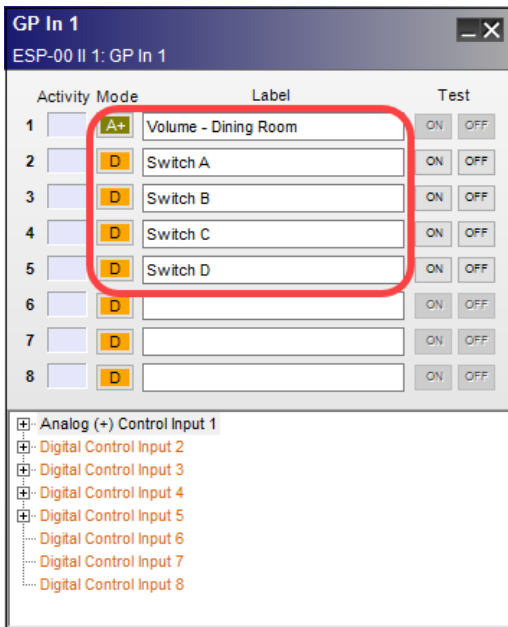

CC-3 Programming via GPI Analog and Digital Modes

Programming CC-16 Zone Controllers

Once a signal processing design is complete, programming associated controllers is accomplished using the same drag and drop methods as discussed in other programming topics. Open the CC-16 Smart Simulator by double clicking on its Project View icon.

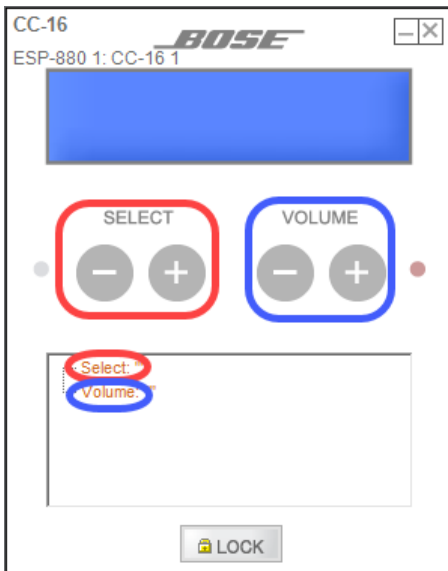

Programming tree functions of the CC-16 Smart Simulator

The buttons on the CC-16 can be programmed with the following objects:

SELECT buttons:

- Source Selector blocks
- Parameter sets

VOLUME buttons:

- Analog input/output, Gain, ESPLink, or AmpLink blocks
- Groups of Analog input/output, Gain, ESPLink, or AmpLink blocks

Select one of the appropriate block types listed above for use within the CC-16 Select buttons within Signal Processing View. Then, drag and drop that processing block onto the Select entry in the CC-16 programming tree. Repeat this process for an analog block or grouped analog blocks for Volume entry programming.

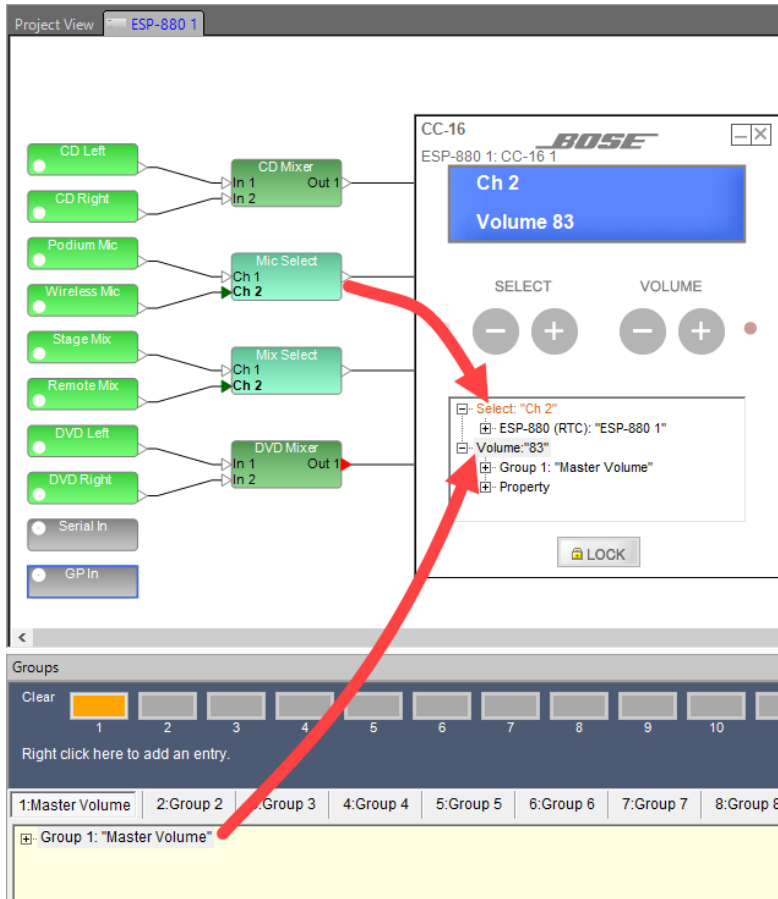

Assigning functions to CC-16 buttons

NOTE: Labels for the CC-16 display are inherited from the individual blocks, parameter sets, and groups. If the name is modified after adding the item to the CC-16, it must be re-assigned to the CC-16 for the new name to be applied.

Locking the CC-16

When locked, the select and volume control buttons of the CC-16 are disabled. The lock/unlock status of a CC-16 must be stored in two unique parameter sets, one for lock and one for unlock. When either parameter set is invoked, the CC-16 is either locked or unlocked accordingly.

To store the lock/unlock status in a parameter set, first set the lock button on the CC-16 Smart Simulator to the locked or unlocked state, then drag the CC-16 from Project View into a parameter set. The lock status is the only CC-16 setting that is stored in the parameter set.

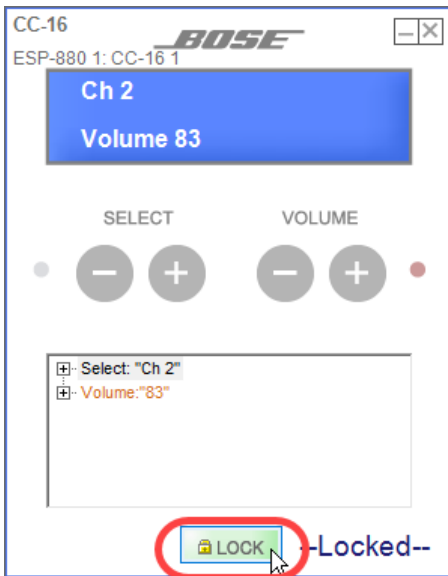

Setting the lock button on the CC-16 Smart Simulator

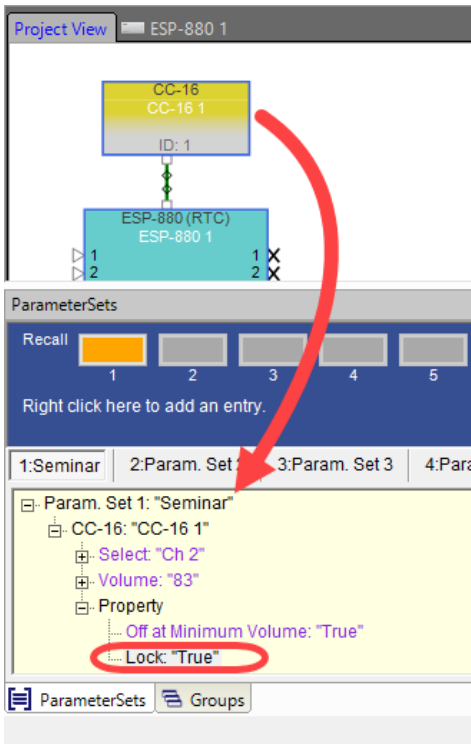

Dragging the locked CC-16 into a parameter set

Programming CC-64 Control Centers

The programming tree in the lower half of the CC-64 Smart Simulator is used for assigning functions to the controls on the CC-64.

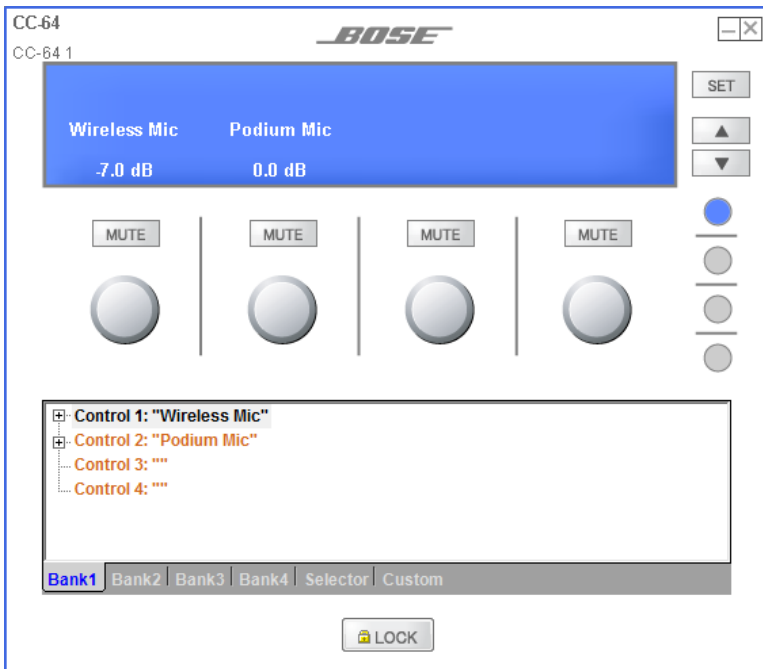

Programmable Controls for Bank1

This control center may be programmed to control or invoke the following objects:

- Analog input/output, Gain, ESPLink, or AmpLink blocks
- Grouped Analog input/output, Gain, ESPLink, or AmpLink blocks
- Source Selector blocks
- Parameter sets
- Certain signal processing blocks using custom settings

Once a signal processing design is complete, programming associated controllers is accomplished by dragging and dropping the desired processing object onto the appropriate user control.

When you open the Smart Simulator, the controls for Bank1 are displayed in the programming tree by default.

You may assign functions to controls 1-4, which correspond to control knobs 1-4, by dragging and dropping from Signal Processing View onto the appropriate controls in the programming tree.

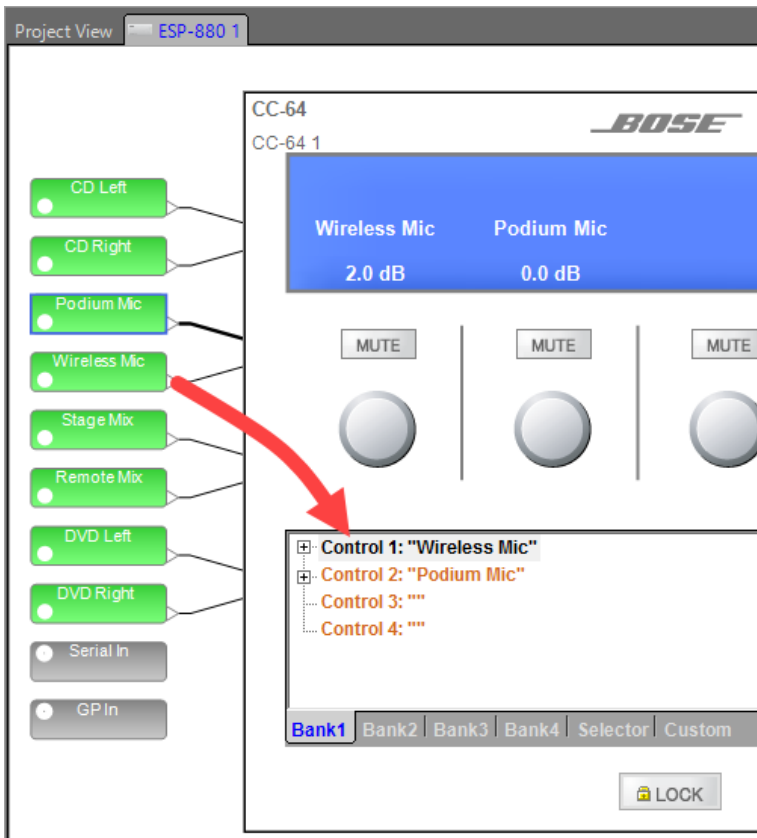

Dragging a sound processing block onto a Bank 1 control

To assign functions for the control knobs in Bank 2, select the Bank 2 tab at the bottom of the Smart Simulator window or press the Bank 2 selector button. Drag and drop functions onto the controls. The LCD display in the Smart Simulator shows what is displayed on the actual CC-64.

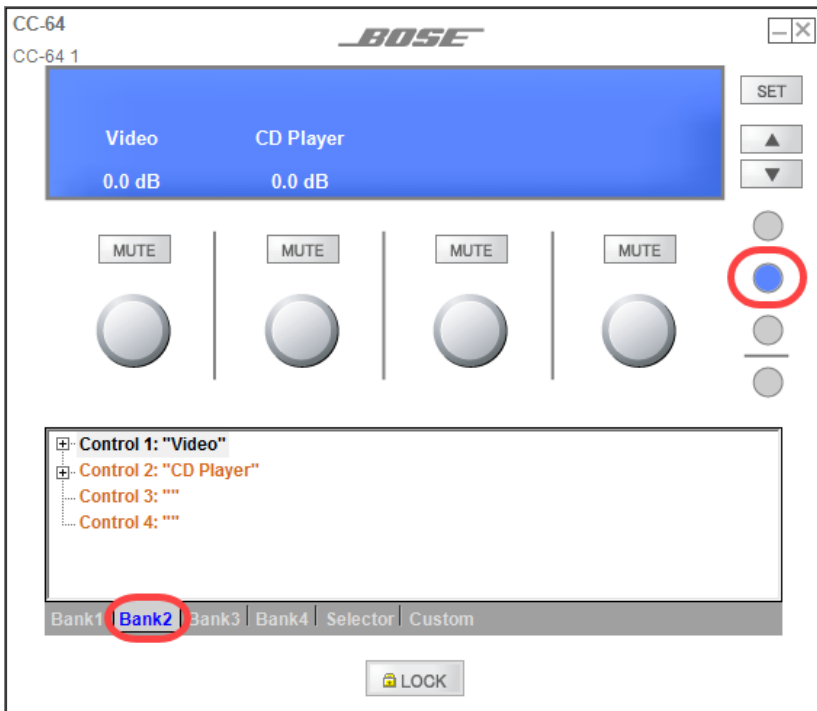

Assign functions to Bank 2

To assign functions to the Main Selector knob, choose the Selector tab at the bottom of the Smart Simulator window. Drag and drop a Source Selector block or parameter set onto the Selector in the Smart Simulator programming window. **NOTE: The Main Selector cannot be used as a volume or gain control.**

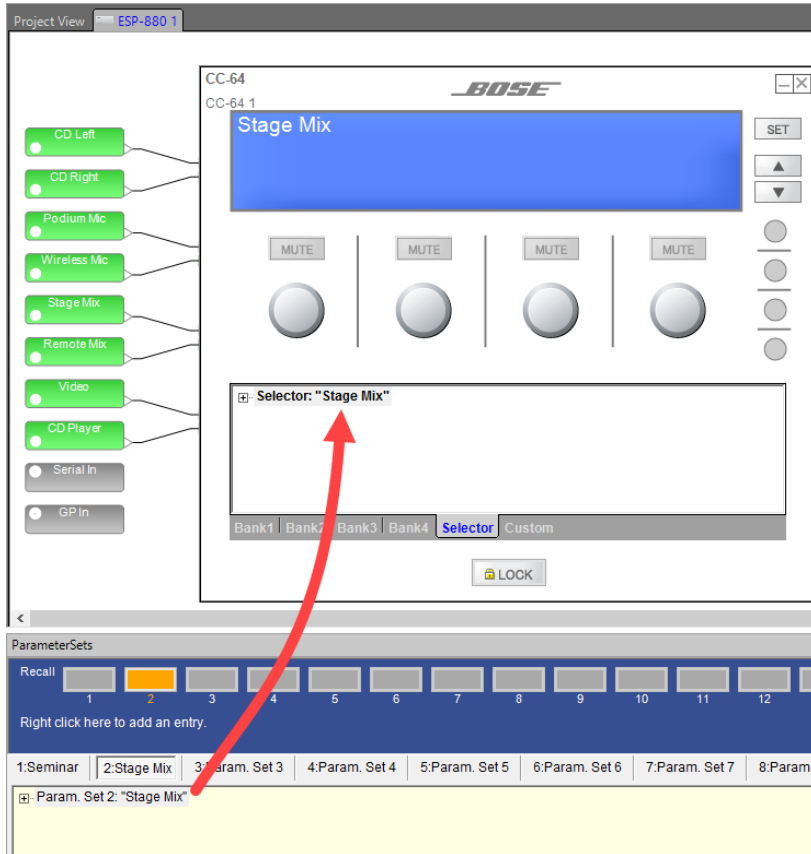

Dragging and dropping a parameter set into the Selector

Verify your programming by clicking on the Selector arrows in the Smart Simulator, which correspond to clockwise and counter-clockwise knob rotation, and then clicking the **Set** button. The display will switch between descriptions of any series of parameter sets assigned to the Selector.

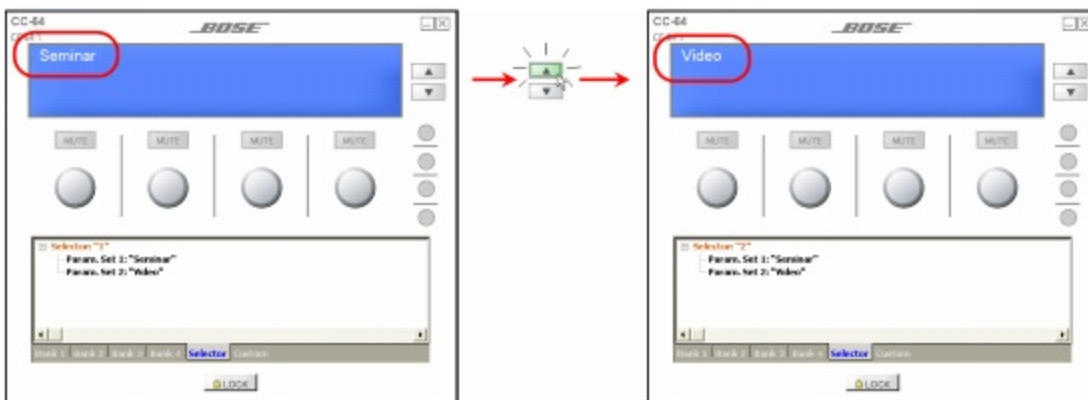

Testing the programming by switching between two parameter sets

A control knob may also act as a selector. If you program a control knob to invoke parameter sets or control a selector block, the control will change to selector arrows in the Smart Simulator.

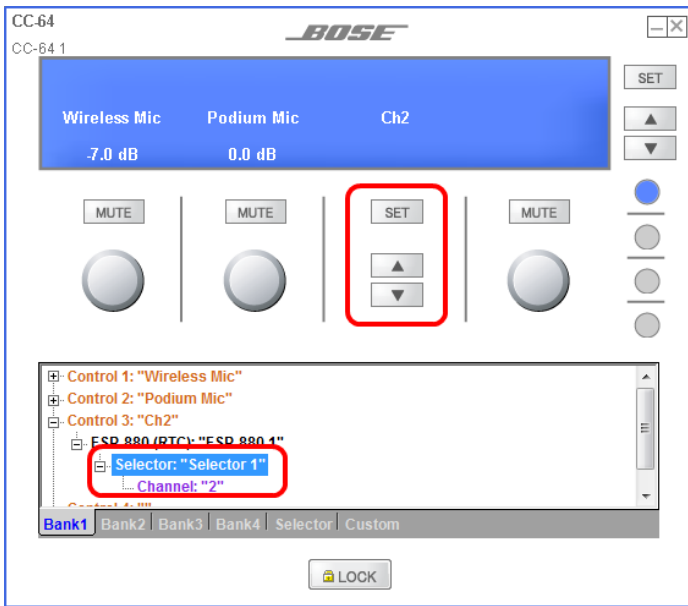

A control knob programmed to operate a selector

Changing the Selector Order

When a selector knob on the CC-64 is programmed with parameter sets, you have the option of changing the order in which the parameter sets appear. For example, you can program the CC-64 selector knob with four parameter sets as shown below:

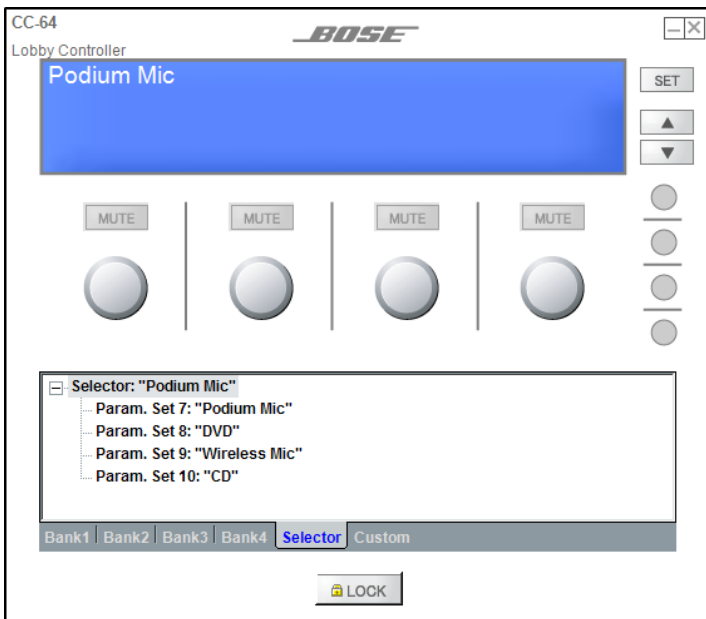

Programming the CC-64 selector knob with parameter sets

To change the order in which the parameter sets appear, double click on one of the parameter sets to open the Change Selector Index window.

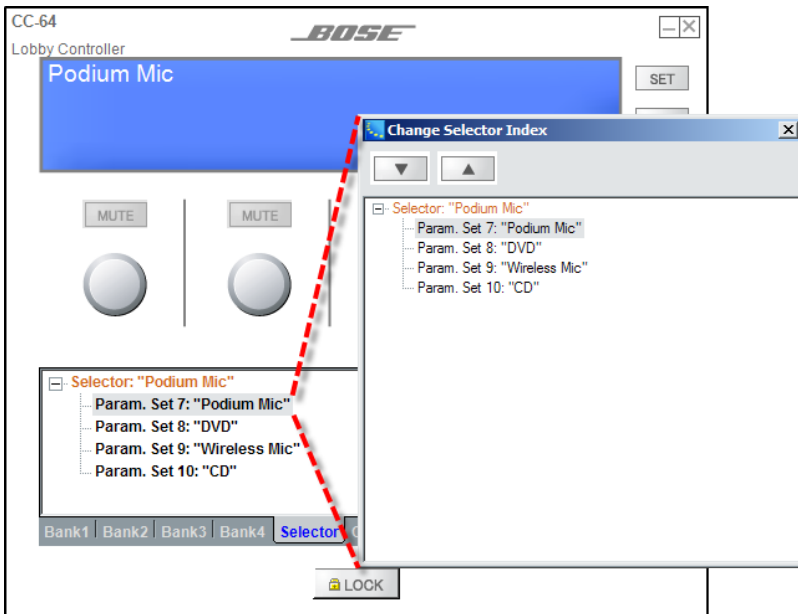

Double click a parameter set to open the Change Selector Index window

Use the arrow buttons at the top of the window to move the selected parameter set up or down in the list. In this window, you can select any of the parameter sets and use the arrows to change its position.

Another way to reorder the parameter sets is to drag and drop them within the CC-64 Smart Simulator window. For example, to move the “Podium Mic” parameter set to appear after the “DVD” parameter set, simply drag and drop the “Podium Mic” parameter set onto the “DVD” parameter set:

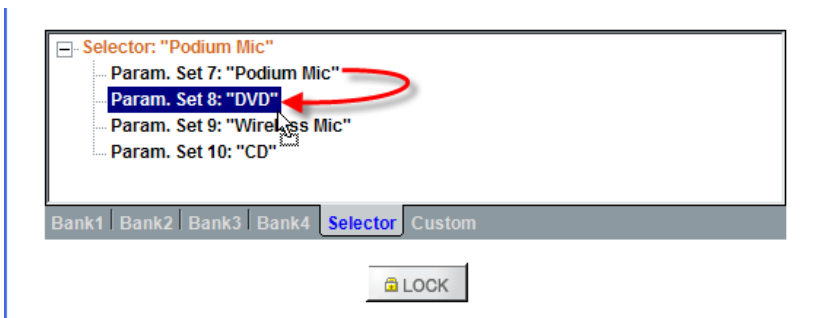

Dragging and dropping a parameter set to change the order

The list is reordered after the drag and drop operation.

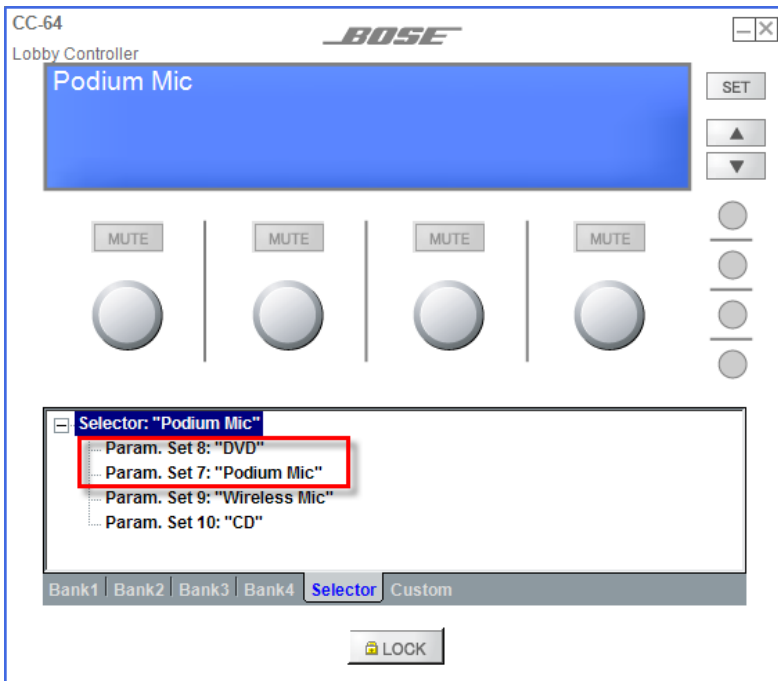

Newly Reordered Selector List

This technique may also be used within the Project Directory window. Locate the CC-64 selector settings in the Project Directory window, then drag and drop to new positions to reorder the parameter sets within that list.

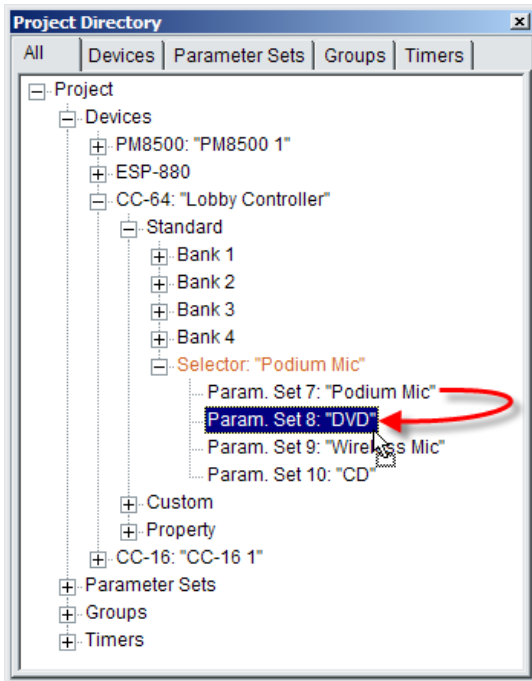

Reorder List Items in the Project Directory Window

Custom Settings

The CC-64 supports a custom mode, whereby you can access settings for certain signal processing blocks, such as EQ blocks and crossover blocks, by using a special button activation. You may program the CC-64 to control the following signal processing block types in custom mode:

- Crossover
- Graphic EQ
- Tone EQ
- Parametric EQ
- Delay
- Signal Generator
- Gain
- Analog input
- Analog output

To add signal processing blocks to the custom control, drag and drop one or more blocks listed above onto the Custom Tab of the CC-64 Programming Tree. The Smart Simulator displays the list of blocks assigned to custom control mode.

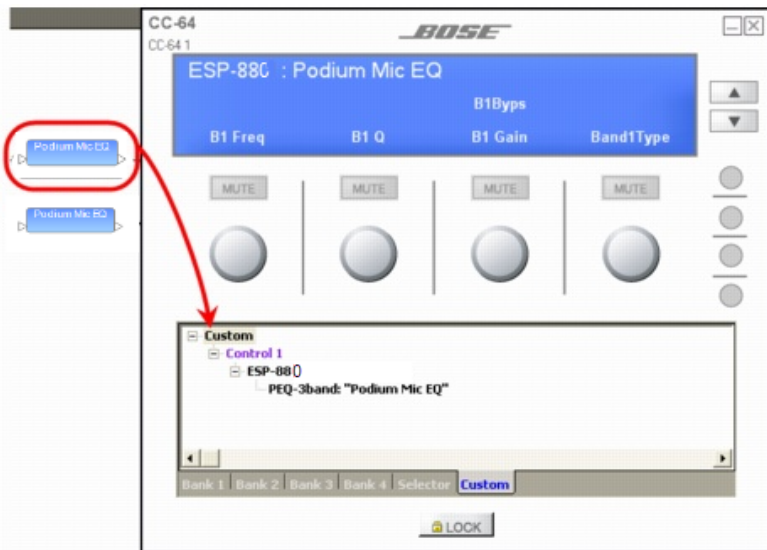

Dragging a Parametric EQ block onto a Custom control

NOTE: To access the Custom controls from the CC-64 hardware, press and hold the Selector knob for 5 seconds.

Locking the CC-64

When the CC-64 controller is locked, the user controls are disabled. This is very useful if you have multiple CC-64 controllers in your system and desire only one of the CC-64 controllers to be active at a time.

Consider a system configuration with two CC-64 controllers - one in a function room and another in a private office. During a crowded event in the function room, locking that control center prevents accidental change of system settings by unauthorized individuals. The master CC-64 located in the private office remains unlocked for performing system changes.

The lock/unlock status of a CC-64 must be stored in a parameter set. When this parameter set is invoked, the CC-64 is locked or unlocked according to the state stored in the chosen parameter set. To store the lock/unlock status in a parameter set, open the CC-64 Smart Simulator and set the lock state.



Enabling the CC-64 Lock

Next, open the Project Directory and locate the CC-64 Smart Simulator in the Device Tree. Expand the tree and drag only the Lock status property into a parameter set.

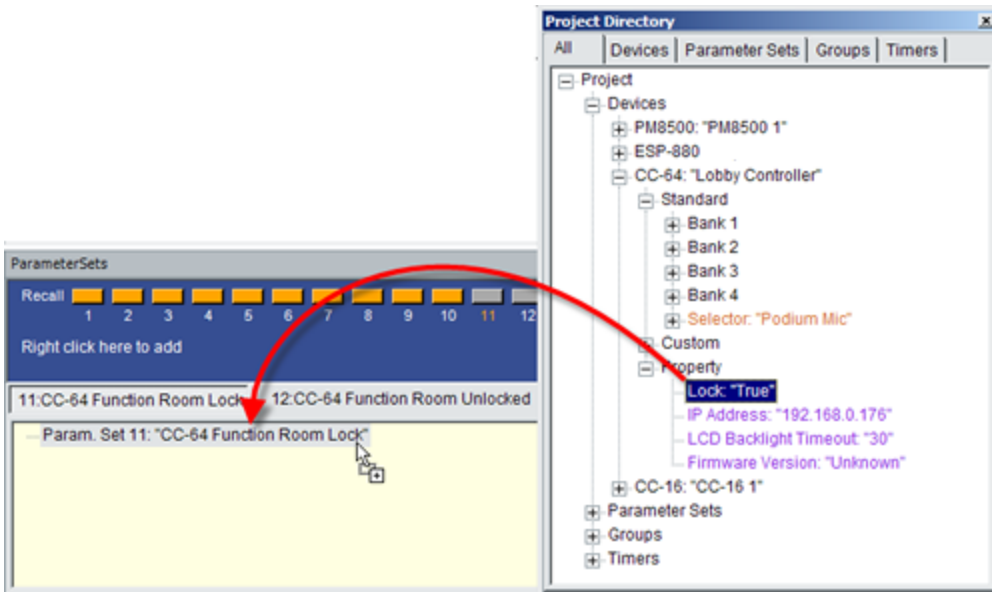

Creating a Lock CC-64 Parameter Set

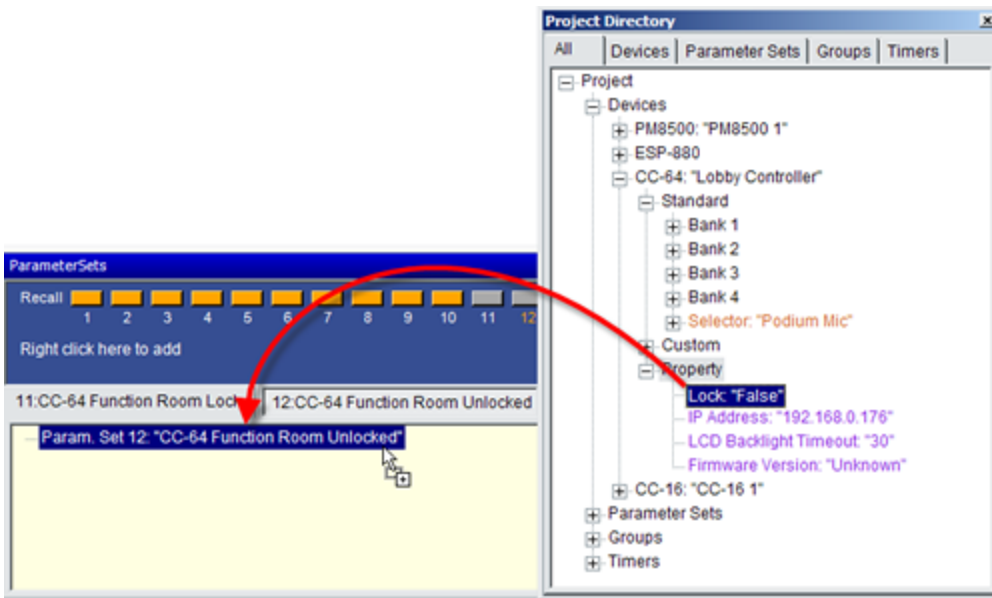

Creating an Unlock CC-64 Parameter Set

To create a parameter set to unlock a locked panel, repeat this process by opening the Smart Simulator and setting the unlock state. Then drag the updated Project Directory lock status property into a new parameter set.

CAUTION: Be careful not to add a parameter set to a CC-64 that locks itself unless you have another user control that can unlock the CC-64. Otherwise the user can become “locked out” of the system. Always add the unlock parameter set to an alternate user control (control panel, key switch connected to GPI, etc.) to ensure you can restore normal unlocked operation to the system.

Dynamic Controller Programming with Parameter Sets

The **CC-64** and **CC-16** controllers can be programmed to control or invoke the following objects in ControlSpace Designer software:

- Analog input/output, Gain, ESPLink, and AmpLink blocks
- Grouped Analog input/output, Gain, ESPLink, and AmpLink blocks
- Source Selector blocks
- Parameter sets
- Certain signal processing blocks, such as crossover and EQ, using custom settings in a CC-64

Once you have created your processing and control design, programming is accomplished by dragging and dropping the object to control onto the appropriate user control programming tree.

In ControlSpace Designer, you may also store different controller programming in separate parameter sets. When the parameter sets are invoked, the controller programming is changed.

Monitor Mode

ControlSpace Designer™ software versions 3.0 and above provide support for running the application as a stand-alone system monitor. When configured for monitor mode, all design and control programming functions are disabled and a system connection is automatically established at application launch. Monitor mode provides the system owner with a convenient operational overview of all system devices, and virtual operation of system controls such as the CC-16 and CC-64 control centers.

Monitor mode is invoked by appending a command line parameter to the Target field of the application shortcut. To configure the application for monitor mode, create a shortcut for the ControlSpace Designer application or copy the existing shortcut for modification. Select the Properties item from the application shortcut’s right-click menu. At the end of the application target location, add the parameter “[space]-m” outside the quotes as shown in the following example.

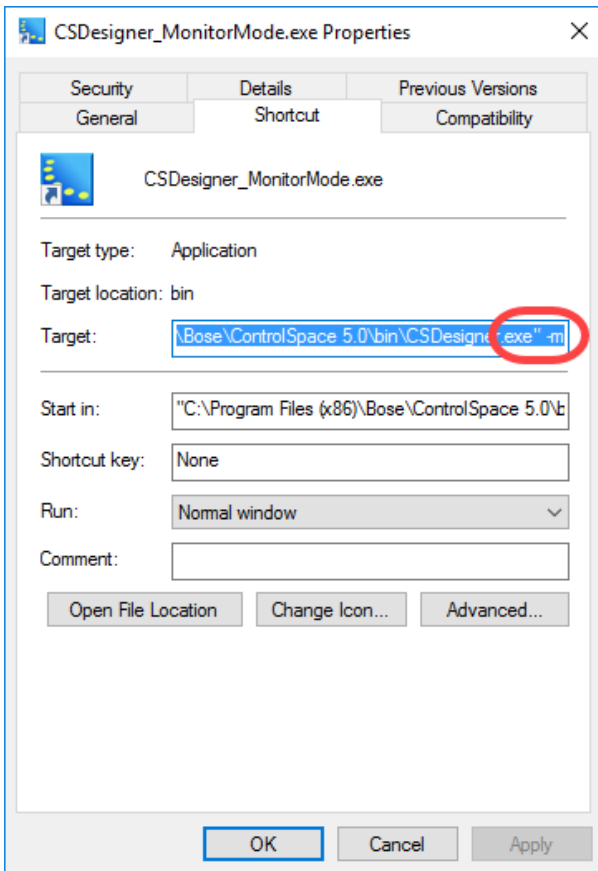

Creating a Monitor Mode Shortcut

Launch ControlSpace Designer from this modified shortcut to activate monitor mode.

Once Monitor Mode is active, all design functions are removed and the ControlSpace Designer application remains in monitor mode for all subsequent application launches using the modified shortcut.

When in monitor mode, a system connection is automatically established when a design file is loaded and the running state of all system devices is retrieved and displayed within Project View.

To exit monitor mode, close ControlSpace Designer software and restart the application using the standard shortcut.

Estimating DSP Usage

Estimating DSP usage in a system design is accomplished by accessing the DSP Resources dialog box.

Select the signal processing device icon in Project View or an SP block in the Signal Processing View, then click the **DSP Resources** tool in the Main Toolbar.

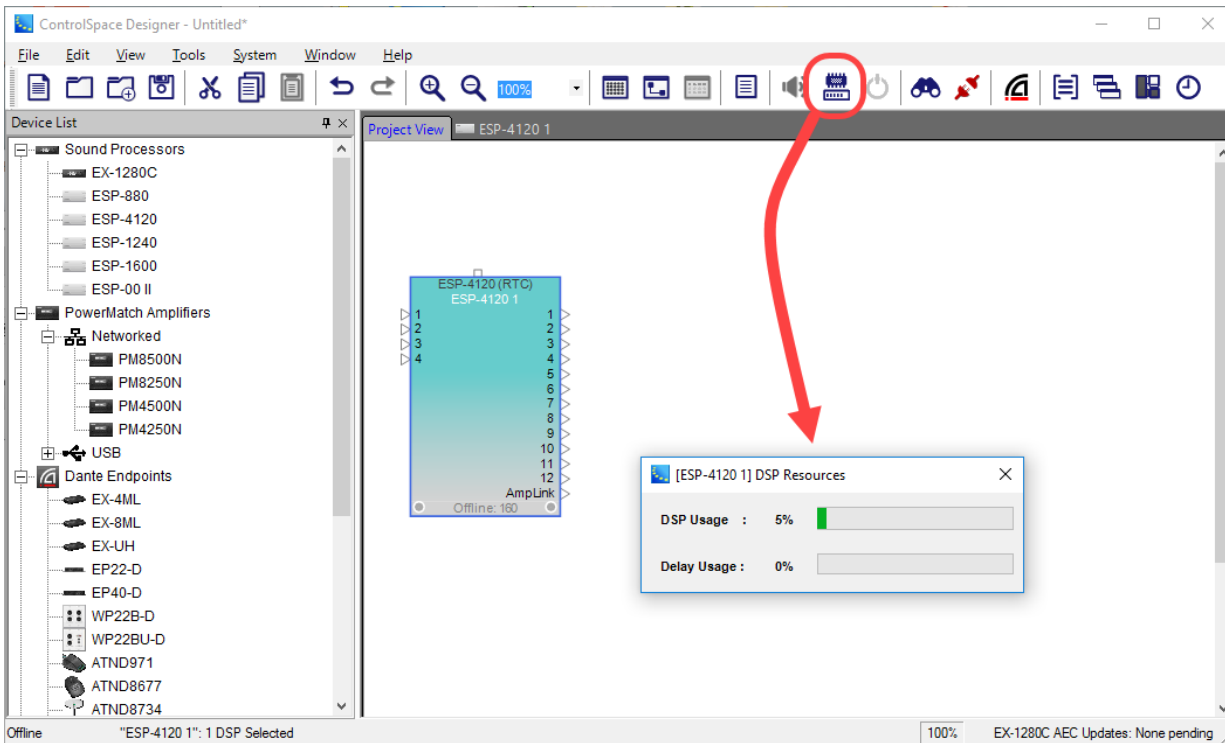

DSP Resources dialog box

The DSP Resources dialog box displays the following information for the selected signal processing device or block:

- DSP Usage – Indicates the current percentage of capacity used for signal processing along with a horizontal bar graph.
- Delay Usage – Indicates the current percentage of capacity used for signal delay along with a horizontal bar graph.

Maintaining Your System

Protecting System Settings

Password protection secures ControlSpace Project (.CSP) Files from unauthorized access by prompting the user to enter password each time this file is opened by ControlSpace Designer. When a password-protected configuration is uploaded to a sound processor or PowerMatch amplifier, it inherits the password protection stored in the CSP file.

Password-protected systems will not accept new CSP uploads or downloads unless the user enters the correct password. Opening a password-protected CSP file or attempting to go online with a protected sound processor displays the following prompt.

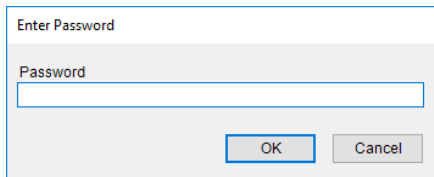

Password Prompt

Protecting a Project (.CSP) File

To enable password protection, select **Set File Password** from the Tools menu.

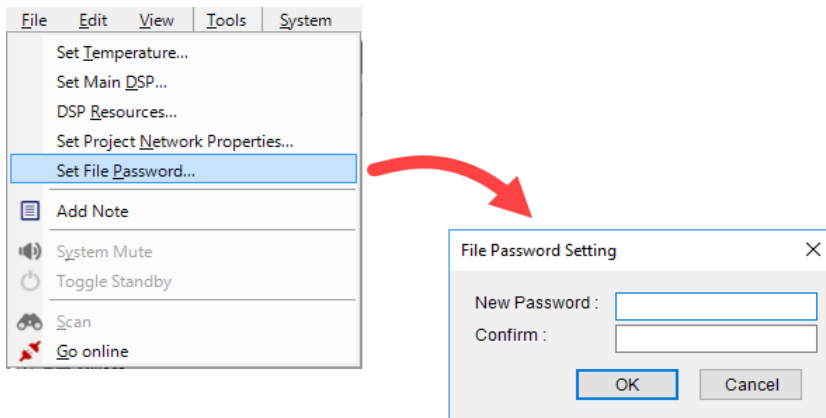

Tools Menu - Set File Password

Options for the File Password Setting dialog are as follows:

New Password – text field to type a password. The password may be any length word, phrase, or number combination.

Confirm - enter the new password again. This is a text field to verify the new password is entered as intended.

NOTE: Saving an unprotected back-up copy of the configuration file to a secure location **before** using the password protection option is highly recommended. It is possible to lock yourself out of your own configuration file if you lose or forget the password.

Saving Password-Protected Project Files

Saving new Project Files to local storage after entering password settings will store a password-protection encryption key in the file. Thereafter, the Project Files may not be opened or changed without first entering this password.

Uploading Password-Protected Project Files

When a password is stored in a Project File, uploading that file to a sound processing system will protect the file within the hardware until that password is disabled. All subsequent file transfers to and from that sound processing system will require entry of this password.

Downloading Password-Protected Project Files

If a password-protected Project File is stored within a sound processing system, you must enter the correct password when retrieving the file. Go online with the sound processor, choose the **Get from devices (download design)** option, and select either the **Running** or **Saved** options to access the password prompt.

If an incorrect password is entered, the software responds with an error. A valid password must be entered before proceeding.



Invalid Password Error

Uploading New Project Files To Protected Systems

Once a password is enabled for a Project File, uploading that file to a sound processing system by going **online** will protect the file within the hardware until the password is disabled. All subsequent file transfers to and from a sound processor require the entry of this password.

Changing or Disabling Passwords in Protected Project Files

The password of a protected Project File can be changed or disabled in either **online** or **offline** modes by selecting **Set File Password** from the Tools menu. You are first prompted to enter the old password before proceeding.

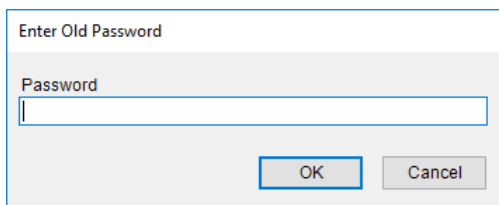

Old Password Prompt

After entering the old password and clicking **OK**, to change the password, enter the new password and confirmation in the File Password Setting dialog and click **OK**.

To disable password protection entirely in a CSP file, do not enter any password or confirmation in the File Password Setting dialog (or remove any existing characters from these fields to ensure they are empty) and then click **OK**. Then save the CSP file.

Retrieving System Configurations

Two System menu functions are available within the ControlSpace® Designer™ software which allow you to retrieve the saved project file while in offline mode (not connected to the sound processor or amplifier):

- **Retrieve Saved Design:** Retrieves the project file while offline from the sound processor or amplifier. Note that you must have an active network connection to enable this function.

- Save Retrieved Design to File:** Retrieves the project file while offline from the sound processor or amplifier, and prompts you to save it as a file locally. Note that you must have an active network connection to enable this function.

Retrieving a Saved Project File

A copy of the original ControlSpace Project file is stored within each signal processing device on the network, (ESP, EX-1280C, and PowerMatch amplifier). The Project File contains the original system design and control programming, and represents the “power on” state of the system. To retrieve the saved Project file:

1. Select **Retrieve Saved Design** from the System Menu.

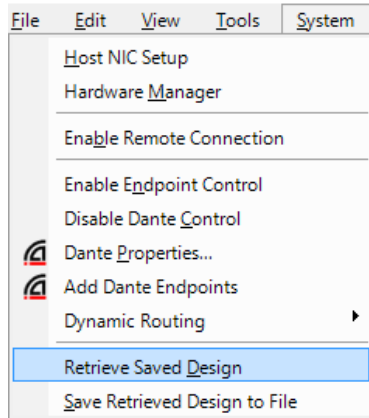

2. From the list of available system devices, select the device from which you would like to retrieve the Project file and click **OK**.

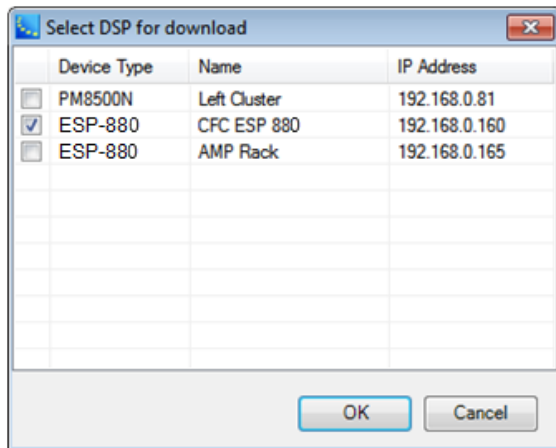

3. The Project file is retrieved and displayed. At this point it is possible to either save the file directly to the PC, or initiate an online connection to the sound processor.

Saving a Retrieved Configuration to File

CSP files stored in hardware using a version of ControlSpace Designer older than v3.0 cannot be read without first saving them to local PC, and re-opening the file within ControlSpace Designer.

When connecting to the system, if you receive the following error message, use the steps outlined below to retrieve the file and connect to the system.

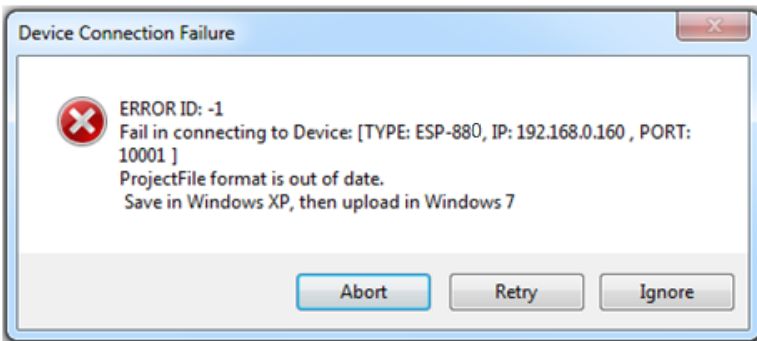

1. Select **Save Retrieved Design to File** from the System Menu.

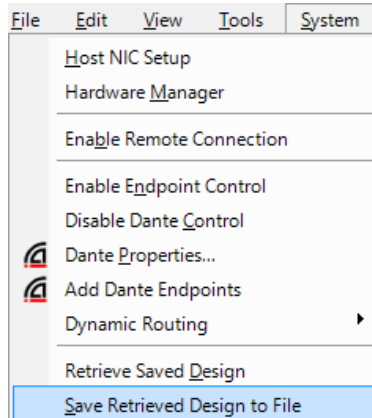

2. From the list of available system devices, select the one from which you would like to retrieve the Project file, and click **OK**.

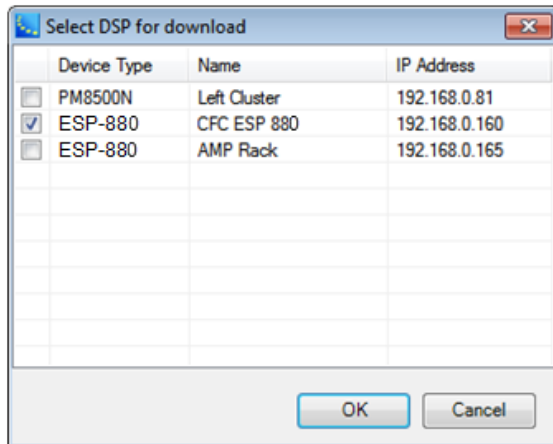

3. Select a location and name for the system design file and click **Save**.

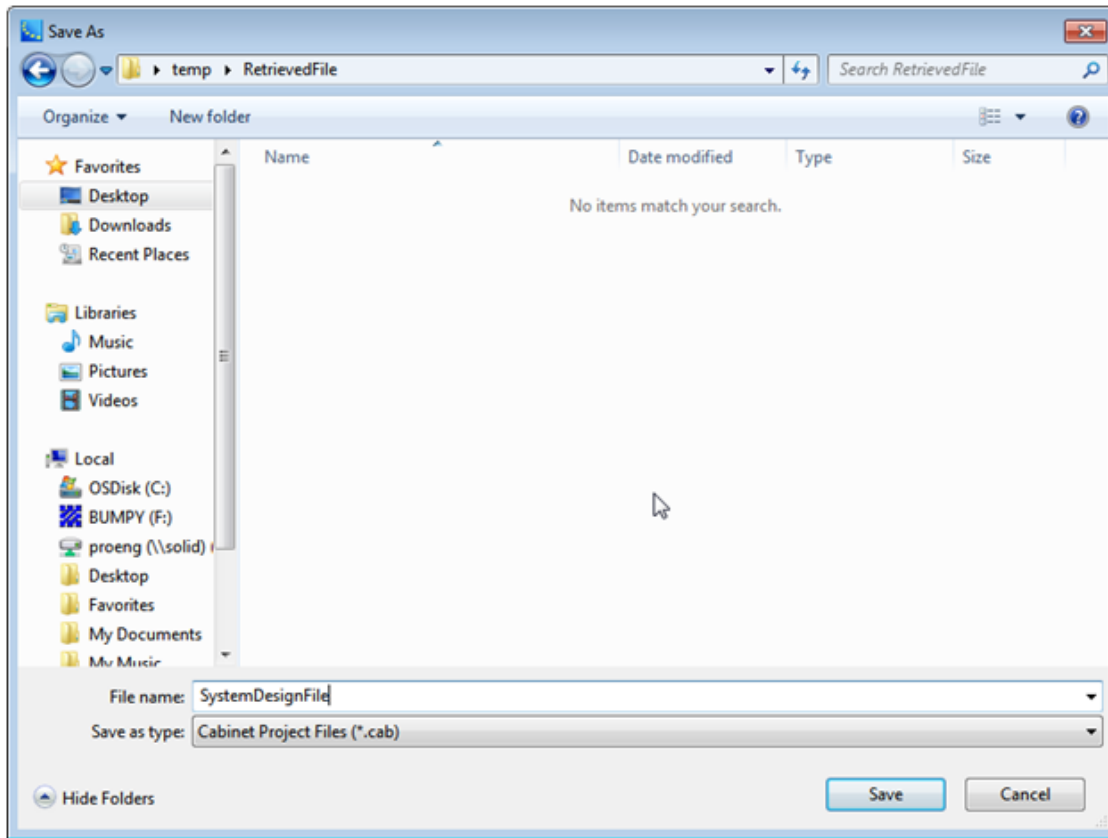

- Navigate to the file that was retrieved from the system and open it. The file is stored in a compressed file format (.cab) and can be opened directly from the Windows desktop.

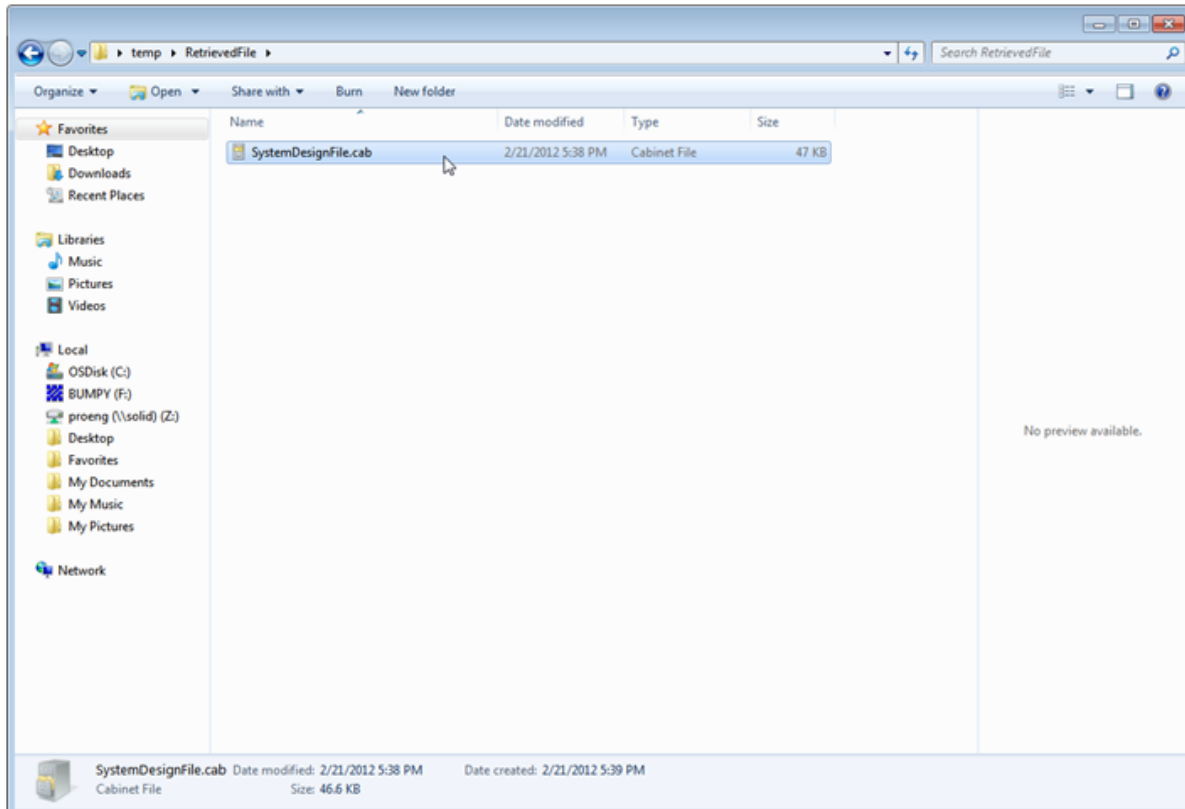

- Copy the file to the desktop, and rename it "SystemTransfer.csp." You will receive a warning asking if

you wish to change the file extension. Click **OK**.

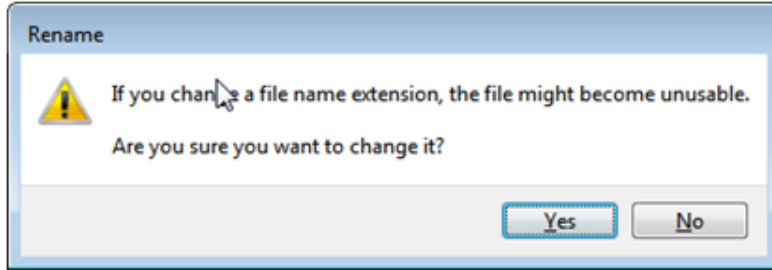

Once the file and its extension are changed, the file will become associated with the ControlSpace Designer software. You can now open the file from within ControlSpace Designer using the **File > Open** command.

NOTE: For additional information on this topic, see the "Project File format is out of date" error on the ControlSpace User's Forum knowledge base.

Updating Firmware in Bose® Devices

The ControlSpace® ESP, EX-1280C, PowerMatch® power amplifier, CC-64 Control Center, and CC-16 Zone Controller interfaces require firmware to control their operation. Firmware is programming that is stored in Flash memory and is not erased when the power is turned off. On occasion, it is necessary to update this firmware to fix problems or improve features.

To update firmware, you will first need to get the new firmware file. The best method is to simply download the latest version of ControlSpace® Designer™ software from the Bose Professional Systems Division web site.

Follow these steps to update the firmware:

1. Make sure all ControlSpace devices are powered on and connected using Ethernet cables to the port of the network switch.
2. Make sure the switch is connected to the DHCP router using an Ethernet cable.
3. Visit pro.bose.com on the web and browse to the software downloads area of the ControlSpace Systems product area.
4. Locate the latest version of software and download the installation package to your local PC.
5. Launch ControlSpace Designer software version 5.0 or later.
6. Launch the Hardware Manager (see [Launching the Hardware Manager](#)) and go to the Firmware Update tab in the [Device List Tabs](#).
7. Make sure the device is selected in the Firmware Update tab and click **Update**.

Loudspeaker EQ updates (PowerMatch only)

You can update the loudspeaker equalization (EQ) database independent of the ControlSpace® Designer™ application. Steps to update the loudspeaker EQ database are listed below.

Determining Current Loudspeaker EQ Database Version

From within the ControlSpace Designer application, access the Help menu and select **About ControlSpace Designer**. The current loudspeaker database version, Speaker Data, is shown beneath the application version at the bottom of the window.



About ControlSpace Designer Screen

If a newer version of Speaker Data is available, follow the steps below to update ControlSpace Designer.

Updating the Loudspeaker EQ Database

1. Download the latest version of the Bose loudspeaker equalization database for ControlSpace Designer software. The most recent database version is always available for download at pro.Bose.com.
2. Transfer the new *Speakers.xml* and *DeviceList.xml* files contained within the update archive to the ControlSpace designer application folder on your PC.
3. Locate the current ControlSpace Designer application directory. This is typically “C:\Program Files (x86)\Bose\ControlSpace <version>”.
4. Open the \bin directory within the ControlSpace Designer application directory.
5. Rename the existing *Speakers.xml* file *OldSpeakers.xml* and *DeviceList.xml* to *OldDeviceList.xml*.
6. Transfer the new *Speakers.xml* and the *DeviceList.xml* files to the bin directory.
7. Once the files have been copied, the new Bose loudspeaker EQs will be available within the ControlSpace Designer software after the application restarts.
8. Launch the **Hardware Manager** and go to the EQ Update tab in the **Device List Tabs**.
9. Make sure the device is selected in the EQ Update tab and click **Update**.

NOTES AND CAUTION:

- This method of updating the loudspeaker equalization database is used primarily to support the introduction of new loudspeaker products. However, in some cases a new loudspeaker equalization curve may be provided for an existing loudspeaker product.
- In cases where a new EQ is provided for an existing product it may be necessary to upgrade the entire existing CSD installation or design to ensure compatibility with the latest equalization version.
- Any custom devices that have been added to ControlSpace Designer will be lost on transferring the new *DeviceList.xml* file. You will need to manually copy any custom devices from the *OldDeviceList.xml* into the new *DeviceList.xml* file.

File Types

ControlSpace[®] Designer™ uses the following file types with specific extensions to define their function:

Extension	File Type
.cab	Archived (compressed) .csp file
.csp	ControlSpace Designer project files (raw xml)
.exe	Executable program files (binary)
.frm	ESP, EX-1280C, & PowerMatch firmware files (binary)
.hex	CC-16 firmware files (binary)
.mot	CC-64 firmware files (binary)
.peq	Parametric Equalization files (raw xml)
.seq	Speaker Equalization files (formatted xml)
.spt	Serial preset file
.xml	Device List and Loudspeaker Database files (formatted xml)

Appendix

ControlSpace Networks - Advanced Operations

Remote Network Control

ControlSpace networks can be operated using remote devices via a router-to-router connection.

Router to Router connection

In order for CSD to communicate with remote devices, you need to follow particular steps before you can scan, upload, download, etc.

In the following example, the local network will be within the 192.168.0.xxx range, while the remote network will be within the 192.168.1.xxx range. The PC with ControlSpace Designer software is within the local range while all ControlSpace hardware is on the same network.

Example Setup:

- Laptop PC NIC: IP = 192.168.0.10 /24; Gateway = 192.168.10.11
- Router 1 (Linksys): LAN = 192.168.0.1; WAN = 192.168.10.10
- Switch (D-Link)
- Router 2 (TP-LINK): LAN = 192.168.1.1; WAN = 192.168.10.11
- CSD Project and Devices: IP = 192.168.1.x /24

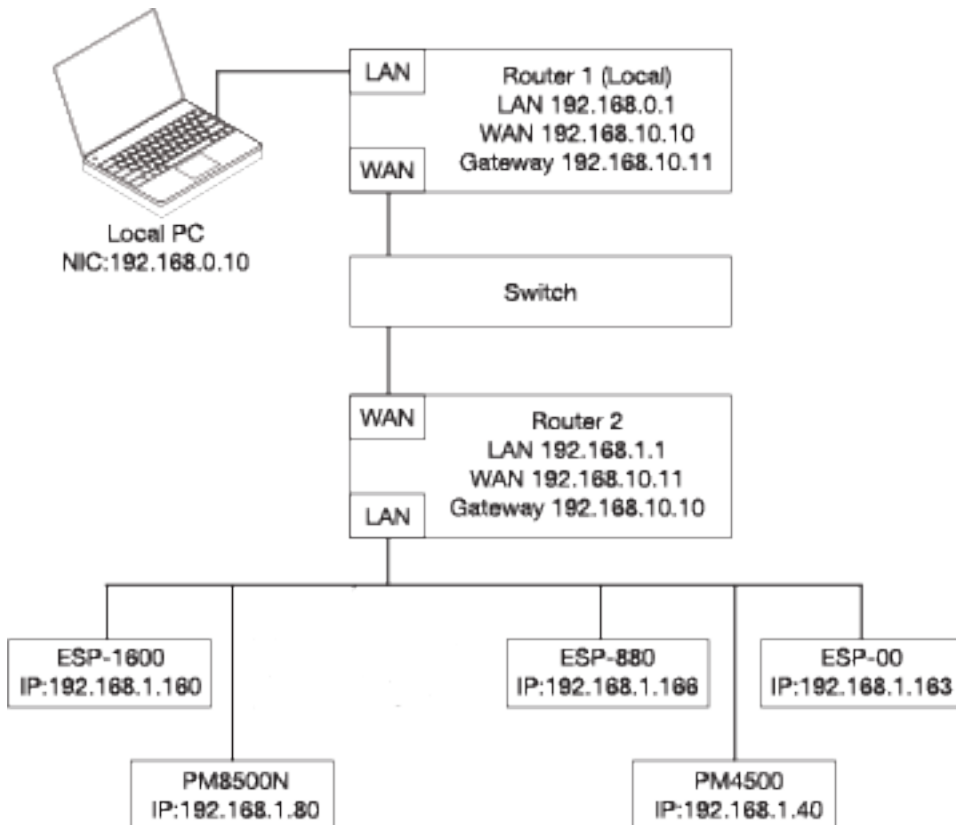

NOTE: You do not need to change the IP address of your local NIC.

First, CSD must be set up to communicate with the remote network. If remote communication is not already enabled, select **System > Enable Remote Connection**. Upon transitioning between remote mode

and local mode, you will be offered the opportunity to save your current design before starting with an empty new design.

Next, select **Tools > Set Project Network Properties**. After the dialog is open, change the New Project Network Address to match the remote network.

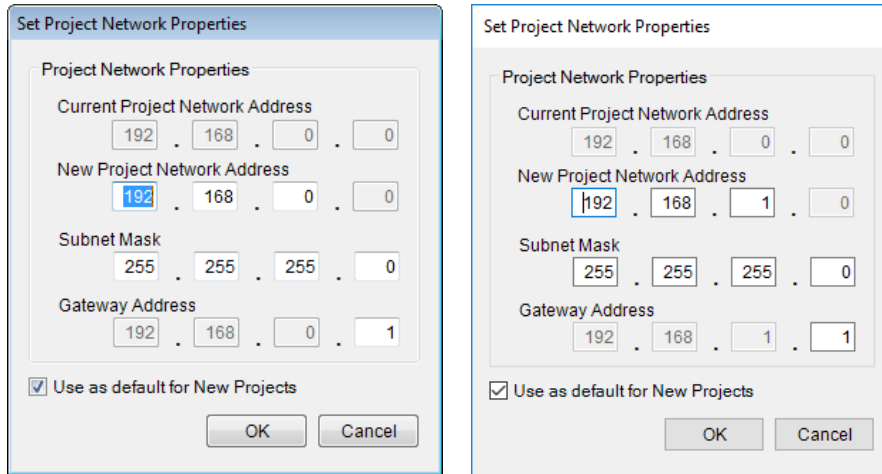

Dialog before change

Dialog after change

Click **OK** and close the dialog. CSD will now look to the remote network for devices.

Remote Mode

Project Files can be loaded from a device on the remote network that will be used to communicate with all of the devices on that network. To do this, there must be at least one ControlSpace device on the remote network with a known IP Address. CSD will not be able to communicate with remote devices without this. To see all devices on the remote network, there must be at least one ControlSpace device (typically the RTC/Main device) that has been loaded with a Project File containing those other devices.

When in Remote Mode, the remote connection icon appears in the toolbar.



Likewise, the System Menu indicates a remote network connection.

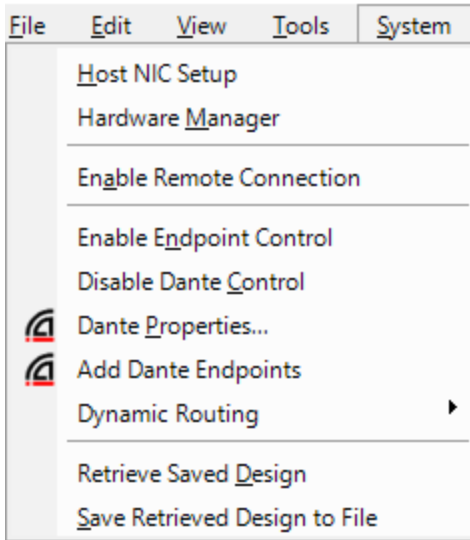

System Menu - Not in Remote Mode

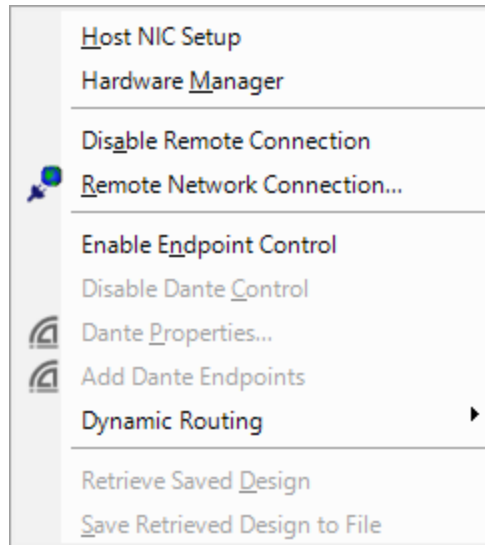

System Menu - In Remote Mode

Ideally, one device in the example meets the criteria to communicate with all devices on the remote network - a known IP address and a Project File with all of the remote devices.

Connecting With Remote Devices

1. After selecting **System > Enable Remote Connection**, select **System > Remote Network Connection** to launch the Remote Connection dialog.

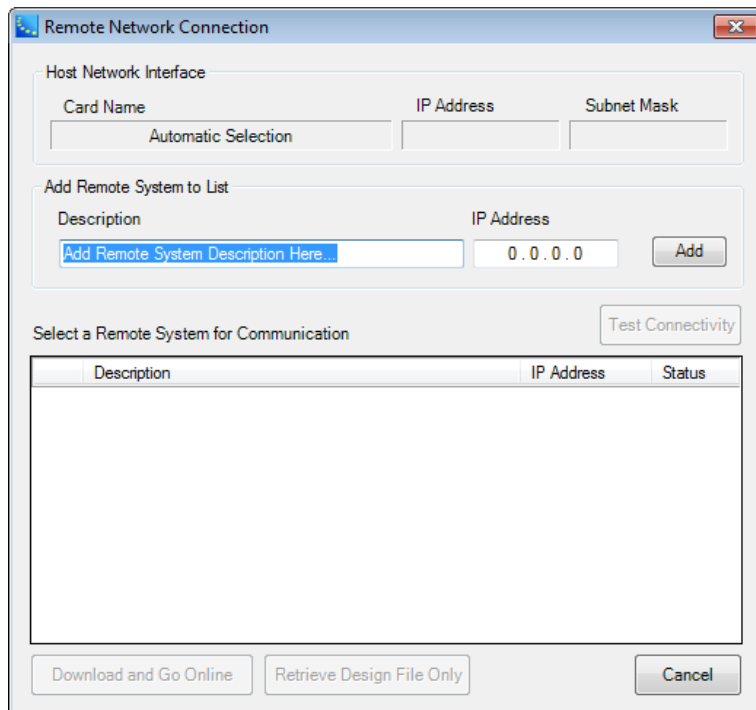

2. Enter a description of the remote device to be connected to in the **Description** box.
3. Enter the known IP Address of the device into the **IP Address** box and click **Add**.

The device is now added to the list of remote devices. Once that device is in the list, you can click **Test Connectivity**. This will show if there is a valid point-to-point connection to the remote device. If the **Status** box is Green, there is a valid connection. If it is Red, the connection is invalid. Note that an item can be removed from the list by selecting the right-click context menu **Remove** option.

This dialog can be used to easily communicate with any number of installed systems by entering the system name in the description box and/or the IP address of any device in the system.

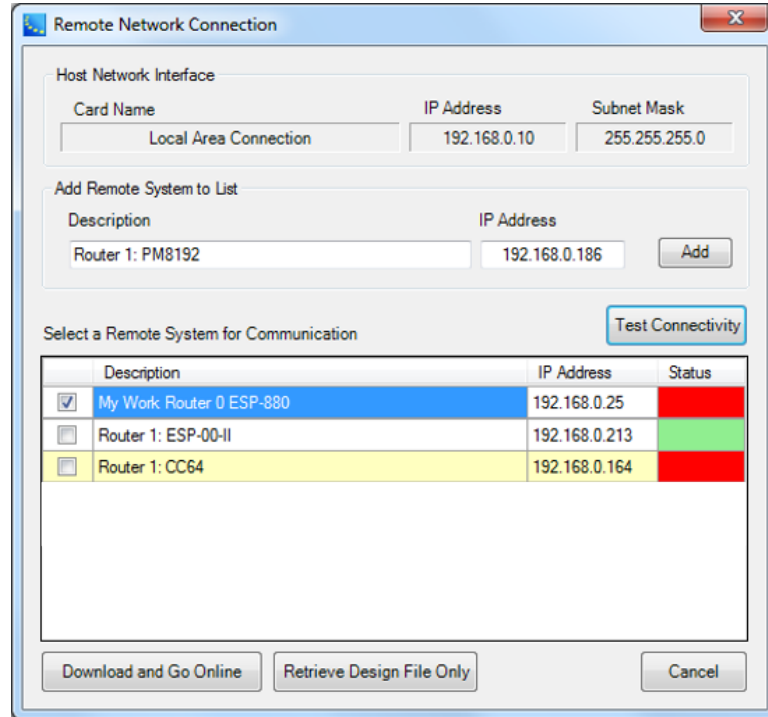

Once a valid connection is made, CSD can communicate with the device(s).

Clicking **Retrieve Design File Only** is equivalent to clicking **Scan** on a local network. Check the box to the left of the desired device. All of the devices that are contained in the Project file of the checked device will load into Project View. If the devices are physically present on the remote network, they will be shown as such in Project View. If they are not, they will be shown as offline (Grey). Once this is done, normal Upload/Download and other online operations can be performed as they would with local devices.

Clicking **Download and Go Online** will Download all Project Data of the devices loaded into the checked device. This essentially skips the **Retrieve Design File Only** step above. CSD will connect to the checked device, and download the Program File from the device. If any devices are not online, they will be shown with Grey headers.

You can now add devices to the Remote Network Connection Device List and recall remote systems at will.

Remote Network Connection with Design File

If you have a design file for your system, you can send it to selected devices and establish a connection.

Select devices from the list and click **Connect (Send)**. A connection will be made and the Remote Network Connection dialog will change to reflect data in the design file.

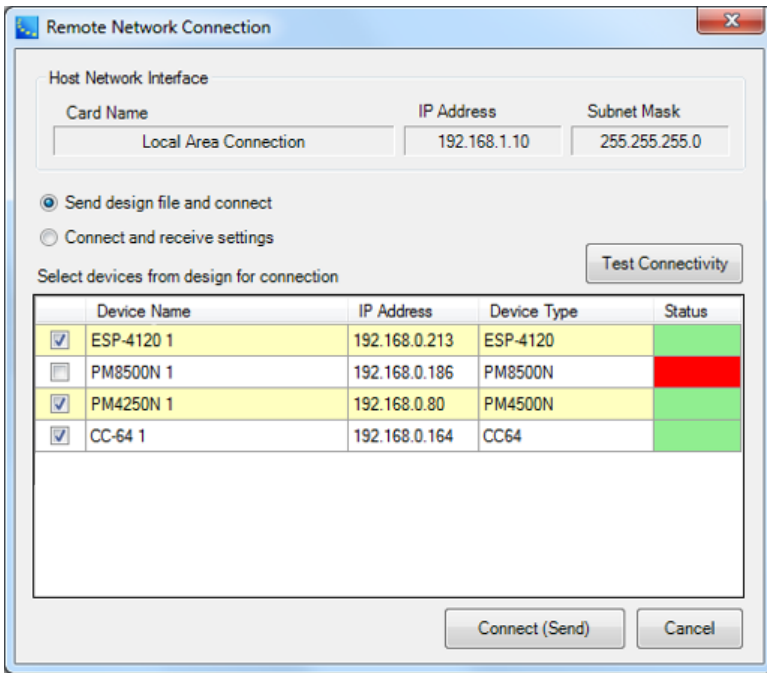

Using VPNs

A Point-to-Point Tunneling Protocol (PPTP) Server is used to create a VPN connection for remote clients. The following instructions show you how to configure a PPTP Server on a TP-Link router. These steps may vary based on the VPN router you choose to use.

TP-LINK is a registered trademark of TP-LINK TECHNOLOGIES CO., LTD.

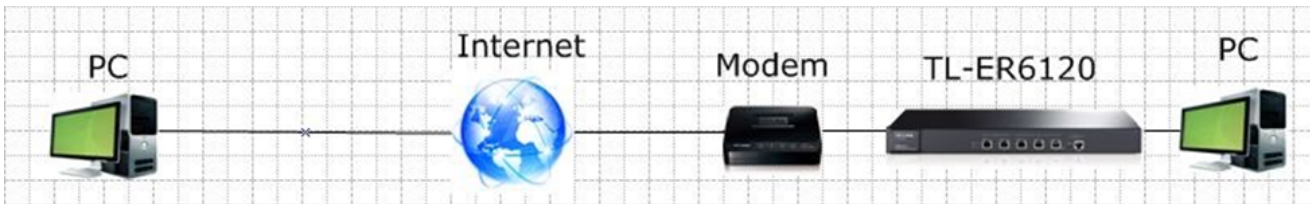

Typical VPN Tunnel Diagram

Four main tasks comprise creating a VPN connection:

- Make sure PCs on both sides can access the Internet**
- Configuring a PPTP Server on a TP-LINK router**
- Configuring a PPTP client on remote PC (Windows 7)**
- Configure ControlSpace Designer Software**

For an example, see **"VPN Site-to-Site Example" on page 540.**

Make sure PCs on both sides can access the Internet

Before setting up a VPN tunnel, you need to ensure that the PCs on both sides are connected to the Internet. Once that is established, use the following steps to properly configure the VPN settings on each side.

NOTE: If the Router is behind a Network Address Translation (NAT) device, Virtual Server or DMZ, they should be configured on the NAT device. Otherwise, the VPN tunnel can't be established.

Configuring a PPTP Server on a TP-LINK router

Step 1:

Access the management web page for the router. The default address of the TP-LINK router is 192.168.0.1. Enter the default username and password for the router.

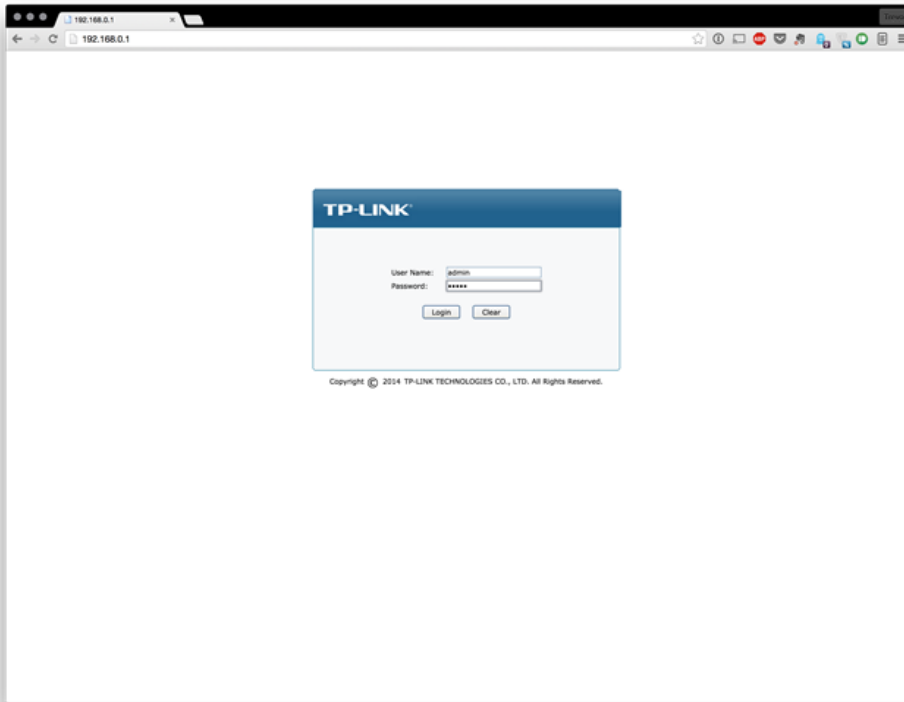

TP-Link Login

From the System Status page, write down the IP Address <WAN IP Address> and LAN IP address range.

The screenshot displays the TP-Link TL-ER6020 System Status page. The interface includes a left-hand navigation menu with options like Network, User Group, Firewall, VPN, and Services. The main content area is titled 'System Status' and contains several sections:

- Device Info:** Firmware Version: 1.0.3 Build 20140604 Rel.64661; Hardware Version: TL-ER6020 v1.0
- System Time:** System Time: 2015-05-25 23:26:08 Monday; Running Time: 3 Min, 17 Sec
- WAN:**

WAN1	Link Up	WAN2	Link Down
Primary Connection:	Dynamic IP	Primary Connection:	Dynamic IP
Status:	Connected	Status:	Connecting...
IP Address:	68.112.228.54	IP Address:	0.0.0.0
Subnet Mask:	255.255.252.0	Subnet Mask:	0.0.0.0
Gateway:	68.112.228.1	Gateway:	0.0.0.0
MAC Address:	30-B5-C2-89-31-15	MAC Address:	30-B5-C2-89-31-16
Secondary Connection:	---	Secondary Connection:	---
Status:	---	Status:	---
IP Address:	---	IP Address:	---
Subnet Mask:	---	Subnet Mask:	---
- LAN/DHCP:**

LAN	192.168.0.1	255.255.255.0	Enabled	30-B5-C2-89-31-14
[Refresh]				
- CPU Usage:** Core0: 2%

Copyright © 2014 TP-LINK TECHNOLOGIES CO., LTD. All Rights Reserved.

TP-Link System Status page

Step 2:

Select **VPN>L2TP/PPTP>IP Address Pool**. Enter the Pool Name, IP Address Range, and then click **Add**.

NOTE: The IP Address pool must be a different range than the LAN IP address range.

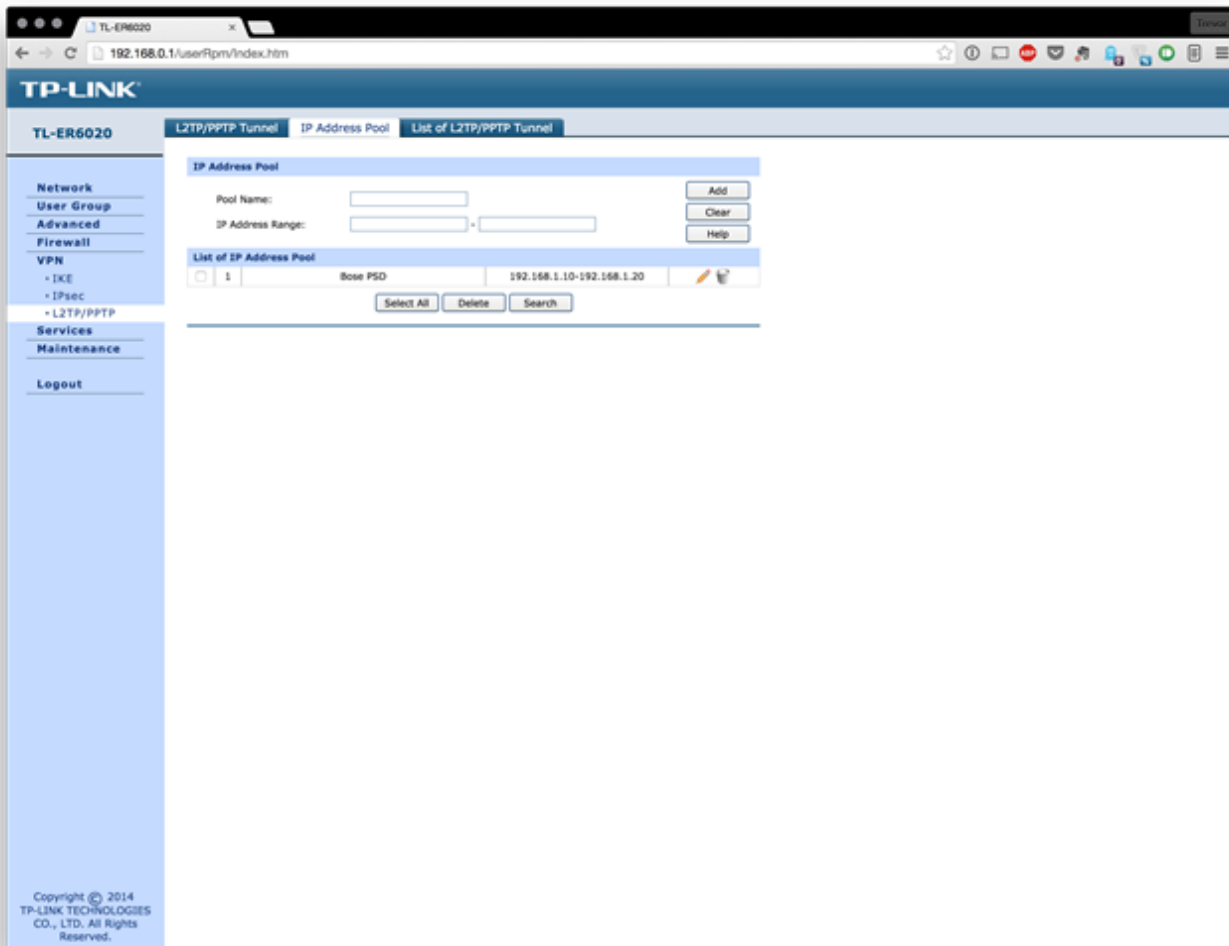

Step 3:

Select **L2TP/PPTP Tunnel**. Configure the following settings:

- Protocol: PPTP
- Mode: Server
- Account Name: <account name>
- Password: <password>
- Tunnel: Client-to-LAN
- Max Connections: 1-10 (We used 5 in this example)
- Encryption: Enable
- IP Address Pool: Select the group added in Step 2.
- Status: Activate

Click **Add**.

Click **Save**.

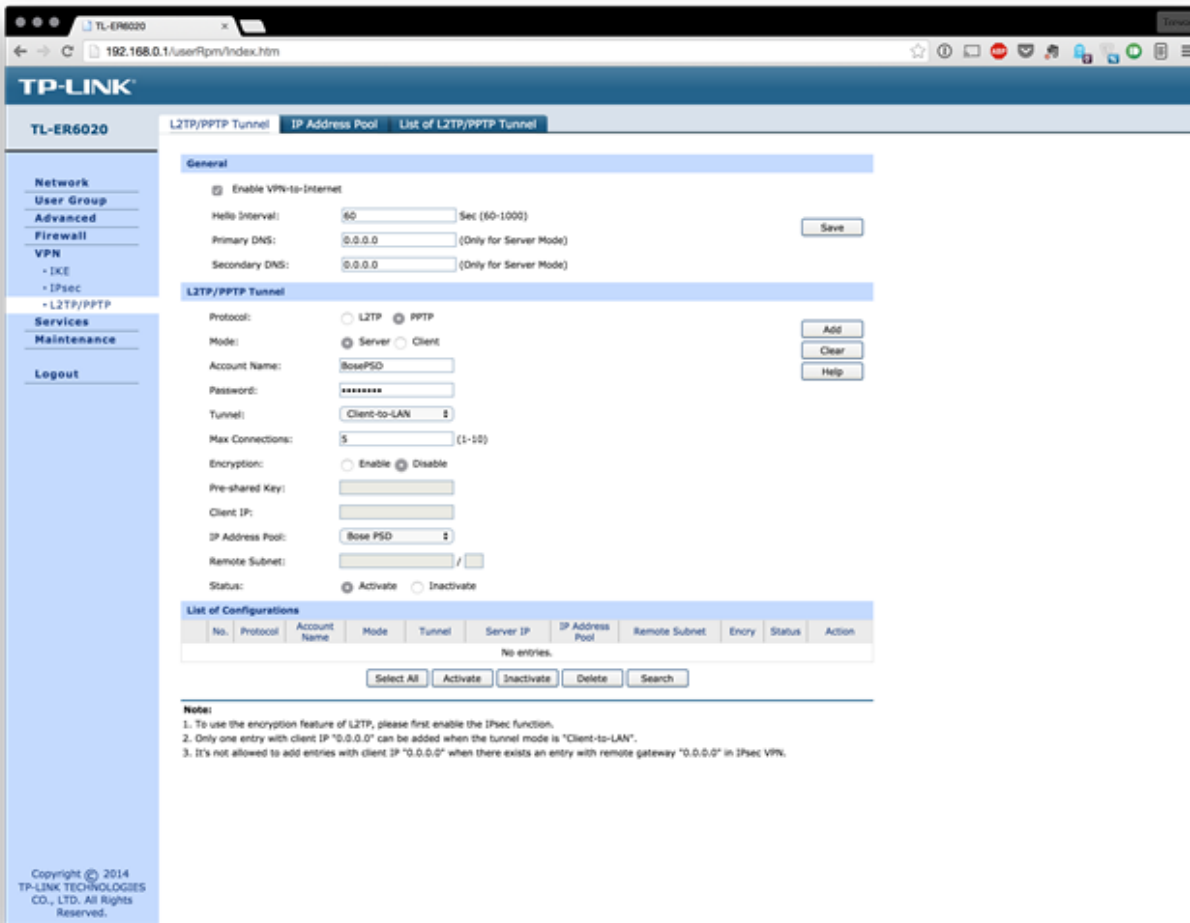

Configuring the L2TP/PPTP tunnel

Configuring a PPTP client on remote PC (Windows 7)

NOTE: For a remote PC to connect to a PPTP server, it can use the Windows built-in PPTP software or a third-party PPTP software.

Step 1:

Select **Start>Control Panel>Network and Internet>Network and Sharing Center**.

Step 2:

Click **Set up a new connection or network**.

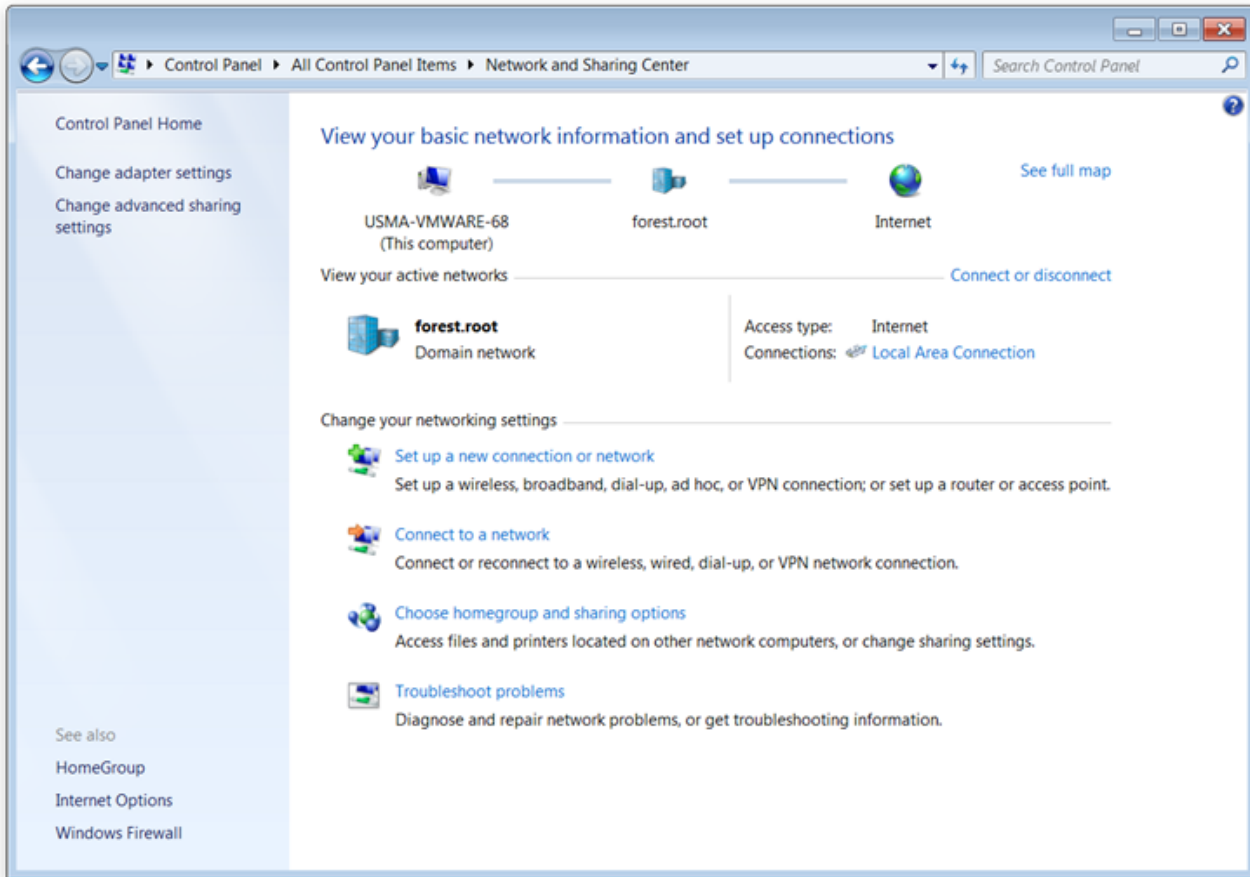

Windows Network and Sharing Center

Step 3:

Choose **Connect to a workplace**, and click **Next**.

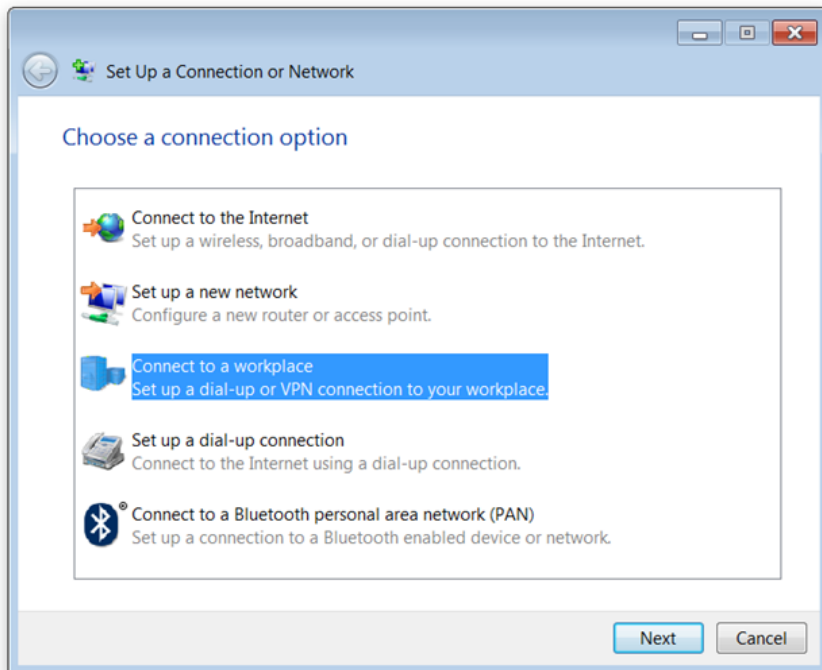

Choosing a connection option

Step 4:

Select **Use my Internet connection (VPN)**.

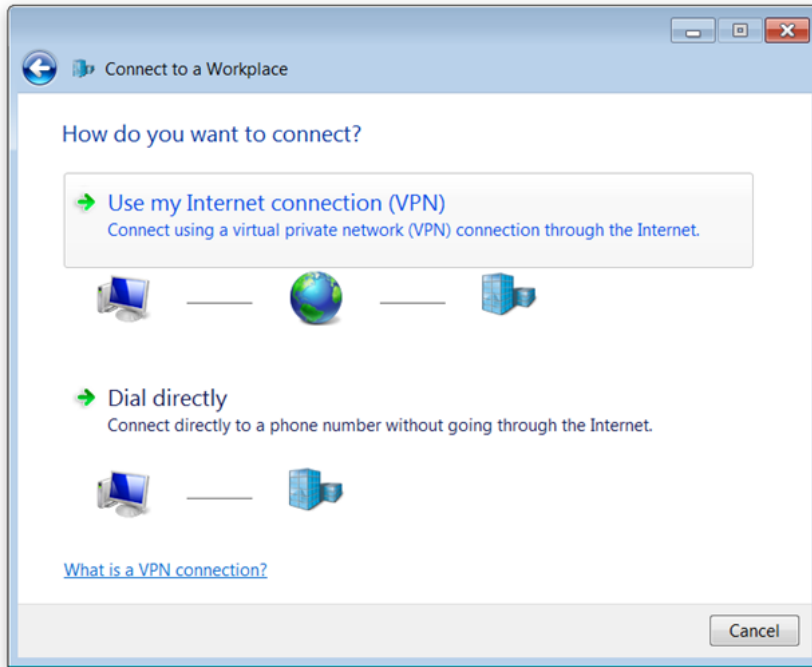

Choosing a type of connection

Step 5:

Enter the following information:

- Internet Address: <WAN IP Address> (See Step 1 - Configuring a PPTP Server on TP-LINK router)
- Destination Name: <Name of Site>

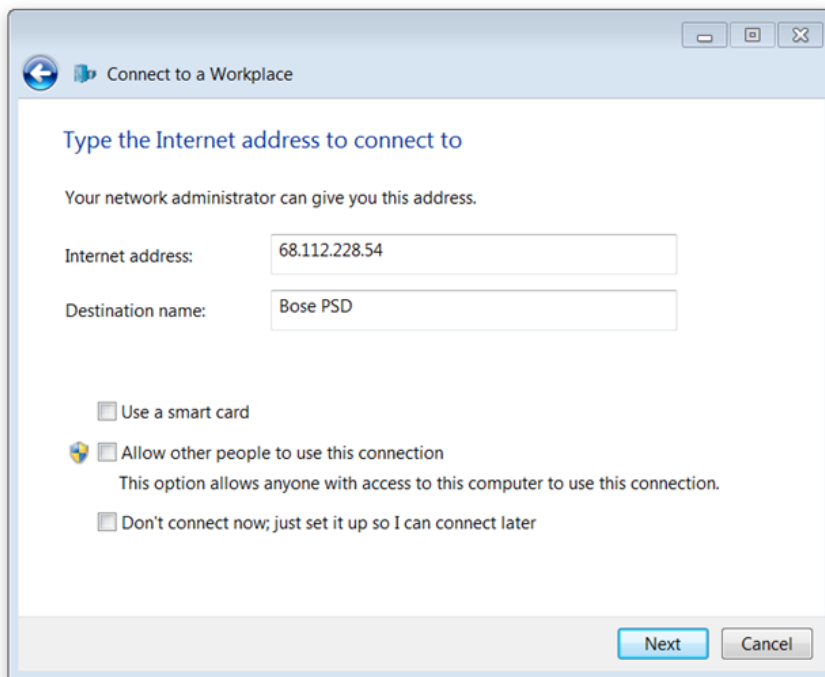

Entering the Internet address and destination

Step 6:

Enter User name and Password and click **Connect**.

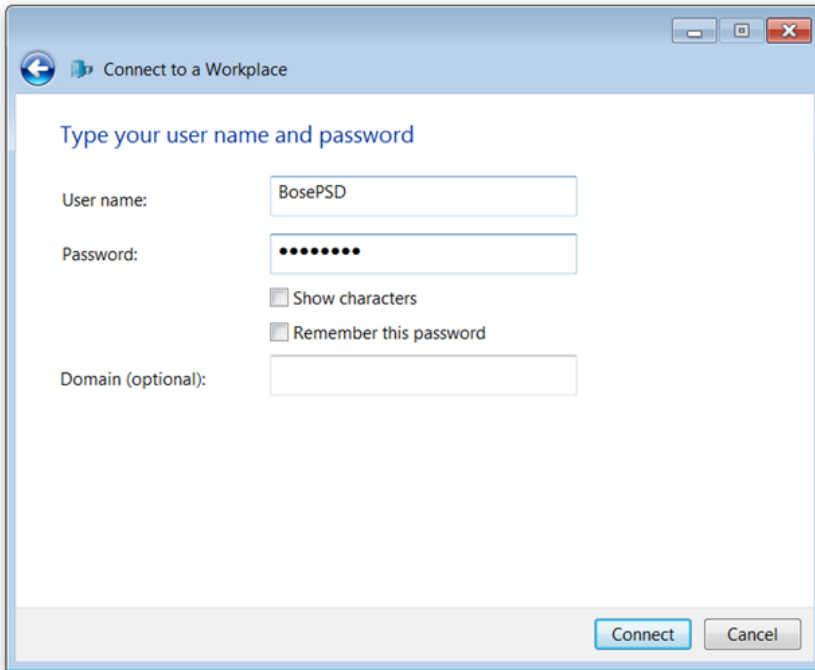

Connect to a Workplace

Type your user name and password

User name: BosePSD

Password: ●●●●●●

Show characters

Remember this password

Domain (optional):

Connect Cancel

Step 7:

The VPN Connection is created and should now connect to the remote system

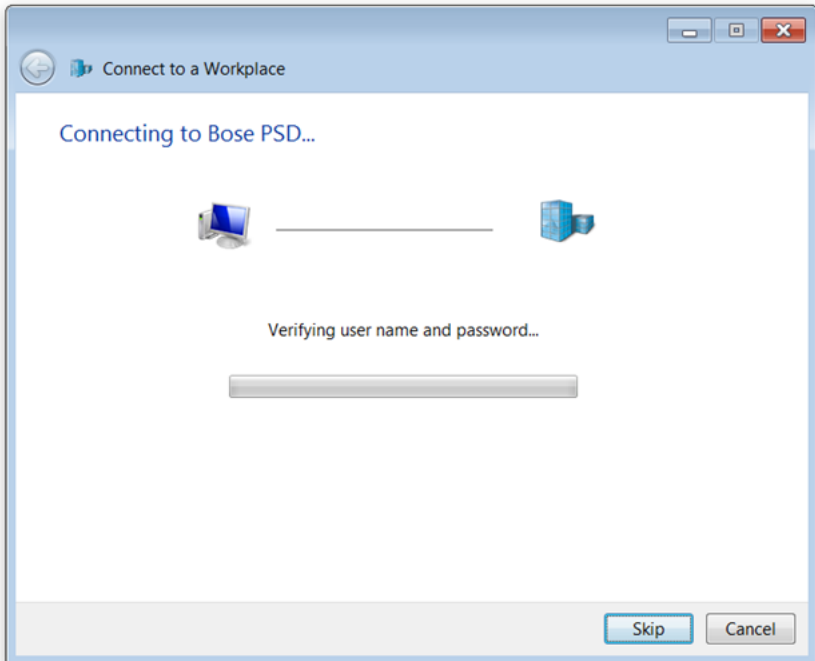

Connect to a Workplace

Connecting to Bose PSD...

Verifying user name and password...

Skip Cancel

Step 8:

Go to **Network and Sharing Center**>**Change adapter settings**.

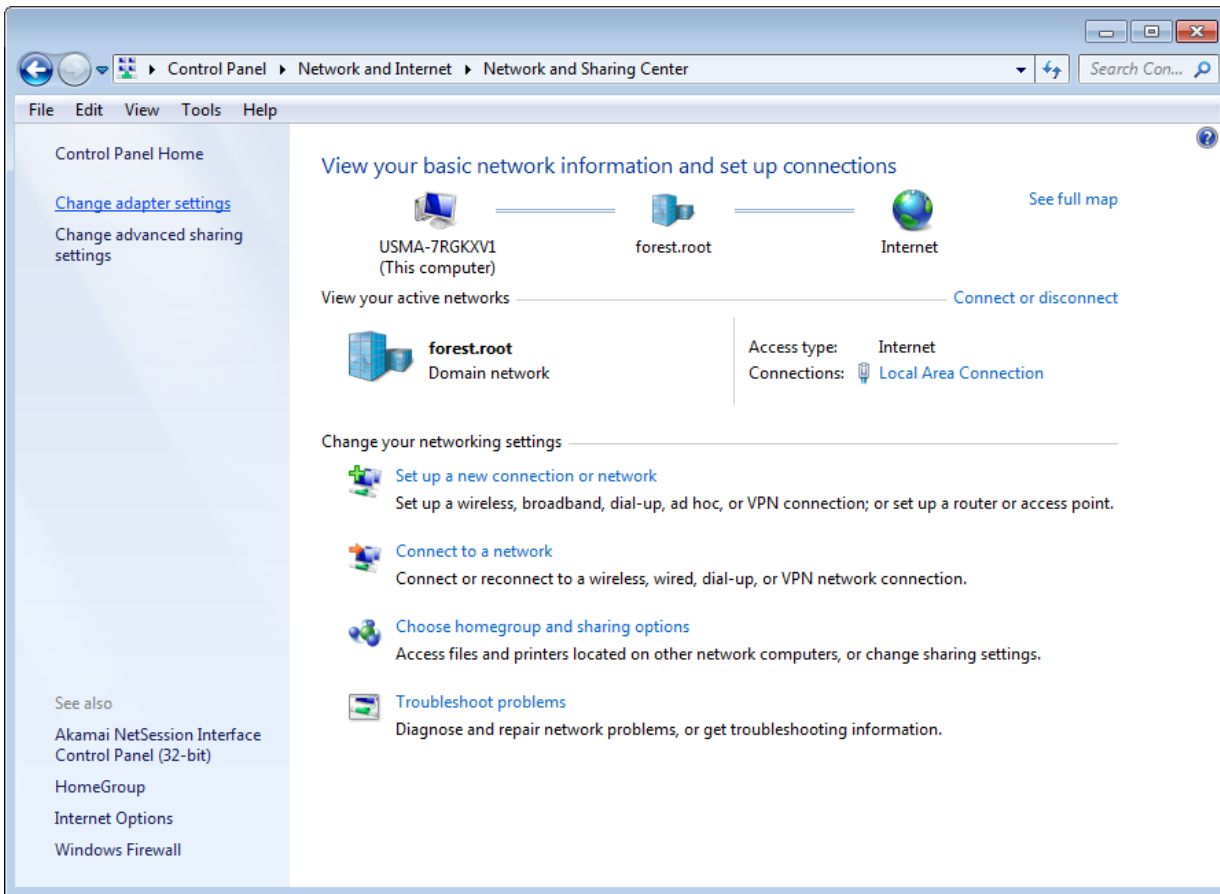

Step 9:

Double-click on **Bose PSD** to open the login panel.

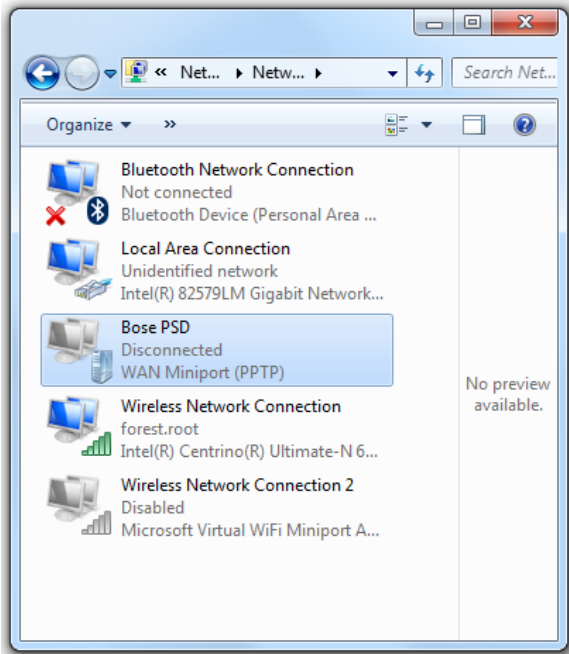

Selecting Bose PSD VPN

Step 10:

Enter User name and Password and then click **Connect**.

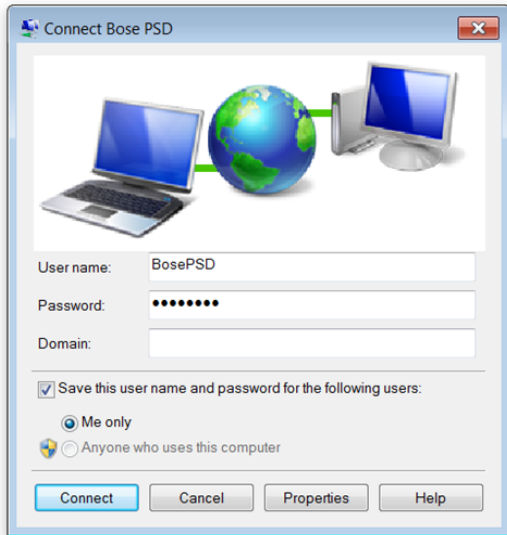

Connecting to VPN

Configure ControlSpace Designer Software

Step 1:

Navigate to **System>Enable Remote Connection**.

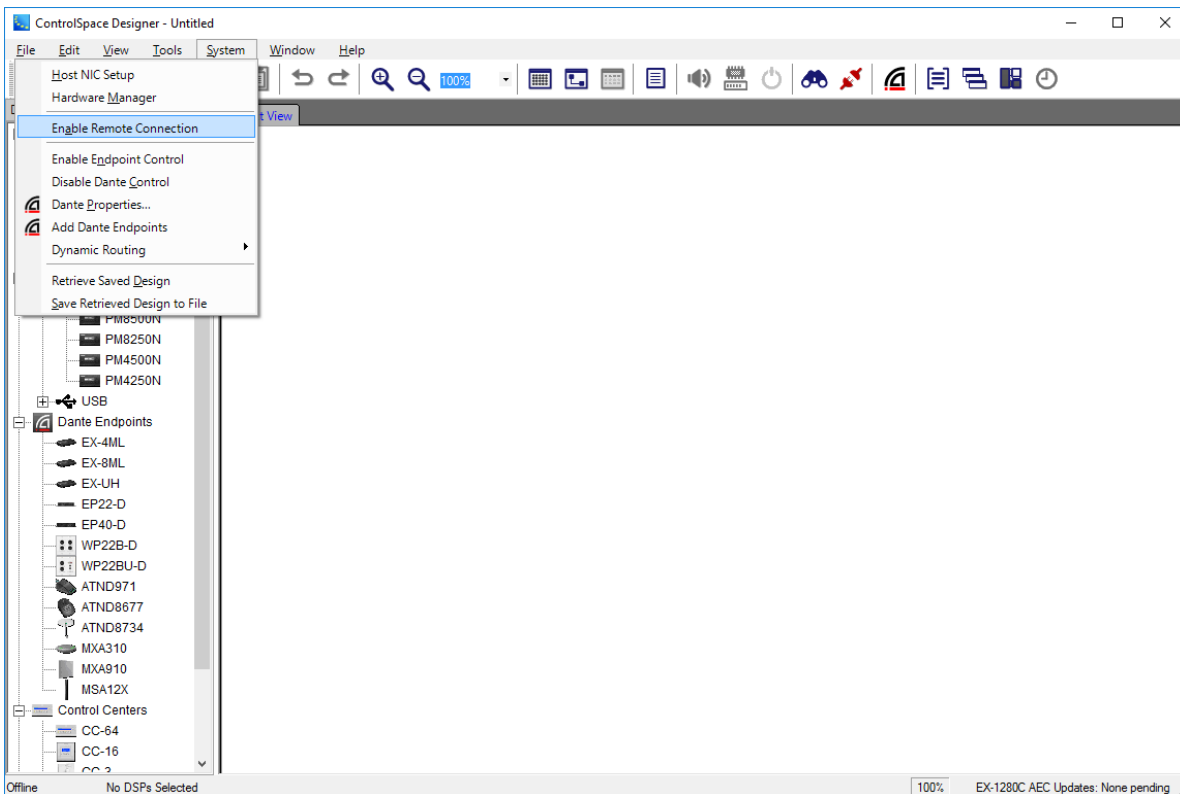

Enabling a remote connection

Step 2:

Navigate to **System>Remote Network Connection**.

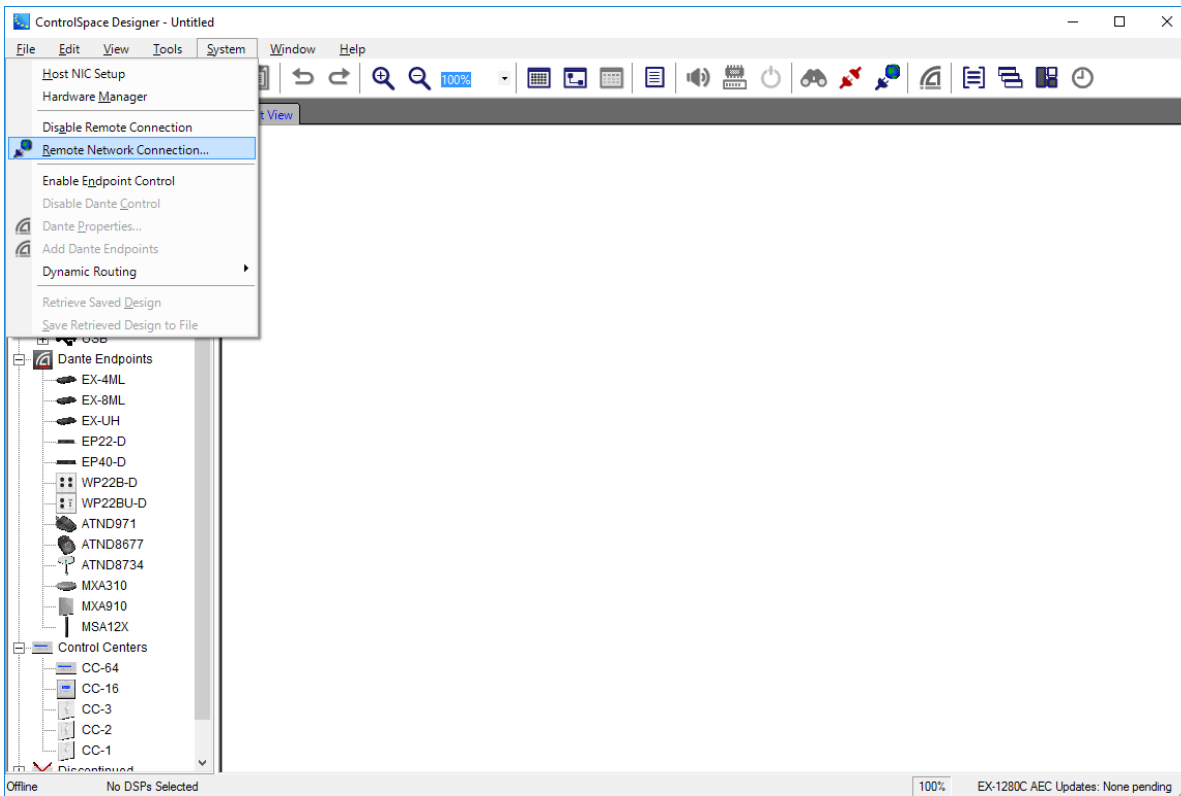

Step 3:

Enter the following Information:

- Description: <Description of Site>
- IP Address: <IP Address of sound processor or PM that contains the CSD file>

Click **Add**.

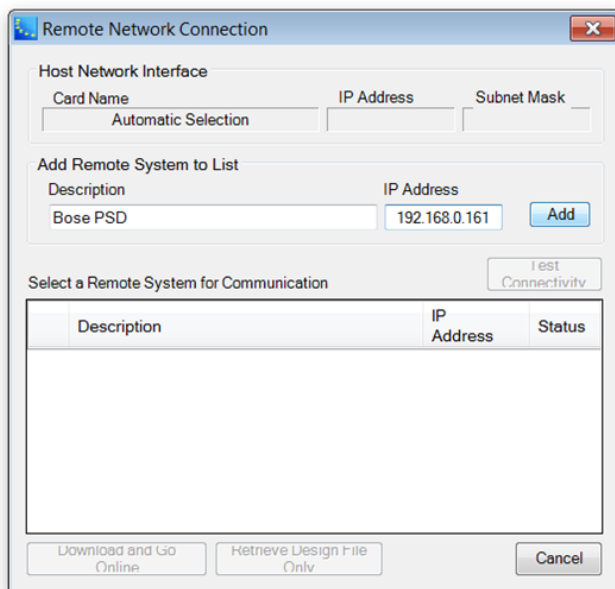

Adding Remote Connection Information

Step 4:

Click the check box next to the remote system **Description** name, and then click **Test Connectivity**.

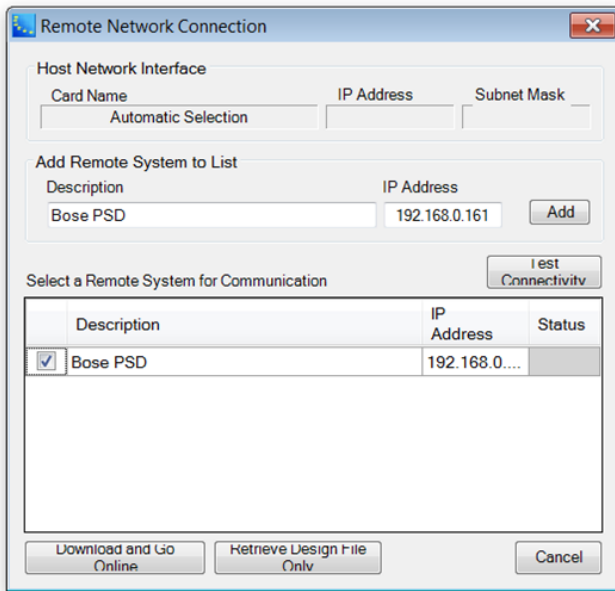

Starting Connectivity Test

Step 5:

Verify the settings. If the everything is setup properly the Status indicator will be Green.

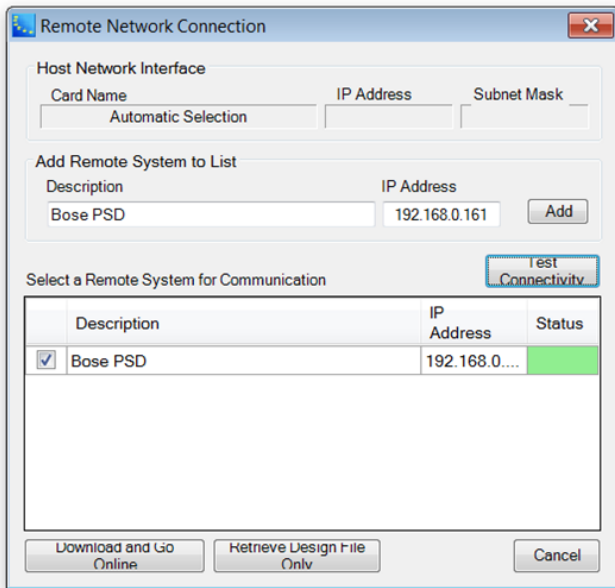

Connectivity Test Results

Step 6:

Click **Download and Go Online** or **Retrieve Design File Only** based on what you want to do. Now you can use ControlSpace Designer like you are connected locally.

VPN Site-to-Site Example

This VPN Site to Site example describes how to configure the following hardware:

- Two NETGEAR® FVS318G ProSAFE® VPN Firewall Routers
- One NETGEAR ProSAFE Switch

- At least two ControlSpace[®] networkable devices (PowerMatch[®] amplifier, ESP processor, CC-64 controller)
- Two PCs

NETGEAR, the NETGEAR logo, and ProSAFE are trademarks of NETGEAR, Inc. Any other trademarks in this document are for reference purposes only. ©2015 NETGEAR, Inc.

Configure Router 1

1. Connect a PC to Router 1. Set the PC IP address to the 192.168.1.n scheme.

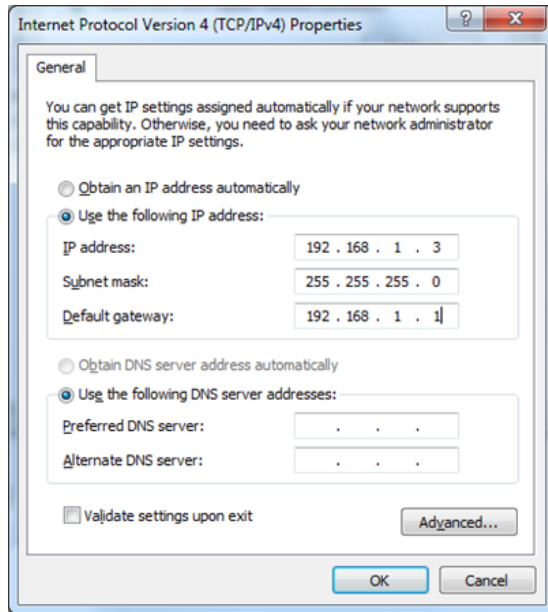

PC Properties for Router 1

2. Launch the Web Browser and enter IP of Router 1 (192.168.1.1 in this example).

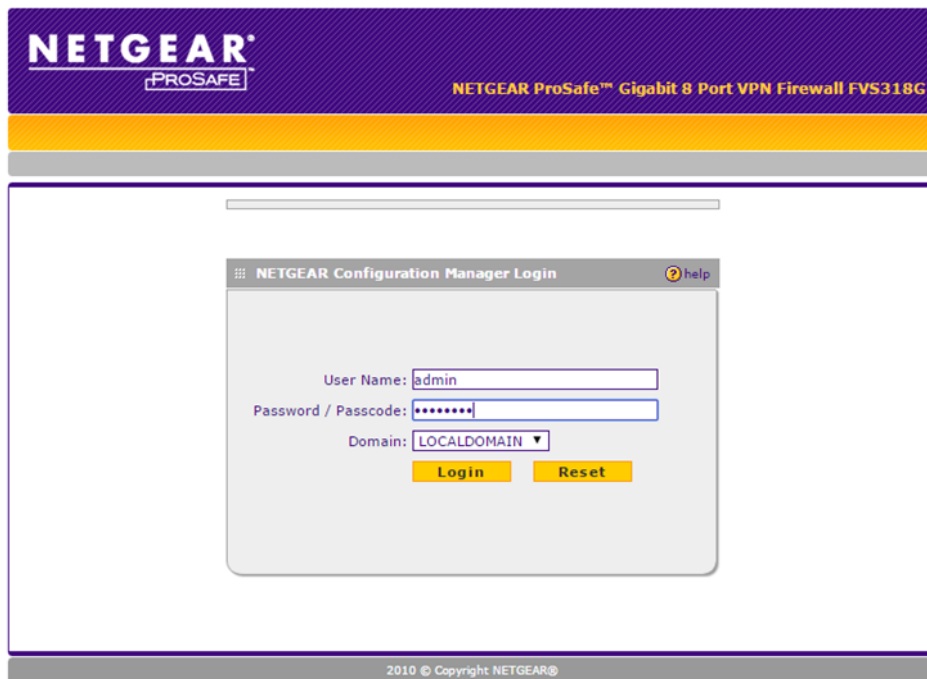

NETGEAR Login for Router 1

3. Enter User Name: admin and Password: <password to log in>.

4. In the router, select the VPN Wizard.

NETGEAR
PROSAFE

NETGEAR ProSafe™ Gigabit 8 Port VPN Firewall FVS318G

| Network Configuration | Security | **VPN** | Users | Administration | Monitoring | Web Support | Logout |

:: Policies :: **VPN Wizard** :: Certificates :: Mode Config :: VPN Client :: Connection Status ::

VPN Wizard VPN Wizard Default Values

About VPN Wizard help

The Wizard sets most parameters to defaults as proposed by the VPN Consortium (VPNC), and assumes a pre-shared key, which greatly simplifies setup. After creating the policies through the VPN Wizard, you can always update the parameters through the [Policies](#) menu.

This VPN tunnel will connect to the following peers:

Gateway VPN Client

Connection Name and Remote IP Type help

What is the new Connection Name?

What is the pre-shared key? (Key Length 8 - 49 Char)

End Point Information help

What is the Remote WAN's IP Address or Internet Name?

What is the Local WAN's IP Address or Internet Name?

Secure Connection Remote Accessibility help

What is the remote LAN IP Address? . . .

What is the remote LAN Subnet Mask? . . .

Apply **Reset**

2010 © Copyright NETGEAR®

VPN Wizard for Router 1

- a. Set VPN tunnel to connect to the following peers: Gateway.
- b. Enter a connection name and Remote IP Type pre-shared key of your choosing.
- c. Enter End Point Information:
Remote WAN IP Address: 192.168.10.11
Local WAN IP Address: 192.168.10.10
- d. Enter Secure Connection Remote Accessibility Information:
Remote LAN IP Address: 192.168.0.1
Remote LAN Subnet Mask: 255.255.255.0
- e. Click **Apply**.

Configure Router 2

1. Connect a PC to Router 2. Set the PC IP address to the 192.168.0.n scheme.

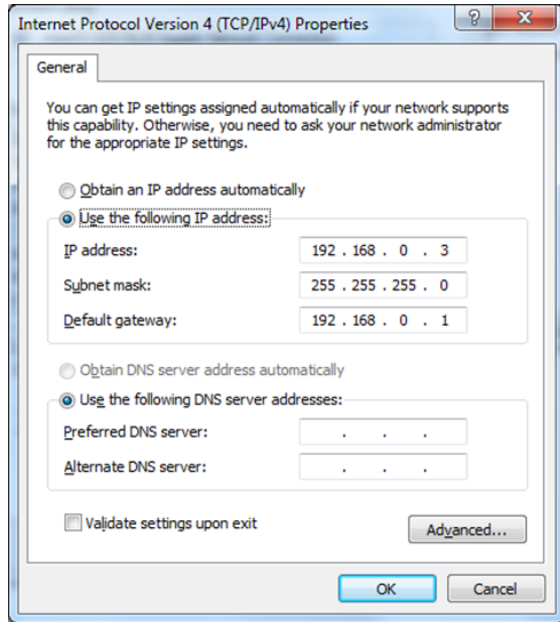

PC Properties for Router 2

2. Launch Web Browser and enter IP of Router 1 (192.168.0.1 in this example).
3. Enter User Name: admin and Password: <password to log in>.

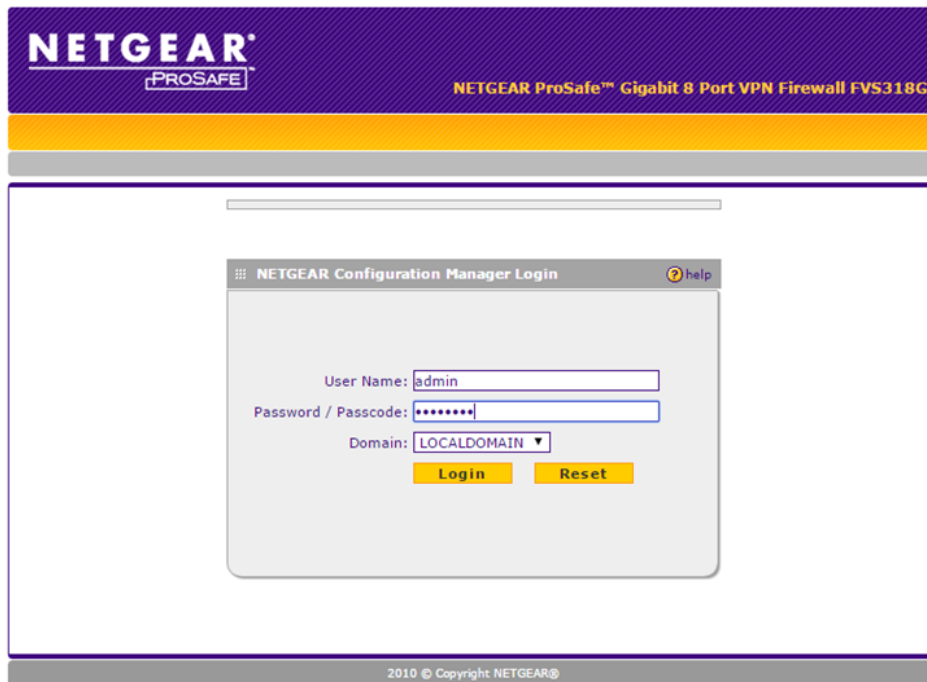

NETGEAR Login for Router 2

4. In the router, select VPN Wizard.

NETGEAR
PROSAFE

NETGEAR ProSafe™ Gigabit 8 Port VPN Firewall FVS318G

Network Configuration | Security | VPN | Users | Administration | Monitoring | Web Support | Logout

Polices :: VPN Wizard :: Certificates :: Mode Config :: VPN Client :: Connection Status

VPN Wizard VPN Wizard Default Values

About VPN Wizard help

The Wizard sets most parameters to defaults as proposed by the VPN Consortium (VPNC), and assumes a pre-shared key, which greatly simplifies setup. After creating the policies through the VPN Wizard, you can always update the parameters through the [Policies](#) menu.

This VPN tunnel will connect to the following peers:

Gateway VPN Client

Connection Name and Remote IP Type help

What is the new Connection Name? SiteToSite

What is the pre-shared key? SiteToSiteKey (Key Length 8 - 49 Char)

End Point Information help

What is the Remote WAN's IP Address or Internet Name? 192.168.10.10

What is the Local WAN's IP Address or Internet Name? 192.168.10.11

Secure Connection Remote Accessibility help

What is the remote LAN IP Address? 192 . 168 . 1 . 1

What is the remote LAN Subnet Mask? 255 . 255 . 255 . 0

Apply **Reset**

2010 © Copyright NETGEAR®

VPN Wizard for Router 2

- Set VPN tunnel to connect to the following peers: Gateway.
- Enter a connection name and Remote IP Type pre-shared key of your choosing.
- Enter End Point Information:
Remote WAN IP Address: 192.168.10.10
Local WAN IP Address: 192.168.10.11
- Enter Secure Connection Remote Accessibility Information:
Remote LAN IP Address: 192.168.1.1
Remote LAN Subnet Mask: 255.255.255.0
- Click **Apply**.

Connect WAN ports of Router 1 and 2 to the NETGEAR switch to simulate WAN

Connect ControlSpace Device(s) to each Router which is pre-configured with IP addresses that correspond to each Router.

For example:

- The devices on Router 1 will follow the 192.168.1.n IP scheme
- The devices on Router 2 will follow the 192.168.0.n IP scheme

Confirm that the PC on Router 1 can communicate with devices on Router 2

1. Reconnect PC to Router 1, Set PC NIC IPv4 to 192.168.1.1 / 255.255.255.0.
2. Log into Router 1 192.168.1.1:
 - a. Select VPN.
 - b. Select Connection Status.
 - c. Click **Connect**. Confirm that the connection is established.
3. While connected to Router 1, perform the following ping tests via Windows command console: (Turn off PC's Wi-Fi NIC).
 - a. Enter ping followed by the corresponding IP address of the LAN, WAN, and Gateway IP for each Router, for example:

C:\>ping 192.168.10.11 (Remote WAN)

Pinging 192.168.10.11 with 32 bytes of data:

Reply from 192.168.10.11: bytes=32 time=5ms TTL=63

Reply from 192.168.10.11: bytes=32 time=4ms TTL=63

Reply from 192.168.10.11: bytes=32 time=4ms TTL=63

Reply from 192.168.10.11: bytes=32 time=4ms TTL=63

Ping statistics for 192.168.10.11:

Packets: Sent = 4, Received = 4, Lost = 0 (0% loss),

Approximate round trip times in milliseconds:

Minimum = 4ms, Maximum = 5ms, Average = 4ms

C:\>ping 192.168.10.10 (Local WAN)

Pinging 192.168.10.10 with 32 bytes of data:

Reply from 192.168.10.10: bytes=32 time=1ms TTL=64

Reply from 192.168.10.10: bytes=32 time=1ms TTL=64

Reply from 192.168.10.10: bytes=32 time=1ms TTL=64

Reply from 192.168.10.10: bytes=32 time=1ms TTL=64

Ping statistics for 192.168.10.10:

Packets: Sent = 4, Received = 4, Lost = 0 (0% loss),

Approximate round trip times in milliseconds:

Minimum = 1ms, Maximum = 1ms, Average = 1ms

C:\>ping 192.168.1.1 (Local LAN - Router 1 Gateway)

Pinging 192.168.1.1 with 32 bytes of data:

Reply from 192.168.1.1: bytes=32 time=2ms TTL=64

Reply from 192.168.1.1: bytes=32 time=2ms TTL=64

Reply from 192.168.1.1: bytes=32 time=1ms TTL=64

Reply from 192.168.1.1: bytes=32 time=1ms TTL=64

Ping statistics for 192.168.1.1:

Packets: Sent = 4, Received = 4, Lost = 0 (0% loss),
Approximate round trip times in milliseconds:
Minimum = 1ms, Maximum = 2ms, Average = 1ms

C:\>ping 192.168.0.1 (Remote LAN - Router 2 Gateway)

Pinging 192.168.0.1 with 32 bytes of data:
Reply from 192.168.0.1: bytes=32 time=8ms TTL=63
Reply from 192.168.0.1: bytes=32 time=7ms TTL=63
Reply from 192.168.0.1: bytes=32 time=7ms TTL=63
Reply from 192.168.0.1: bytes=32 time=7ms TTL=63
Ping statistics for 192.168.0.1:
Packets: Sent = 4, Received = 4, Lost = 0 (0% loss),
Approximate round trip times in milliseconds:
Minimum = 7ms, Maximum = 8ms, Average = 7ms

- b. Enter ping followed by the corresponding IP address of the ControlSpace devices connected to Router 2:

C:\>ping 192.168.0.161 (CS device attached to Router 2)

Pinging 192.168.0.161 with 32 bytes of data:
Reply from 192.168.0.161: bytes=32 time=9ms TTL=62
Reply from 192.168.0.161: bytes=32 time=8ms TTL=62
Reply from 192.168.0.161: bytes=32 time=8ms TTL=62
Reply from 192.168.0.161: bytes=32 time=8ms TTL=62
Reply from 192.168.0.161: bytes=32 time=8ms TTL=62
Ping statistics for 192.168.0.161:
Packets: Sent = 4, Received = 4, Lost = 0 (0% loss),
Approximate round trip times in milliseconds:
Minimum = 8ms, Maximum = 9ms, Average = 8ms

C:\>ping 192.168.1.168 (CS device attached to Router 1)

Pinging 192.168.1.168 with 32 bytes of data:
Reply from 192.168.1.168: bytes=32 time=1ms TTL=64
Reply from 192.168.1.168: bytes=32 time=1ms TTL=64
Reply from 192.168.1.168: bytes=32 time=1ms TTL=64
Reply from 192.168.1.168: bytes=32 time=1ms TTL=64
Ping statistics for 192.168.1.168:
Packets: Sent = 4, Received = 4, Lost = 0 (0% loss),
Approximate round trip times in milliseconds:
Minimum = 1ms, Maximum = 1ms, Average = 1ms

- c. Launch CSD while connected to Router 1, scan for devices attached to Router 1 (192.168.1.n). All CS devices connected to Router 1 should populate Project View.
- d. Within CSD, select New to clear Project View. Change the Project Network Address to 192.168.0.n and scan for CS Devices on Router 2. All CS devices connected to Router 2 should populate Project View.

CobraNet Digital Audio Networks

CobraNet Network Audio

CobraNet network audio expansion cards are available for the ESP-00 II engineered sound processor and the PowerMatch[®] configurable professional power amplifiers. The cards use industry-standard CobraNet technology to transport multiple channels of high quality, uncompressed digital audio in real time across a standard Ethernet network. CobraNet network audio distribution is typically used in systems which require signal processors and amplifiers are in different parts of a large building or complex, or to interlink multiple devices within an equipment rack to reduce analog cabling and connections.

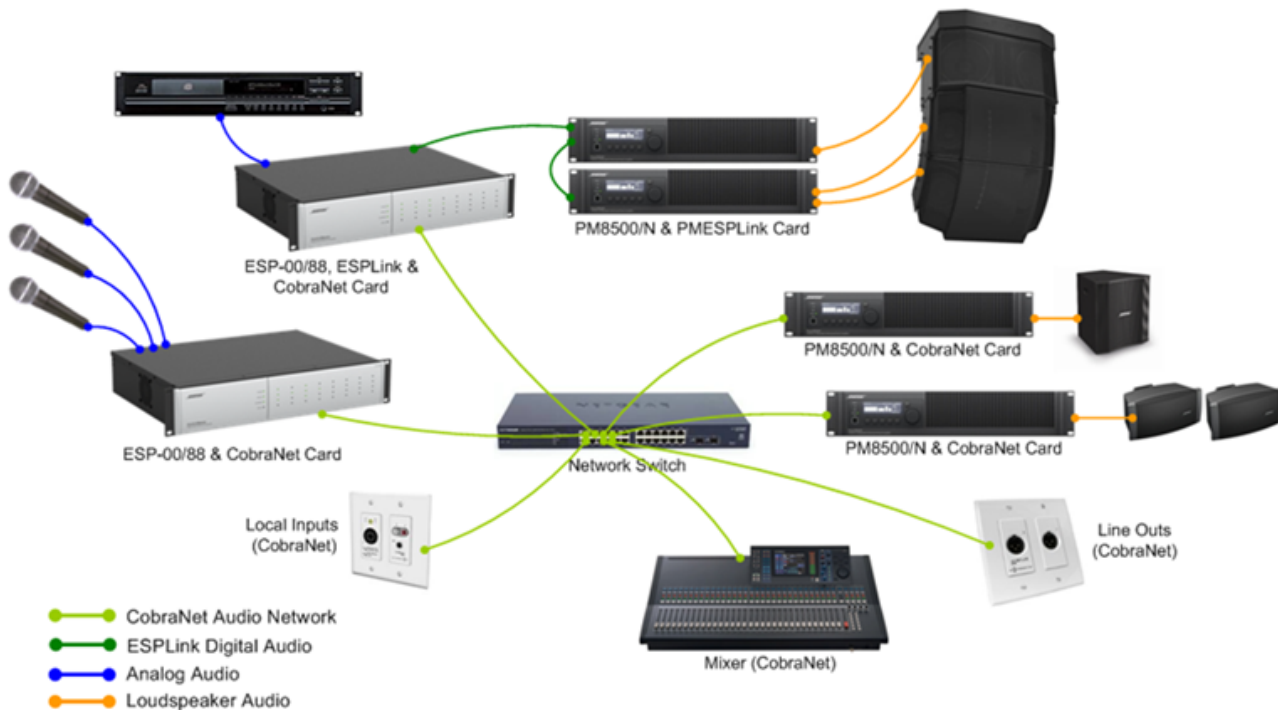

Example system using CobraNet network audio distribution

A CobraNet audio network is built using a standard 100Mbit (Fast Ethernet) or 1000Mbit (Gigabit) Ethernet network and can utilize industry-standard structured network cabling (CAT5E/CAT6), Ethernet switches and other network components.

While systems using less than 8 CobraNet audio "bundles" may use a standard Fast Ethernet router, we recommend that a standard Ethernet switch is used to avoid complications. For Larger systems, and in systems which require quality of service (QoS) management, a managed switch is recommended. The use of repeaters/hubs, however, is not recommended and should be avoided.

When using CobraNet with ControlSpace devices, the CobraNet audio data and the ControlSpace control data must be isolated from each other using physically separate networks as the volume of traffic pro-

duced by CobraNet is incompatible with the 10Mbit control connection found on some ControlSpace devices.

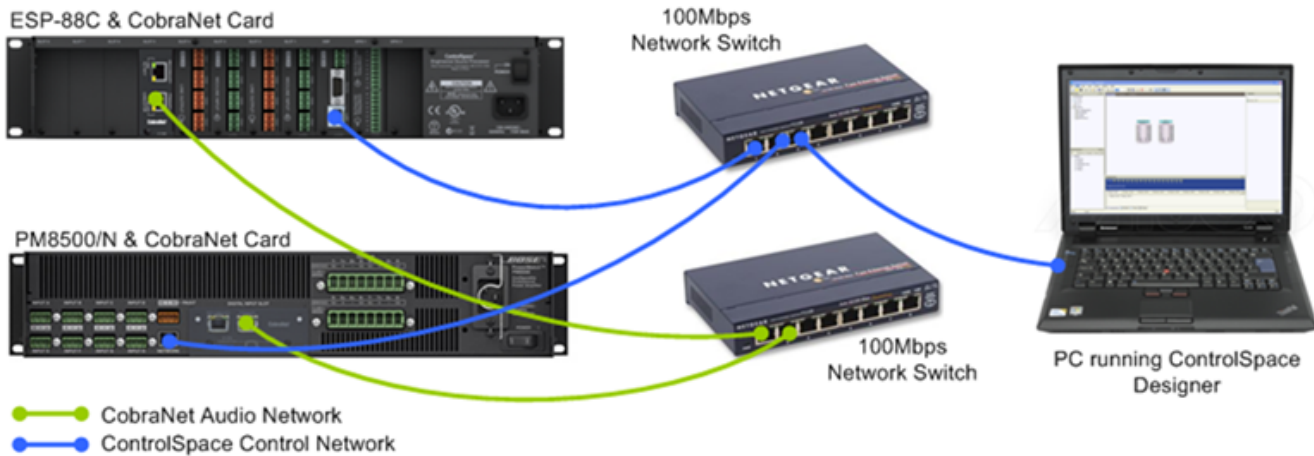

Example implementation of audio and control networks using physically separate networks

If a managed switch will be used in the system, the creation of a separate VLAN for one of the two networks is acceptable. Using a "Smart" or "Layer 2 Managed" Ethernet switch that supports VLANs, it is possible to partition the networks within a single switch as shown below.

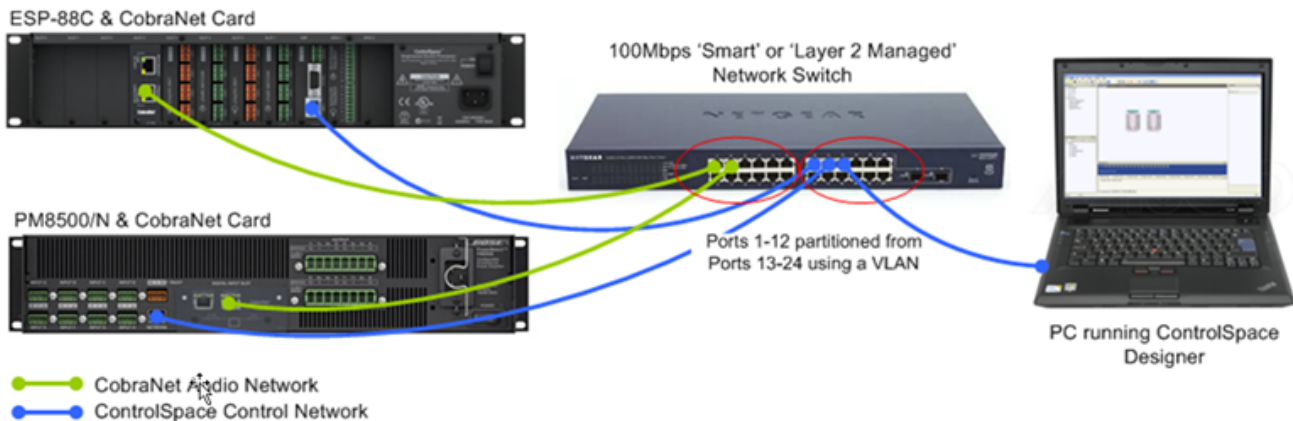

Example implementation of audio and control networks using a VLAN

In order to avoid unwanted audio artifacts and drop-outs the CobraNet network relies on the timely delivery of audio data and therefore has some fairly strict network requirements. Each time a switch is inserted in the transmission path between the sending and receiving device, known as a 'switch-hop', a small amount of propagation delay occurs. In order for this delay to not affect correct operation a maximum of six 'switch-hops' is recommended for 100Mbit networks, (when using the Standard [5.33mS] latency option). Since 1000Mbit network switches are designed to operate at faster speeds their propagation delay has less significance.

Consistent with most computer based Ethernet networks (and the ControlSpace control network), CobraNet networks typically use a 'Star' or 'Star of Stars' layout. In the example shown below a maximum of three switch-hops is required to reach any other device on the network.

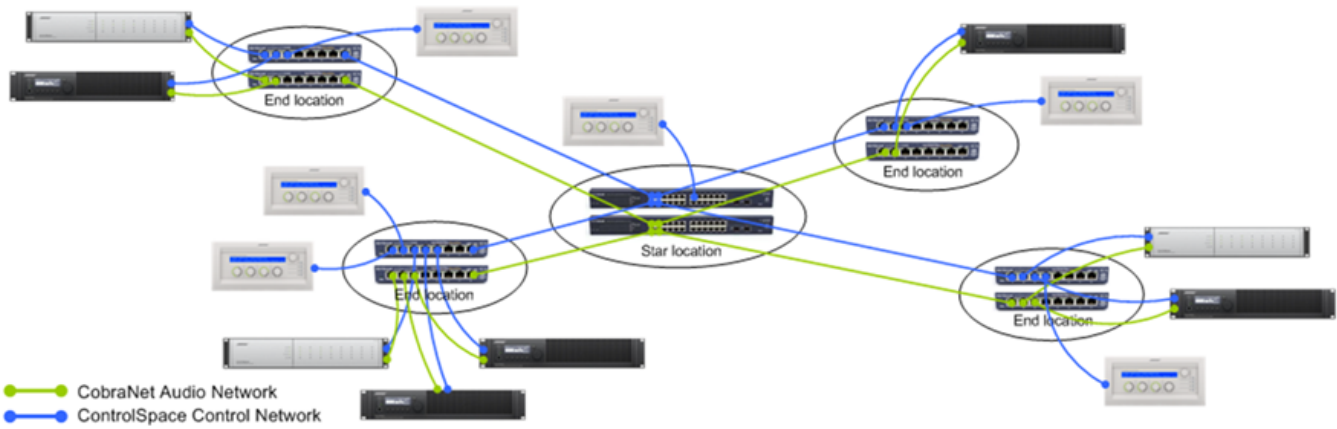

Typical 'Star of Stars' network topology

Each CobraNet network audio interface includes two physical connections, Primary and Secondary, but only use one at any given time. The Secondary port adds redundancy and is used automatically should the Primary connection to the network fail.

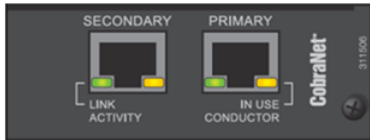

CobraNet Audio Network Card

While the two ports provide redundancy for the connection between the CobraNet card and the network, the resilience of the complete connection between CobraNet devices will depend on the network design. Various techniques and protocols exist to provide automatic backup and redundancy for Ethernet networks. Some of these are shown below:

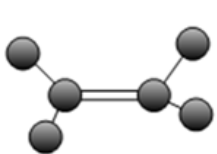

Link aggregation/Trunking

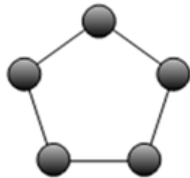

Ring (with Spanning Tree)

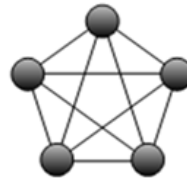

Meshing

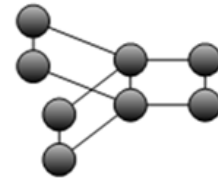

Dual Link (with Spanning Tree)

Redundant network topologies

See [CobraNet Input/Output Card](#) for the ESP-00/00 II.

See [CobraNet® Network Expansion Card](#) for the PM8500/N, PM8250/N, PM4500/N and PM4250/N.

CobraNet® is a trademark of Cirrus Logic, Inc.

CobraNet® Network Audio Routing

Within a CobraNet® network, audio is passed between devices in Bundles; each Bundle can carry up to eight audio channels. Each CobraNet device may be configured as a transmitter, receiver or both. The exact channel count capabilities of the device are somewhat dependent upon the hardware and are typically pre-determined by the manufacturer.

A CobraNet receiver may be connected to only one transmitter which must be on a different device. The CobraNet Bundle assignment is the method by which devices determine how audio data is routed throughout the system. The Bundle address also is used to determine the transmission method for the audio data:

Multicast method: When a transmitting device broadcasts its audio data to the network and may be received by any receiving device.

Unicast method: When the transmitting device broadcasts its audio data to a single receiving device.

The Bundle address given to a transmitting device determines whether the data will be broadcast using the Multicast or Unicast method. Bundle numbers are normally in the range 1-65,279 with 1-255 defined as Multicast and 256-65,279 usually defined as Unicast.



Examples of Unicast and Multicast audio routing.

The type of broadcast method used will directly affect the amount of data being transmitted via the network. While both types can only be sent by a single transmitter, and Unicast Bundles can typically only be received by one receiver, a Multicast Bundle can be received by any number of devices, but adds additional network traffic and should only be used if required. A Multicast Bundle will normally be sent to every port on the network irrespective of whether any receivers are requesting it. Whereas, a Unicast Bundle is only sent to a network port leading to the CobraNet device requesting it. Otherwise, it is not transmitted. Eight bundles on any port (including all the Multicast Bundles on the network) will consume all the available bandwidth on a 100Mbit network and hence a maximum of four Multicast Bundles is generally accepted good design practice.

NOTE: It is possible for Bundles in the Unicast range (256-65,279) to be set to Multi-Unicast (allowing a copy to be received by up to four devices) or Multicast, but these modes are rarely used and are not currently supported within ControlSpace Designer software.

The next two examples show audio routing for typical applications.

Example 1 - audio distribution between multiple processors.

The CobraNet card in ESP-00 II 1 is configured as "16out" and the others as "8in". One Bundle of eight channels passes from ESP-00 II 1 to ESP-00 II 2 and a different Bundle of eight channels passes from ESP-00 II 1 to ESP-00 II 3.

If desired, some or all of the channels in each Bundle can be the same simply by linking the same paths to each CobraNet output module. This is beneficial in that both connections are still from a single transmitter to a single receiver, hence, Unicast Bundles (256-65,279) can be used, preserving network bandwidth.

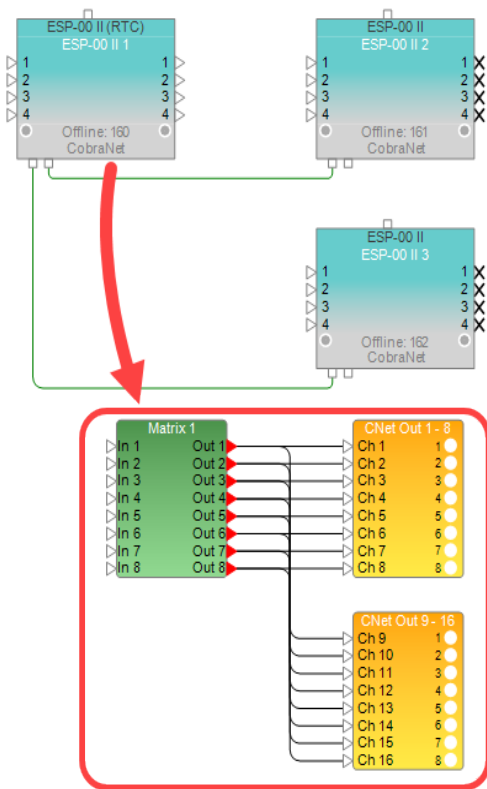

Example 2 - audio distribution to a remote amplifier rack.

In this example, audio is routed from a single ESP-00 II to a remote amplifier rack containing three PowerMatch amplifiers.

With this design, a single Bundle of eight channels is passed from ESP-00 II 1 to all other devices. Since these connections are from a single transmitter, but to multiple receivers, a Multicast Bundle (1-255) would be required.

Being a common scenario, this is a supported out-of-the-box configuration requiring minimal setup.

PowerMatch CobraNet cards come factory set to receive Bundle 100, and with ControlSpace Designer v3.1 or later, the first ESP-00 II CobraNet transmitter in the design will be set automatically to the same Bundle. Hence, once the cards have been physically added and connected, simply uploading the design file to the ESP-00 II is all that is required to establish the link. Routing audio to the CobraNet output module in the ESP-00 II and selecting the Digital source on the amplifiers will then allow audio to pass.

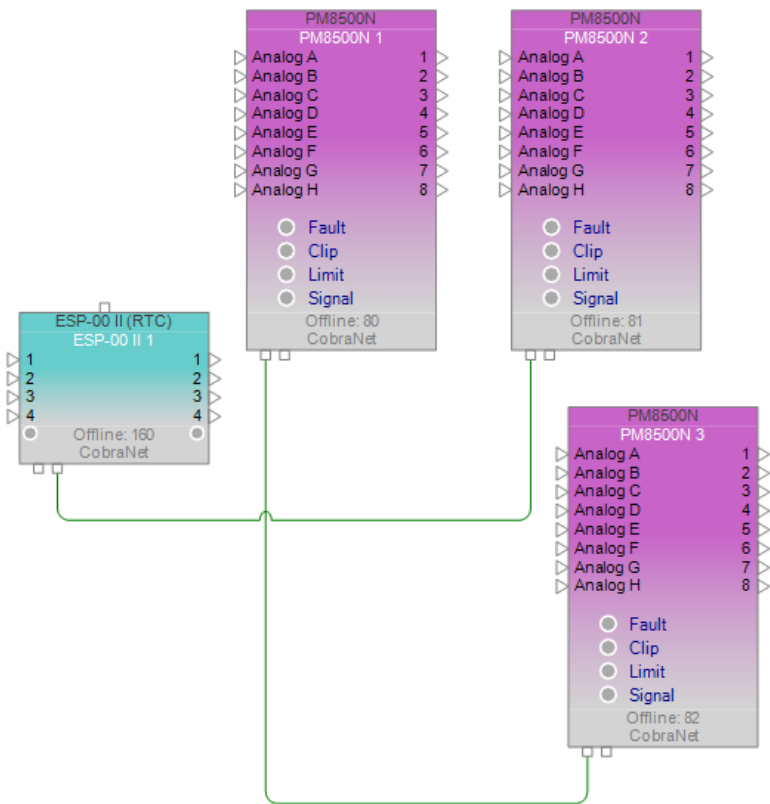

CobraNet Network Status

The most critical component to any networked audio system is that audio is reproduced simultaneously from all system devices. In a situation where a single transmitter is configured for Multicast operation, all receiving devices must synchronously reproduce the audio. If this does not occur the quality of the audio at the listener has the potential to be greatly reduced. To keep all the CobraNet devices synchronized, one node takes on the role of 'Conductor' and generates regular 'Beat' packets that are broadcast to all of the other devices, 'Performers', on the network. Performers use the beat packets to synchronize audio playback and to synchronize their digital clocks locally.

Only one device on the network can be the Conductor, all other devices are performers. If the device identified as the Conductor drops out, after a period of time a new device will step up and fill the role of Conductor to ensure seamless, synchronous operation.

A second important aspect of the network status is that transmitting and receiving devices are configured properly. For example two devices transmitting on the same Bundle number or the presence of a large number of Multicast bundles can lead to network errors. Normally, the settings provided within ControlSpace Designer software will help ensure a proper setup and normal operation. However, it is possible to modify settings using other CobraNet network utilities and create issues with the audio routing, affecting the network status.

Each CobraNet port has two LEDs to indicate the current network status:

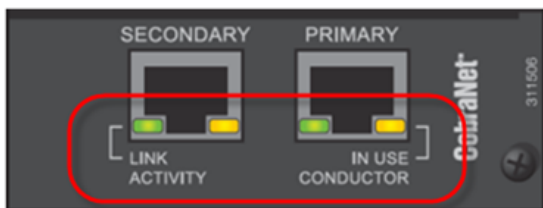

LED Color	Action	Status
GREEN	Solid	Link established with another node or networks switch
GREEN	Blinking	CobraNet activity on the network
ORANGE	Solid	Power applied, node is a Performer (default)
ORANGE	Blinking - single port	Node is the Conductor
ORANGE	Blinking - both ports	Error on the network

CobraNet Examples

CobraNet® Application Examples

CobraNet network audio expansion cards are available for both the ESP-00 engineered sound processors and the PowerMatch® configurable professional power amplifiers. The cards use industry-standard CobraNet technology to transport multiple channels of high quality, uncompressed digital audio in real time across a standard Ethernet network. CobraNet network audio distribution is typically used in systems which require signal processors and amplifiers that are in different parts of a large building or complex, or to interlink multiple devices within an equipment rack to reduce analog cabling and connections.

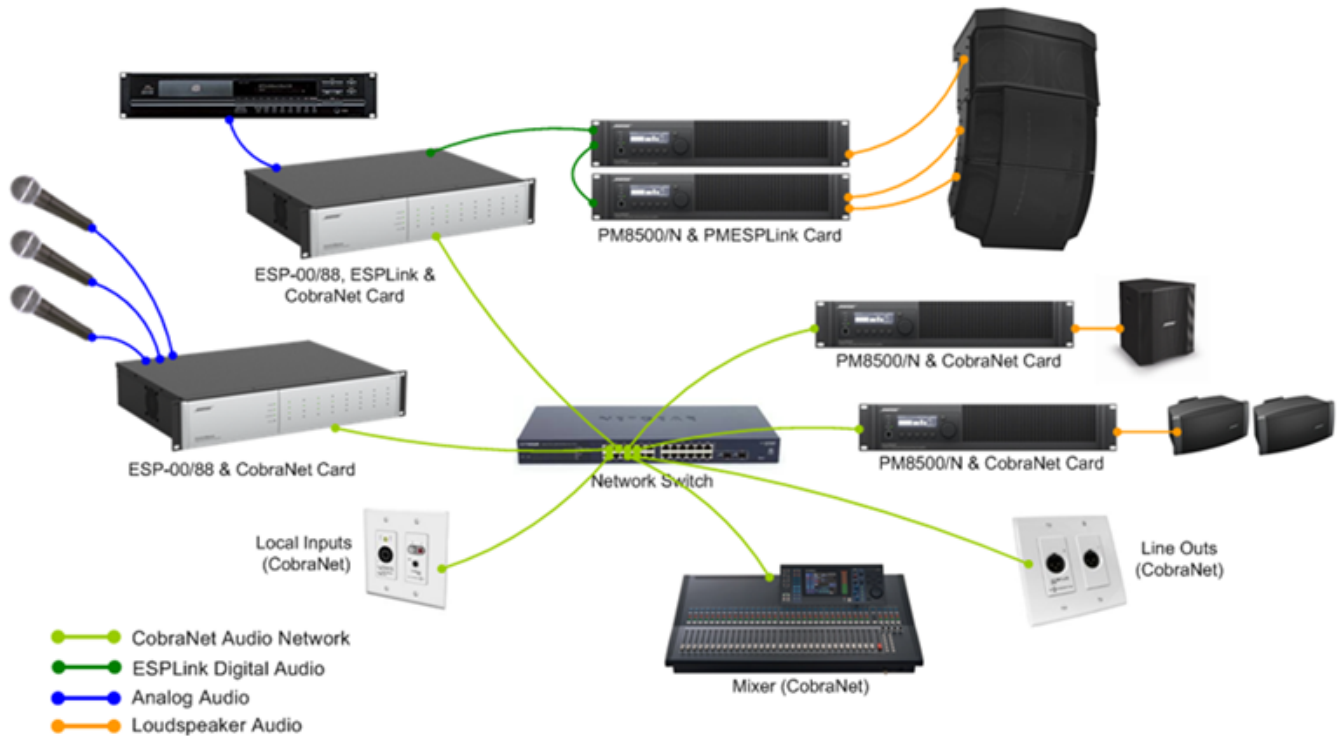

Example system using CobraNet network audio distribution

The following two examples explore several typical system configurations where a CobraNet audio network is used to distribute audio between signal processors and amplifiers.

- **Example #1: ESP-to-ESP Signal Routing**
- **Example #2: ESP-to-Multiple PowerMatch® Amplifiers**

Example #1: ESP-to-ESP Signal Routing

IMPORTANT: CSD screens, buttons, icons, and product references in this topic are from CSD version 4.4.2.

This first example includes two ESP-88s with eight channels of audio passing in each direction between them. This is a common application where the ESPs are physically separated, but act as the primary signal processor for their area. Each ESP provides a number of analog inputs for local sources, while the output section is used for local sound reinforcement. However, there is a need to make all input sources available to both areas, which is accomplished by routing the audio between the units using a CobraNet network.

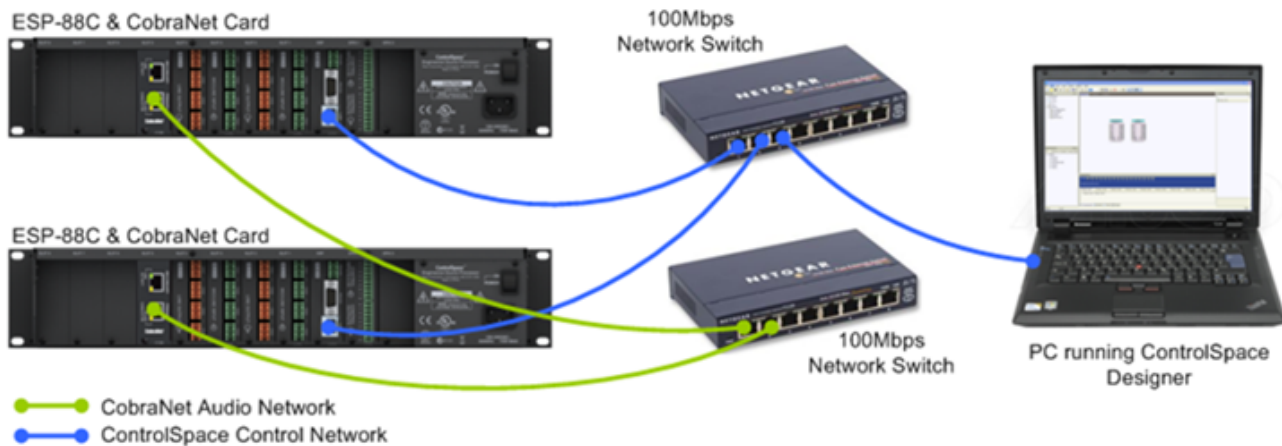

System configuration for ESP to ESP signal routing

NOTE: Before following these steps to configure this example system, it is assumed that a CobraNet card has been correctly installed into each ESP and that the independent networks have been created for CobraNet and the ControlSpace control network.

1. Using ControlSpace Designer v2.321 or later, create a new design file and perform a hardware scan either by choosing the option from the Tools menu or by using the toolbar button, .
2. Assuming that all the network connections and settings are correct the two ESP-88s should be detected, populated with their standard 4x4 cards plus the additional CobraNet expansion card. By default the card will be shown as the '16 in, 16 out' variant unless there is an existing design file in the ESP with the card configured differently.
3. Since this system design only requires the CobraNet cards to have 8 inputs and 8 outputs the card can be configured as the '8 in, 8 out' variant, leaving four routing slots (three physical slots) available for other expansion cards. This can be changed in the ESP Properties window which is accessed by right-clicking on each ESP in Project View and selecting 'Properties'.

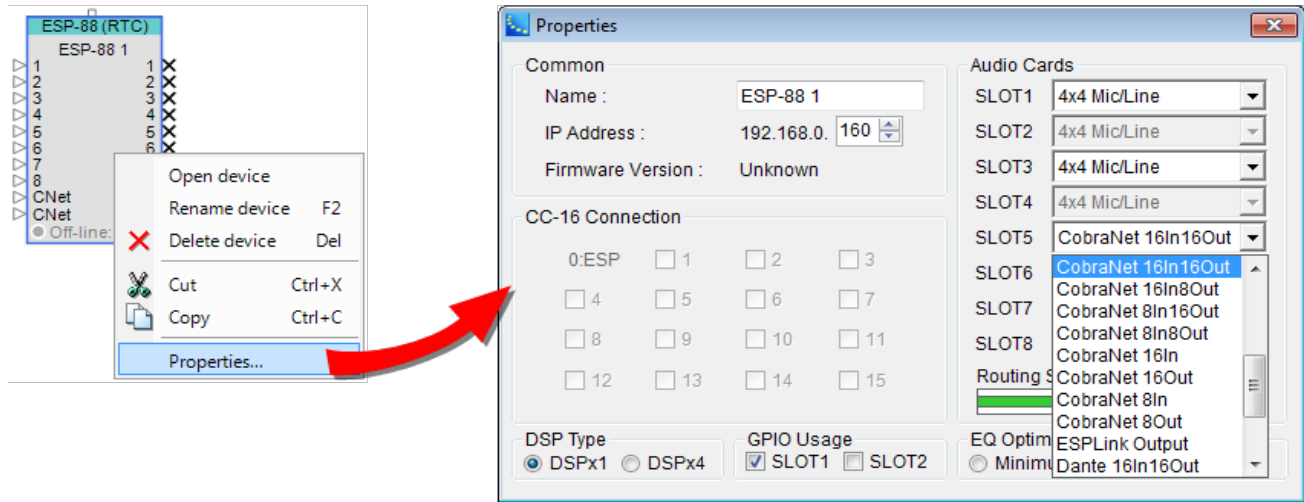

CobraNet configuration within ESP properties

- Once the card variant has been changed it is recommended that the required connections between CobraNet transmitters and receivers are drawn in the Project View. While this has no influence on the actual operation it is a good visual reference of the CobraNet links that will be required.

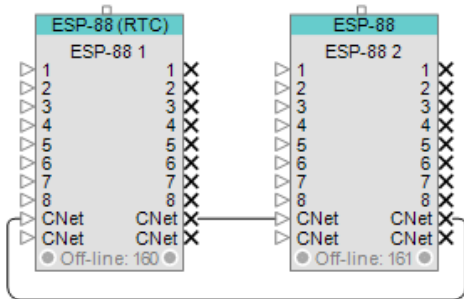

CobraNet 'wiring' within the Project View

- Verify the CobraNet configuration within the ESP. These options can be found in the Card Properties which are accessed by right-clicking on any CobraNet input or output module in ESP view and selecting 'Properties'. These are the default settings and should not require any changes.

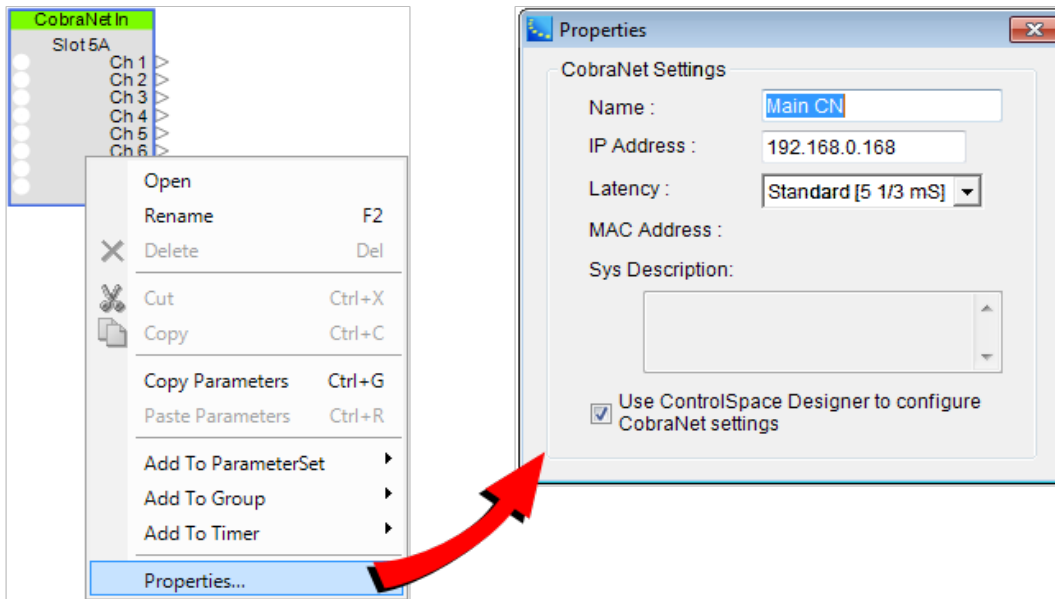

CobraNet Input/Output Properties

6. You will now determine how audio will be routed between ESP-88 #1 and ESP 88#2, by creating a Bundle assignment for the output section of ESP-88#1. This Bundle assignment will determine the method used to broadcast the digital audio on the network. To accomplish this open the CobraNet output control panel within ESP-88#1.

Once open, you can then assign a suitable Bundle number that will reference this group of eight channels. Since the connection is from a single transmitter (ESP-88 #1) to a single receiver (ESP-88 #2) a Unicast Bundle should be used from the range 256-65,279 to minimize network traffic.

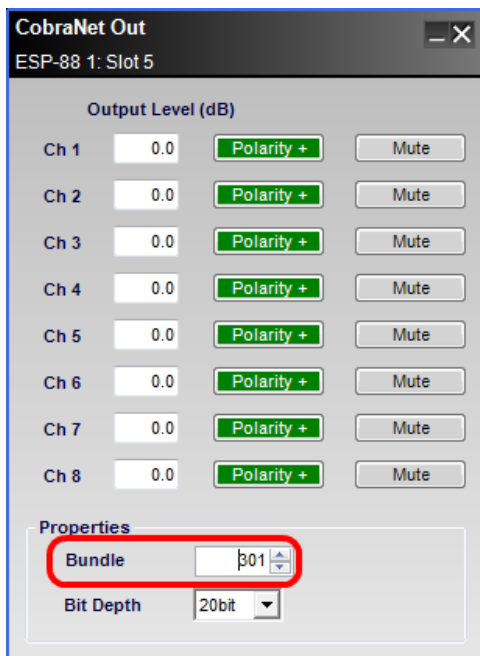

CobraNet Transmitter Bundle Assignment within ESP

NOTE: You can use any number within the Unicast range, 256-65,279, but typically it is easier to remember if it ends in '01' for the first link and '02' for the second link, (e.g. 301, 302 or 1001, 1002).

If desired the Bit depth can also be changed but the default of 20bit should be fine for most applications.

Now it is necessary to set up ESP-88 #2 to receive these 8 channels of audio. This is accomplished by configuring the CobraNet input of ESP-88 #2 to receive Bundle 301. Open the CobraNet input control panel in ESP-88 #2, and enter the new Bundle assignment.

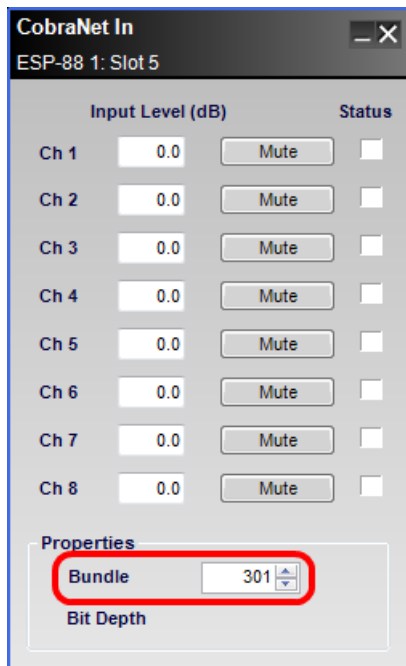

CobraNet Receiver Bundle Assignment within ESP

The previous two steps now need to be repeated to configure audio routing from ESP-88 #2 to ESP-88 #1. Note that the same Bundle assignment, 301 in this example, cannot be reused, and new Bundle assignment must be created, e.g. 302.

At this point the CobraNet configuration is complete and is ready, and once it is uploaded to the ESPs it should be possible to pass audio in both directions between them. To test this one could create a simple design using a source and a powered loudspeaker (or similar), passing the source to the second ESP and back again to prove that both connections are working.

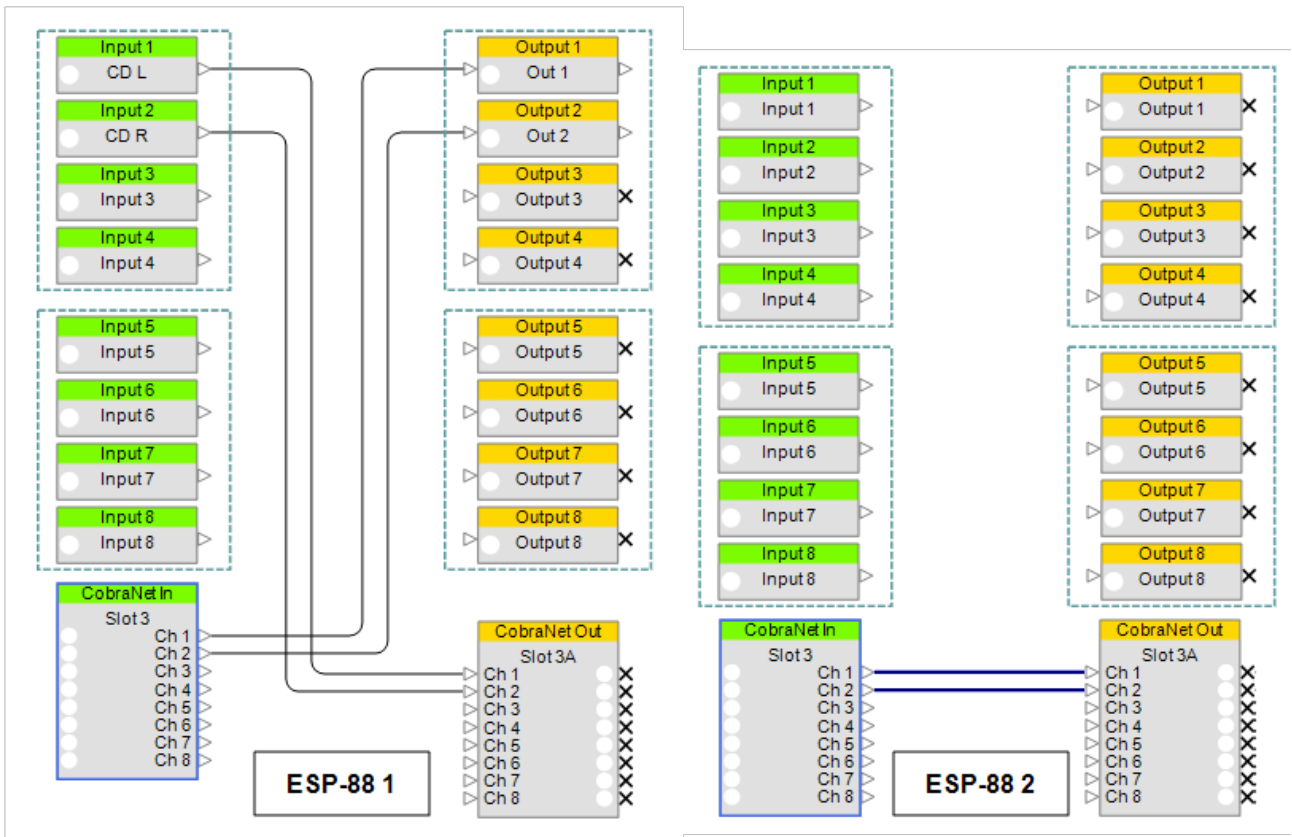

Simple audio configuration to test CobraNet connectivity

In addition to monitoring the audio signal level or listening to the audio output, the correct operation of the CobraNet links can also be verified using the CobraNet Status indicators on the input modules. These are not audio signal indicators; instead they indicate the presence of valid CobraNet data for each channel. When ControlSpace Designer is on-line the indicators will be green if there is a valid CobraNet connection.

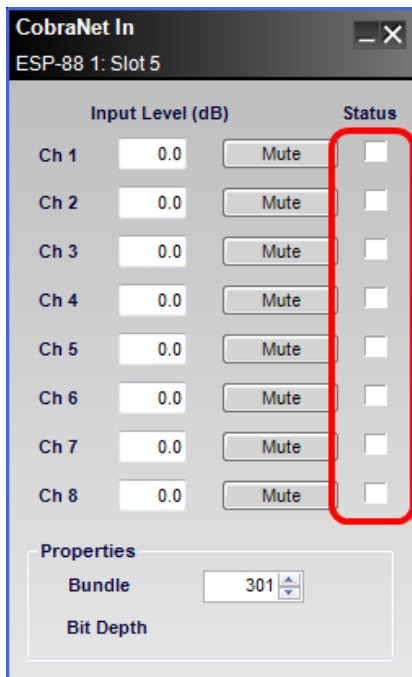

- Black:** Channel not being received
- Green:** Channel being received correctly
- Red:** Channel being received with errors (typically incorrect latency or network issues)

Example #2: ESP-to-Multiple PowerMatch® Amplifiers

IMPORTANT: CSD screens, buttons, icons, and product references in this topic are from CSD version 4.4.2.

In this more complex example, 2 Bundles and 16 channels of audio are distributed to two separate racks of PowerMatch amplifiers. This is a typical application where the ESP is located in a primary control room, while the amplifiers are located remotely throughout the facility.

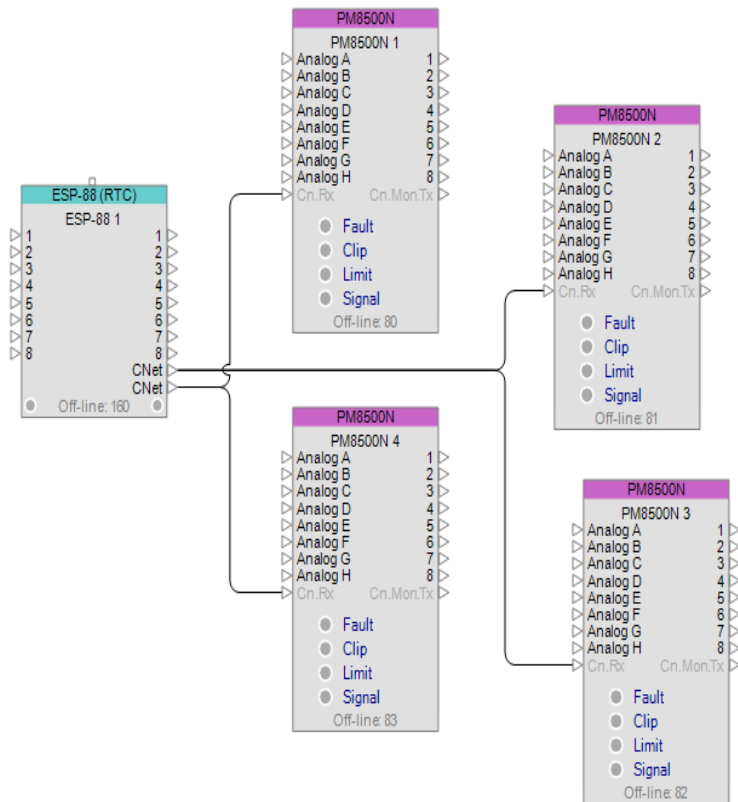

Example configuration for this example

Since this example involves sending multiple Bundles to PowerMatch amplifiers, some configuration of the PM CobraNet cards using the CobraNet Discovery utility will be required.

To configure this system, follow these steps:

1. Install the CobraNet cards and hook up independent networks for the CobraNet audio data and the ControlSpace control data.
2. Open ControlSpace Designer, start a new file and perform a 'Scan' of the hardware or add the ESP, PM amplifiers and CobraNet cards to Project View manually.
3. Select the ESP CobraNet card variant that most closely matches the project requirements in the ESP Properties. In this example it is configured as '16 out' so that two eight channel Bundles can be sent. The first transmitter will automatically be assigned Bundle number 100 (since it is the first CobraNet transmitter in the project), but the second transmitter will need to be assigned Bundle number 101 manually in the CobraNet Tx2 output module control panel.
4. Ensure that the ESP CobraNet card is set to 'Standard [5.33mS]' latency and that ControlSpace Designer has control over the CobraNet settings in the Card Properties (default settings).

5. Open the Input Control Panel for each PM amplifier and select 'Digital' source for each of the inputs.
6. Connect to the ControlSpace control network, send the design to the hardware and then disconnect.

NOTE: Since the PM CobraNet cards come pre-configured, all amplifiers should be receiving audio, but the audio is intended for amplifiers 1 & 2. Changing the Bundle assignment for amplifiers 3 and 4 requires the use of the CobraNet Discovery utility.

7. Swap the PC network connection to the CobraNet network, launch the CobraNet Discovery utility and ensure that all five CobraNet devices are present.

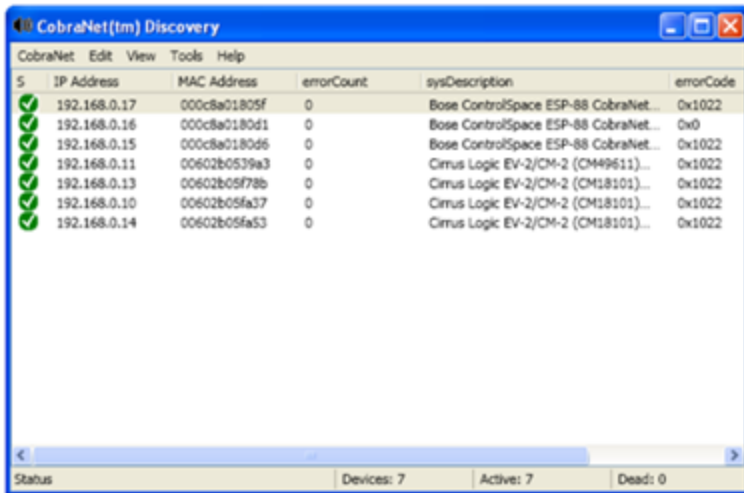

CobraNet Discover device view

8. Identify the PM CobraNet cards by temporarily disconnecting each in turn, making a note of the MAC address associated with each amplifier.
9. Assign a valid IP address to each of the PM CobraNet cards (Remember that IP addresses are only temporary).
10. With the cards identified double-click on the card for amplifier #3 to open the 'CobraNet Configuration' dialog.

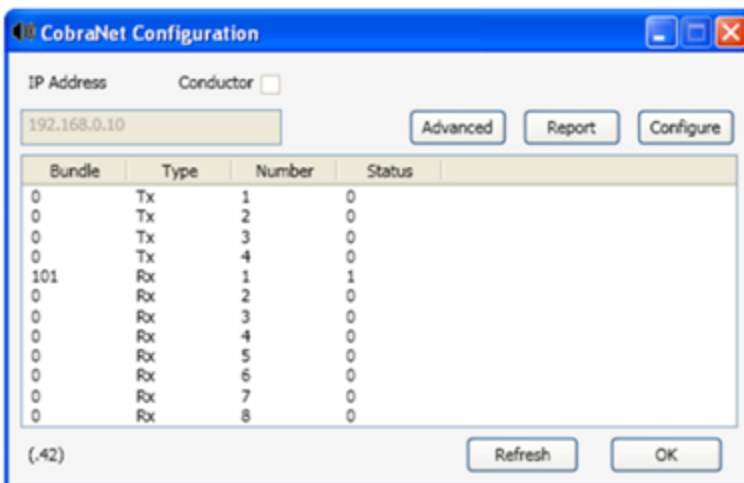

Configuration Parameters for PowerMatch amplifier

11. Then either select the row for Receiver 1 (Rx1) and click 'Configure' or simply double-click the row to open the 'Receiver 1 Configuration' dialog.

Since the card is already receiving valid audio data (audio for amplifiers 1 & 2) the status indicators should be green.

12. Change the Bundle assignment from '100' to '101' and then click 'Apply'.
13. To verify that the card is now receiving valid audio data from the second transmitter on the ESP click 'Refresh' and ensure that the status indicators are still green.

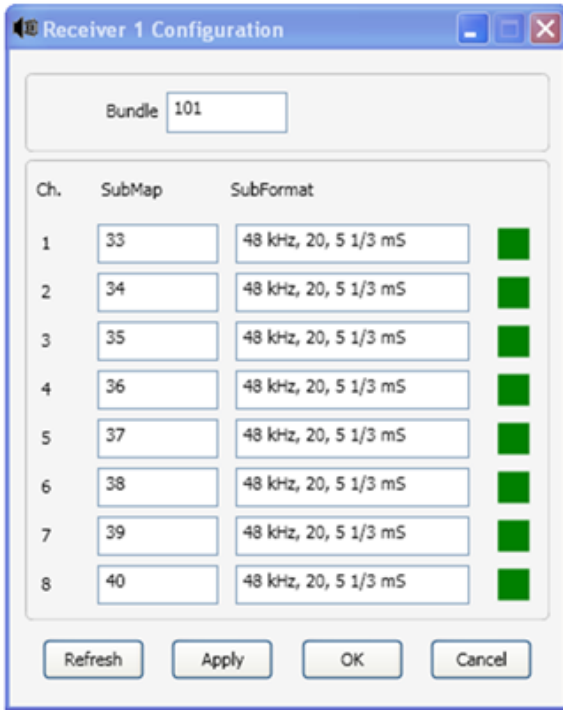

Configuration Panel showing new Bundle assignment and on-line status

14. Repeat steps 1-13 for amplifier #4 and the system then be configured and working as expected.